

# TABLE OF CONTENTS

CUSTOM DESIGN CAPABILITIES . . . . .	5
<b>TRADE NAME PRODUCTS &amp; CAPABILITIES . . . . .</b>	<b>11</b>
NEWtuf® Reinforced Silicone Rubber . . . . .	11
NEWind® Specialty Winding Wire . . . . .	11
NE-F1® Class F Insulation System . . . . .	12
NEWcel® Foamed Dielectrics . . . . .	12
NEWtral® Low-Noise Cables . . . . .	12
NEWlan™ Network Cables . . . . .	13
NEWguard™ Cables . . . . .	13
COLDflex Ground Cables™ . . . . .	13
HYflex™ Power Distribution Cables . . . . .	13
<b>MULTICONDUCTOR CABLES . . . . .</b>	<b>15</b>
Recommended Bunched Strands . . . . .	17
Recommended Ropelay Cables . . . . .	17
Ultra Flexible Silicone Rubber . . . . .	18
Ultra Flexible FEP & Silicone Rubber . . . . .	19
Ultra Flexible PVC . . . . .	21
Extra Flexible PVC . . . . .	23
PVC & PVC . . . . .	26
NEWguard™ Cables . . . . .	28
<b>MEDICAL CABLES . . . . .</b>	<b>31</b>
Medical Composite Cables . . . . .	33
Ultra Flexible Silicone Rubber . . . . .	36
Extra Flexible Silicone Rubber . . . . .	37
Ultra Flexible FEP & Polyurethane . . . . .	39
Ultra Flexible PFA & Silicone Rubber . . . . .	41
Ultra Flexible PFA Lead Wire . . . . .	43
Ultra Flexible FEP Stainless Steel . . . . .	44
Ultra Flexible PFA . . . . .	45
Ultra Flexible PVC . . . . .	47
NEWtral® Low-Noise Cables . . . . .	49
NEWtuf® Reinforced Silicone Rubber . . . . .	50
<b>INSTRUMENTATION/TEST &amp; MEASUREMENT CABLES . . . . .</b>	<b>51</b>
Instrumentation Composite Cables . . . . .	53
Ultra Flexible PFA & Silicone Rubber . . . . .	56
PFA & PFA . . . . .	58
FEP & TPE . . . . .	60
PVC & Polyester . . . . .	62
PVC & TPE . . . . .	64
PVC & Polyurethane . . . . .	66
PVC & PVC . . . . .	69
<b>COMMUNICATION &amp; CONTROL CABLES . . . . .</b>	<b>71</b>
Communication & Control Composite Cables . . . . .	73
FEP/PFA & Silicone Rubber . . . . .	76
PFA & TPE . . . . .	78
FEP & Polyester . . . . .	80
PVC & Polyurethane . . . . .	82
PVC . . . . .	84
NEWlan™ Networking Cables . . . . .	86
CATV, MATV, CCTV Coaxial Cables . . . . .	88
Alarm & Security . . . . .	88
<b>AUDIO/VIDEO CABLES . . . . .</b>	<b>89</b>
Audio Video Composite Cables . . . . .	91
HDMI . . . . .	95
Audio Video Cables . . . . .	96
<b>MICROMINIATURE &amp; MINIATURE COAXIAL CABLES . . . . .</b>	<b>97</b>
Microminiature 42-34 AWG . . . . .	99
Miniature 32-34 AWG . . . . .	99
NEWcel® Foamed Dielectrics . . . . .	101

<b>POWER LEADS/FLEXIBLE INTERCONNECT CABLES . . . . .</b>	<b>103</b>
Extra Flexible Silicone Rubber Grounding . . . . .	105
Extra Flexible PVC - 300 Volts . . . . .	106
Extra Flexible PVC - 600 Volts . . . . .	106
Ultra Flexible Miniature Silicone Rubber . . . . .	107
Extra Flexible Silicone Rubber Lead 600 Volt . . . . .	108
Extra Flexible Silicone Rubber Lead 1000 Volt . . . . .	109
Ultra Flexible Micro & Miniature PVC . . . . .	110
Extra Flexible PVC Lead - 600 Volts . . . . .	111
PVC Lead - 1000 Volts . . . . .	112
PVC Lead - 3000 Volts . . . . .	112
Ultra Flexible Microminiature FEP 150 V . . . . .	113
FEP Lead Wire - 300 Volts . . . . .	114
FEP Lead Wire - 600 Volts . . . . .	115
FEP Lead Wire - 1000 Volts . . . . .	116
UL 1007 PVC . . . . .	117
UL 1015 PVC . . . . .	118
UL 1032 PVC . . . . .	119
UL 1662 PVC . . . . .	120
UL 3123 Silicone Rubber . . . . .	121
UL 3132 Silicone Rubber . . . . .	122
HYflex™ Power Distribution Cables . . . . .	123
COLDflex Ground Cables™ . . . . .	124
PVC Ground Strap . . . . .	125
<b>LITZ &amp; WINDING WIRE . . . . .</b>	<b>127</b>
Litz Wire Types & Constructions . . . . .	129
Litz Wire Info Page . . . . .	130
Round Litz . . . . .	132
Rectangular Braided Litz . . . . .	137
Rectangular Compacted Litz . . . . .	138
Single Film Coated-Round . . . . .	144
Heavy Film Coated-Round . . . . .	145
Film Insulations . . . . .	146
Fiber & Tape Insulations . . . . .	147
NEWind® Specialty Winding Wire . . . . .	148
NEWind® Solid/PFA . . . . .	149
NEWind® Solid/FEP . . . . .	150
NEWind® Solid/ETFE . . . . .	151
NE-F1® Class F Electrical Insulation System . . . . .	152
<b>BRAIDS, CABLES &amp; STRANDS . . . . .</b>	<b>153</b>
Braids Intro . . . . .	155
Standard Braided Copper Cables . . . . .	156
Extra Wide Braided Copper Cables . . . . .	157
Extra Flexible Round Copper Cables . . . . .	158
Tinned Copper Braids (Flat) . . . . .	159
Nickel-Plated Copper Shielding Braids . . . . .	159
Tinned Copper Shielding Braid (Tubular) . . . . .	160
Silver-Plated Copper Shielding . . . . .	161
Tinned Copper Oval Shielding . . . . .	162
Stainless Steel Shielding . . . . .	162
Cross Reference Guide . . . . .	163
PVC Insulated Ground Strap . . . . .	165
Cables & Strands Intro . . . . .	166
Extra Flexible Ropelay Strands . . . . .	167
Standard Concentric & Unilay . . . . .	169
<b>TECHNICAL REFERENCE . . . . .</b>	<b>171</b>
Raw Materials . . . . .	173
UL . . . . .	174
Alloy Information . . . . .	175
Annealed Bare & Silver-Plated Copper . . . . .	176
Annealed Tinned Copper - Round . . . . .	177
Single Film Coated-Round . . . . .	178
Heavy Film Coated-Round . . . . .	179
NEWtuf® Reinforced Jackets . . . . .	180
NEWcel® Foamed Dielectrics . . . . .	181
NEWtral® Low-Noise Cables . . . . .	182
NEWind® Specialty Winding Wire . . . . .	183
NE-F1® Class F Insulation System . . . . .	184
COLDflex Ground Cables™ . . . . .	185
NEWlan™ Networking Cables . . . . .	186
NEWguard™ Cables . . . . .	188
HYflex™ Power Distribution Cables . . . . .	190
Glossary . . . . .	191

CREATIVE ENGINEERING.  
AGILE MANUFACTURING.

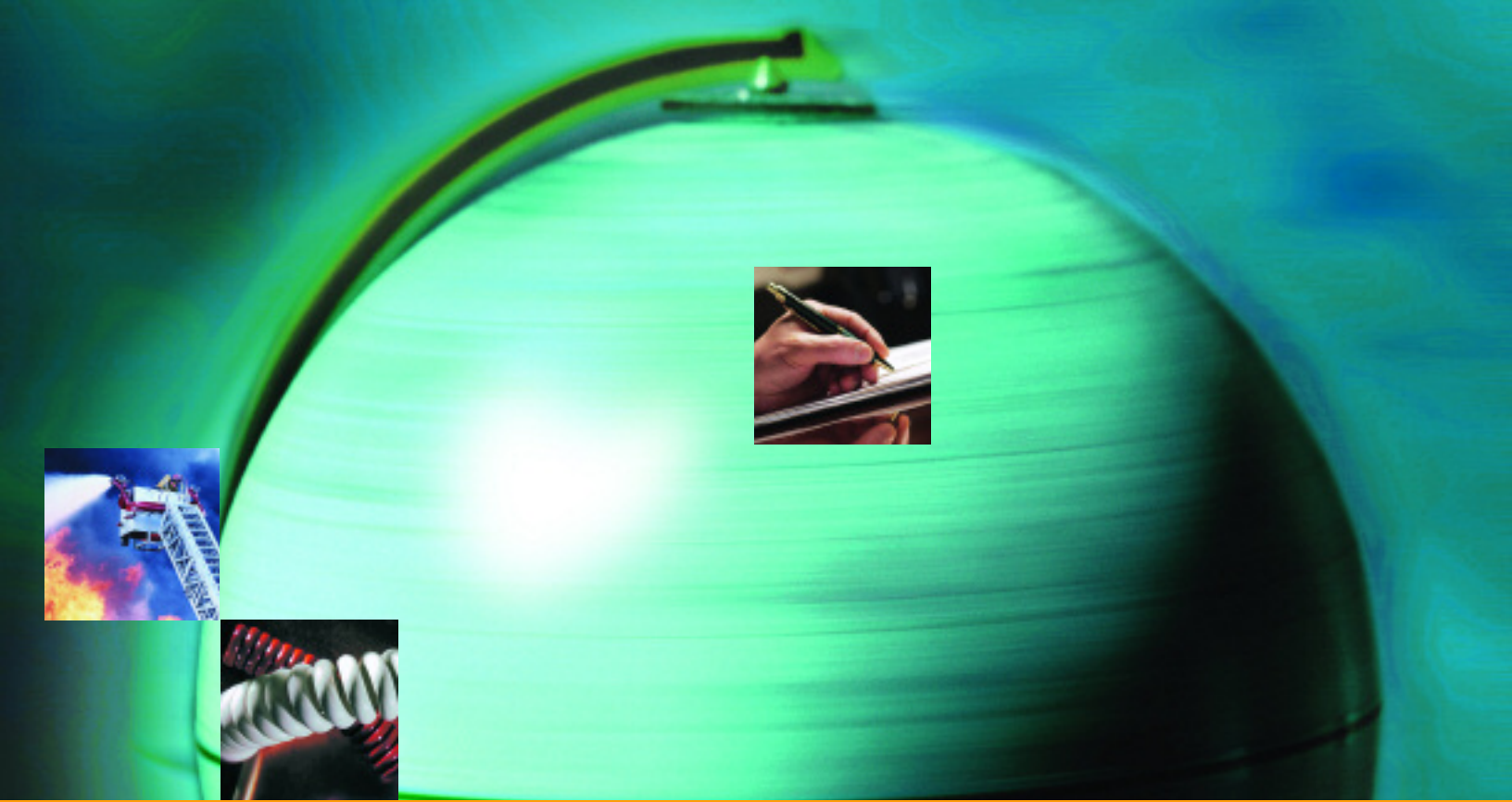

A WORLD OF SOLUTIONS FOR  
INDUSTRIAL, SCIENTIFIC  
AND MEDICAL APPLICATIONS.

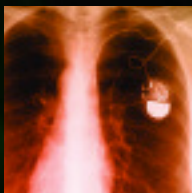

## COMPANY PROFILE

Whether you need a reliable source for quality wire and cable or customized solutions to improve the performance of your products, the best place to turn is New England Wire Technologies.

For more than one hundred years, we have designed, developed, tested and manufactured custom wire and cable solutions to meet the needs of engineers, scientists and technical professionals around the world. Our cumulative experience and in-depth knowledge make us the best partner you can have when faced with complex design and challenging projects.

### ONE-OF-A-KIND SOLUTIONS.

New England Wire Technologies creates highly customized wire and cable products for a diverse range of industrial, scientific and medical industries; all are designed to meet the precise requirements of your most demanding specifications. Many are one-of-a-kind. Our technical staff works with you every step of the way—from initial design and development to testing and manufacturing—to deliver quality custom wire and cable solutions you can rely on when your reputation is on the line.

### MAKE THE RIGHT CHOICE.

New England Wire Technologies offers you proven engineering and manufacturing expertise; everyone at New England Wire is committed to helping you improve the quality and performance of your products.

New England Wire Technologies started out as a manufacturing organization at the dawn of the telecommunications age and we've continually advanced the state of the art ever since. Today, we design and manufacture an extensive range of sophisticated wire and cable products—from multiconductor, superconductor and coaxial cable to Litz wire, braids, coiled cords, fine-wire strands and flexible interconnects.

### SPEED YOUR TIME TO MARKET.

Thanks to the expertise of our people and the true vertical integration of our manufacturing approach, we can ensure that your design-to-market curve is the shortest in the wire and cable industry. We design and build most of our own equipment and tooling, so we can offer a level of manufacturing agility that yields custom wire and cable products of exceptionally high quality in remarkably fast time frames.

### QUALITY YOU CAN COUNT ON.

New England Wire Technologies has earned both ISO 9001 and TS16949 registration—a testimony to the fact that quality control is the focus of every employee. We have the broadest and deepest in-house technical expertise and manufacturing know-how in the wire and cable industry so we're able to maintain the highest standards of quality every step of the way—from research to inspection of raw materials to inline testing.

In fact, the majority of ownership is held by our skilled and dedicated employees who are passionate about delivering intelligently designed, well crafted wire and cable products that perform best when they're needed most.

While this catalog provides you with an overview of our wide range of products and capabilities, we encourage you to visit [www.newenglandwire.com](http://www.newenglandwire.com), or contact our sales department by phone or e-mail to discuss your current challenges.

Discover how New England Wire Technologies can help you innovate, create, and accelerate the success of your business.

### WHAT'S INSIDE?

Overview	Audio/Video Cables
Custom Design & Trade Name Products	Microminature & Miniature Coaxial Cables
Multiconductor Cables	Power Leads/Flexible Interconnect Cables
Medical Cables	Litz & Winding Wires
Instrumentation/Test & Measurement Cables	Braids, Cables, Strands
Communications & Control Cables	Technical Reference

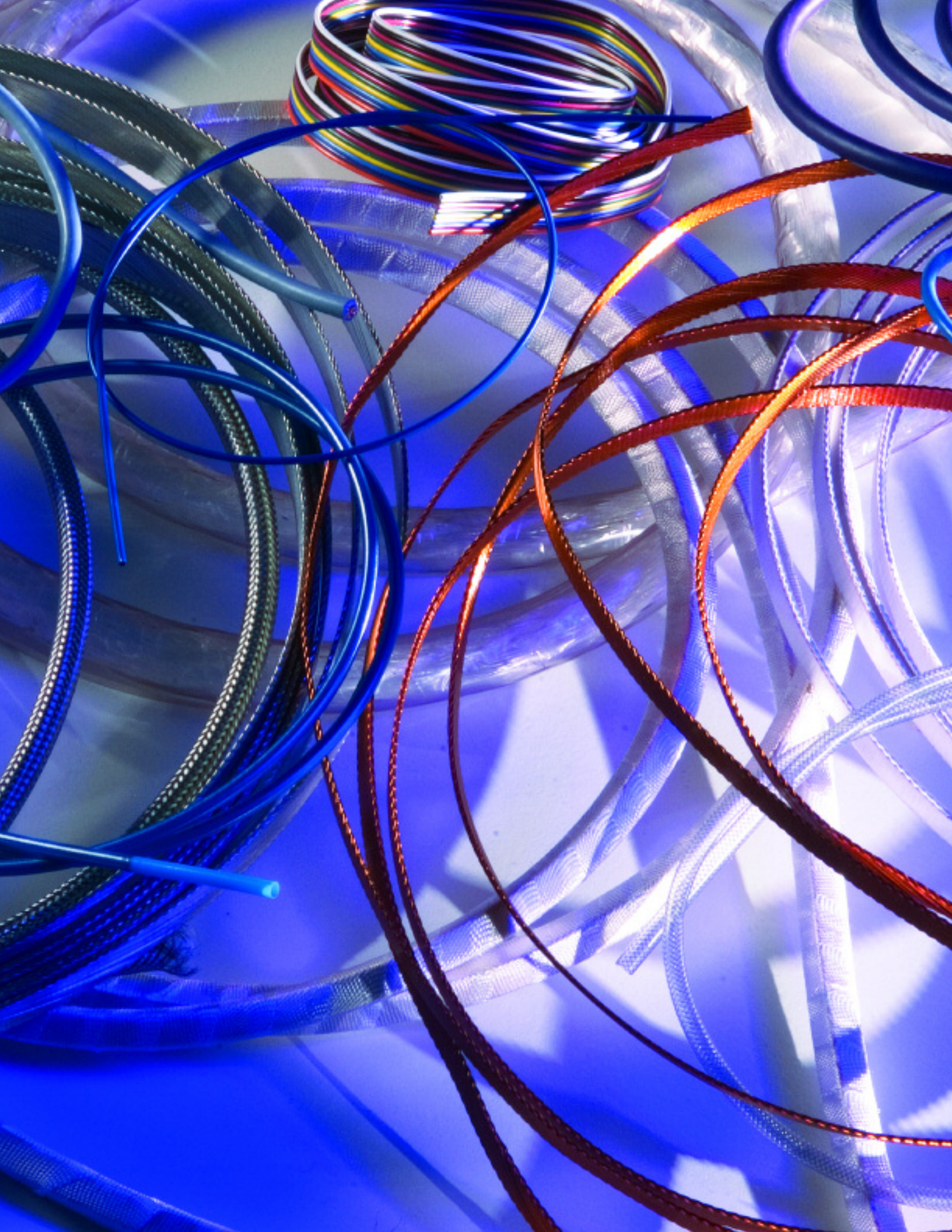

# CUSTOM DESIGN & TRADE NAME PRODUCTS

## OUR CUSTOM SERVICES INCLUDE:

### DEVELOPMENT ASSISTANCE

New England Wire Technologies welcomes all opportunities to assist in the design, development, testing and manufacture of custom wire and cable products. If your requirements include materials that are not listed in our catalog, please contact us to review your specific needs.

### CATHETERS

New England Catheter, our medical products group, draws on a unique set of core technologies to design and produce precision custom reinforced tubing built to the exacting standards of medical device organizations.

### ASIA SALES AND MANUFACTURING

Our production facility in China has increased New England Wire's capacity by 50%. We can now better serve our customers with manufacturing operations in Asia through our sales office in Guangzhou City. Plus, we can cost effectively offer higher volume, less complex customized products to all our customers.

Off-the-shelf components may work for some applications, but when wire and cable are critical to the performance of your product, you can't settle for anything less than custom solutions.

With decades of research, testing and development under our belt, New England Wire Technologies is uniquely qualified to offer custom design, development, testing and manufacture of specialty wire products using a wide variety of materials. We employ our reiterative design process, concurrent engineering and rapid prototyping to quickly bring ideas from the drawing board to the production line—one solution at a time.

### QUALITY CERTIFICATION

New England Wire Technologies has earned both ISO 9001:2000 and TS16949:2002 Registration, so you're assured that your custom wire and cable products meet the highest standards of the most demanding independent quality organizations.

### RoHS COMPLIANCE

New England Wire Technologies is dedicated to offering technical solutions and superior materials that minimize environmental impact and maximize the performance benefits of our custom-designed, specialty wire and cable. We have identified the current RoHS status of our existing products and offer a variety of GreenLine materials to meet the needs of our customers who request compliance.





## CUSTOM DESIGN CAPABILITIES

The keys to our success in specialty wire manufacturing are the expertise and dedication of our workforce and the variety and flexibility of our equipment. Our technical staff expertly assists customers in the development and testing of all our custom products. Every machine operator is a skilled craftsman with the experience and knowledge necessary to independently gather components, configure machinery and monitor quality control—regularly completing several discreet production runs in a single work day. It is this talent pool of owner/employees combined with an unparalleled array of equipment that enables New England Wire to offer custom wire products of exceptionally high quality, in quantities that suit specialty manufacturing needs, and in time frames that meet critical production schedules.

We have developed a number of trade name products to help solve engineering challenges for a broad spectrum of high-performance applications in a diverse array of disciplines including automotive, communications, computers, high-energy physics, medical electronics, nuclear fusion research, public utilities and defense. Our trade name products are further evidence of our commitment to creating custom design capabilities and high-quality, technically advanced cables you can rely on no matter how challenging your application or environment.

**TESTING** Our on-site testing facilities are among the finest in the industry. Seasoned technicians in our state-of-the-art lab can test cables according to military or other custom specifications. We continually conduct research and testing to improve materials, processes and end products.

**COLOR MATCHING** We maintain a wide range of color concentrates for numerous extruded insulations to create custom colors for your applications. Both color matching and batch testing are offered in our development lab.

**CUSTOM PRINTING** New England Wire offers a complete range of printing services including print wheel and ink jet printing. Our custom services can be used to imprint cable with your company name and logo or to meet requirements of UL/CSA.

**TOLL ORDERS** We're happy to accept and work with your material for special projects. Please contact New England Wire Technologies to discuss your application.

## CUSTOM DESIGN CAPABILITIES, *continued*

**MULTICONDUCTOR CABLES** New England Wire Technologies is a world leader in the design and manufacture of multiconductor cable for specialty applications. Our multiconductor cables are used in diverse applications such as medical electronics, robotics, defense electronics, power distribution, and computer peripherals. Cables with requirements such as flexibility, extended flex life, high/low temperature performance, miniaturization and unusual combinations of conductor sizes are made to order in both shielded and unshielded configurations. Our broad range of manufacturing capabilities and wide selection of conductor and insulation materials allow us to design wire and cables to meet the most demanding customer specification.

**LITZ WIRE** Our expertise in producing Litz wire is unmatched for specialty applications such as high frequency inductors and transformers, inverters, communications equipment and ultrasonic and sonar equipment.

**FLEXIBLE INTERCONNECTS** For power distribution applications, flexible interconnect conductors are manufactured in sizes up to 4/0 AWG with a full range of specialty stranding and insulation options.

**COAXIAL CABLES** Specialty coaxial cables can be manufactured in a range of sizes from miniature 42 AWG PFA insulated (.33 mm O.D.) to 8 AWG low-loss with expanded PTFE tape dielectric.

**BRAIDS** Flat, tubular and round braids are manufactured to standard or custom specifications. Braided products can also be supplied with a variety of extruded insulations.

**CABLES & STRANDS** Our fine-wire technology enables the manufacturing of uninsulated strands and ropelay cables in various gauges and conductor materials.





## CUSTOM DESIGN CAPABILITIES, *continued*

### FORMED CABLES

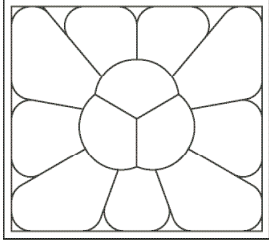

New England Wire manufactures formed, or compacted, cables, with copper densities as high as ninety percent, which have been used in applications such as high-efficiency generators and linear motors.

These cables are most often made with either bare copper, or magnet wire, and are formed to various profiles, which allow our customers to maximize the fill factor of their windings. In addition to wire, copper tubing used for cooling has been incorporated into some of our formed cable designs.

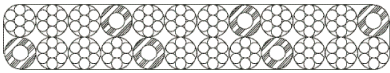

Tape wraps and textile servings are available and in some cases extruded plastics are offered for additional voltage withstand. Please contact our design team for more information.

### SUPERCONDUCTOR

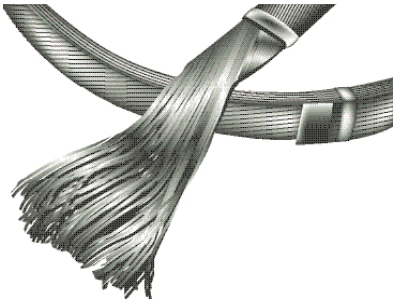

New England Wire Technologies has provided cabling, insulating and other services to the superconductor industry since the 1960's. In fact, our products are integrated into most of the major accelerator projects, as well as ore separator magnets, NMR magnets, and superconducting magnetic energy storage (SMES) magnets. We have experience with both low temperature and high temperature conductors, and we're a world leader in Rutherford cabling of superconducting wire. We have the ability to apply polyimide tape, fiberglass tape, fiberglass textile braid, extruded ETFE insulation and engineered materials to all conductor configurations. Call our design team to discuss your specific requirement.

### COILED CORDS

From the late 1980's through 2000 New England Wire produced a broad range of custom coiled cords at its Lisbon, New Hampshire plant. With the formation of our subsidiary, New England Interconnect Systems in the year 2000, most of the processing equipment was moved to NEI Systems in Keene, New Hampshire and Santa Ana, Sonora, Mexico.

New England Wire continues to manufacture silicone rubber-jacketed coiled cords in its Lisbon plant. NEI Systems, in addition to producing a wide range of custom cable assemblies using both straight and coiled cables, makes custom coil cords using cables jacketed with PVC, Polyurethane, Polyester, and a variety of TPE compounds.

[www.newenglandwire.com](http://www.newenglandwire.com)

Tel: 603.838.6624

## CUSTOM DESIGN CAPABILITIES, *continued*

### CATHETERS

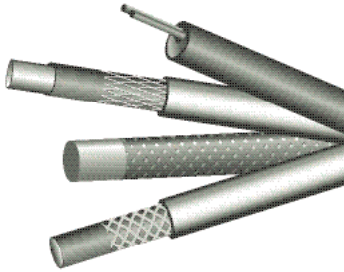

Our subsidiary, New England Catheter works with clients to custom design products based on the unique product performance characteristics required. Braid reinforced tubing, lubricious lined catheter shafts and tubing that utilizes conductors or linear strength members are examples of products we manufacture using our advanced extrusion expertise and extensive in-house wire processing capabilities. We specialize in the design and manufacture of thin-wall tight tolerance extrusion, multi-lumen braided tubing and tubing with layers of thermoplastic resins bonded to layers of fluoropolymer resins. Round or flat stainless steel wire, high strength fiber materials, plastic monofilament and a number of other materials can be used as the braided reinforcement component of most tubing products.

New England Catheter has manufactured tubing as small as .035" OD up to 1.00" OD using fluoropolymers, nylon, polyurethane, Pebax®, polyethylene, PVC and most other thermoplastic compounds. We stock stainless steel wire from .0015" to .010" in diameter and flat wire from .001"x.002" to .003"x.012" in hard and soft tempers for braiding using 8, 12, 16, 24, 32 and 48 carriers.

Our products have been used in almost every arena of medical projects: anesthesiology, angiography, angioplasty, biopsy devices, cardiovascular, dental, endoscopy, neurology and pain management to name a few. We are proud to have the most extensive braiding and wire handling capabilities to be found at a catheter manufacturer anywhere. Call our design staff at (603) 838-2261 or visit [www.necatheter.com](http://www.necatheter.com) to get started on your project.



## TRADE NAME PRODUCTS & CAPABILITIES

Our trade name products are designed to cover a broad spectrum of high-performance applications, each designed with its own unique characteristics. For example, NEWtuf® cables are typically used in medical applications due to their high axial tensile strength, superior flexibility and ease of sterilization. NEWind® Winding Wires eliminate the need for separate ground, interwinding, and turn insulation in transformers, motors and coil designs. NE-F1 Insulation System is our UL approved electrical insulation system of high-performance winding wires. NEWtral® low noise cables neutralize noise generated by mechanical shock and vibration. NEWcel® is a closed-cell foamed material that provides a significantly reduced dielectric constant in ultra-miniature coaxial, twinaxial and triaxial cables. And our COLDFlex Ground Cable™ makes handling easy even in harsh weather—as low as -40°C.

Contact our design team to discuss your toughest wire and cable challenges; we specialize in custom solutions for your unique application.

### **NEWtuf® REINFORCED SILICONE RUBBER**

Does your product require high axial strength under extreme conditions like operating rooms and trauma centers? NEWtuf® custom cables deliver peak jacket strength three times that of conventional silicone rubber jacketed cables.

They help eliminate damage from pulling and stretching, yet maintain their flexibility even after repeated exposure to high temperatures, solvent sterilization and autoclaving. While tougher than conventional silicone rubber, NEWtuf® jackets can be easily stripped with standard equipment.

### **NEWind® SPECIALTY WINDING WIRE**

Commonly used in power conversion and other applications requiring additional voltage-withstand, our specialty transformer winding wires (to UL 60950 Annex U and VDE IEC 60950) are available in supplementary and reinforced constructions.

NEWind® Specialty Winding Wire solves the problem of damage to the insulation between winding turns by coating the conductors with multiple thin layers of insulation so defects in any one layer will not reduce insulation ability. The result? You can manufacture smaller, less costly motors and transformers because there is no need for additional interleaved insulation.

## TRADE NAME PRODUCTS & CAPABILITIES, *continued*

### **NE-F1® ELECTRICAL INSULATION SYSTEM**

Class F (155°C) is our electrical insulation system of high-performance winding wire products designed to meet UL 1446 Electrical Insulation System for double- and triple-insulated winding wires.

NE-F1® features a wide variety of bobbin materials, tapes, sleeving, potting compounds and varnishes. This diverse selection of materials ensures that NE-F1® will be suitable for most Class F devices, thus reducing the need for multiple Electrical Insulation Systems.

### **NEWcel® FOAMED DIELECTRIC**

In nature, air is near-perfect dielectric medium, allowing a signal to move through it at a rate approaching the speed of light, however, an air dielectric is impractical for use as a cable insulation as it provides no structural integrity. But NEWcel® is the ideal solution. This closed-cell foamed dielectric material is specifically designed to reduce the dielectric constant and dissipation factor, yielding low-capacitance, low-loss, high V.O.P. ultra miniature coaxial, twinaxial and triaxial cables.

Using highly controlled extrusion processes, we foam material with a low dielectric constant (2.0 - 2.6) to produce a dielectric medium with a high air concentration. This results in a significantly reduced dielectric constant (1.45 - 1.8) while providing the customer with the choice of reduced diameter and same attenuation or same diameter and reduced attenuation without sacrificing structural integrity.

### **NEWtral® LOW NOISE CABLE**

New England Wire Technologies creates cables specifically designed to neutralize noise generated by mechanical shock and vibration and maximize critical signal quality in small-signal applications.

Our state-of-the-art low-noise cables can be found in a range of medical devices such as ECG, EEG and pulse oximetry equipment, as well as test and measurement tools including charge amplifiers, vibration analyzers and oscilloscopes. New England Wire Technologies' engineers can design custom cables to meet all your performance requirements.



## TRADE NAME PRODUCTS & CAPABILITIES, *continued*

### **NEWlan™ NETWORK CABLES**

Our networking cables have the high bandwidth you need for current 1G applications as well as emerging standards like IP-based full motion video, IP-based security, Voice Over IP and 10G Ethernet applications. So your investment in networking cable is fully protected.

Our enhanced CAT-6E Gold cables comply with TIA/EIA 568-8 and ISO/IEC 11801 Class E standards while offering the ultimate in attenuation, cross-talk, signal-to-noise ratio and return loss performance.

### **NEWguard™**

Our NEWguard™ cables are custom designed for the most challenging and demanding environments. In extreme conditions, cable becomes a critical link that supplies low voltage power, control and data signals. NEWguard™ cable remains flexible while meeting environmental challenges such as extreme temperature, mechanical abuse, presence of strong chemicals, exposure to oils, dust, wind, salt water spray and vibration.

### **COLDflex GROUND CABLE™**

Our custom compound gives COLDflex Ground Cable™ the voltage rating, dielectric strength, temperature rating and flexibility to make handling easy — even at temperatures as low as -40°C. This allows you to get grounding cables off the reel and quickly installed in cold weather.

### **HYflex™ Power Distribution Cables**

HYflex™ power distribution cables incorporate a uniquely designed, high performance insulation specifically formulated for use in heavy duty diesel hybrid vehicles and high strand count, flexible conductors to produce cables ideally suited for applications where flexibility, long life and performance is critical.





## MULTICONDUCTOR CABLES

New England Wire Technologies creates multiconductor cables for applications as diverse as medical electronics, robotics, defense electronics, power distribution and computer peripherals.

We draw on our broad range of manufacturing capabilities and our in-depth knowledge of conductor and insulation materials to produce cables that deliver precisely what you're looking for—low noise, high flexibility, extended flex life, miniaturization, high/low temperature performance and resistance to oils and corrosive chemicals.

For example, we develop low-noise cables used in medical applications like patient monitoring devices, electro-surgical instruments, nerve stimulation devices, pacemaker and pulse oximetry, where noise-free transmission is important to maintaining signal quality. We also combine finely stranded conductors and thin-wall extrusions to create highly flexible cables for applications where unrestricted motion of an instrument is vital.

Whether you're looking for cables designed for low noise, high or low temperature, extended flex life, ultra flexibility, miniature size, vented cables or bonded, flat cables, New England Wire Technologies has the design and manufacturing expertise to produce cables that perform when the mission is critical.



## MULTICONDUCTOR CABLES

New England Wire Technologies is a world leader in the design and manufacture of multiconductor cable for specialty applications such as medical electronics, robotics, defense electronics, power distribution, and computer peripherals. Our broad range of manufacturing capabilities and wide selection of conductor and insulation materials allow us to produce cables that have extra flexibility, extended flex life, miniaturization, low and high temperature ratings, and resistance to oils and corrosive chemicals.

Recommended Bunched Strands . . . . .	17
Recommended Ropelay Cables . . . . .	17
Ultra Flexible Silicone Rubber . . . . .	18
Ultra Flexible FEP & Silicone Rubber . . . . .	19
Ultra Flexible PVC . . . . .	21
Extra Flexible PVC . . . . .	23
PVC & PVC . . . . .	26
NEWguard™ Cables . . . . .	28



## Recommended Bunched Strands for Maximum Flexibility

Equivalent AWG	Circular Mil Area	Number of Wires	AWG Size	Nominal OD	Approximate Feet/LB	Approximate LBS/1000 FT
42	7.0	7	50	.003	47619	.0210
40	9.8	10	50	.004	33003	.0303
38	17.0	17	50	.005	19455	.0514
36	26.0	26	50	.006	12706	.0787
36	28.2	11	46	.006	11947	.0837
34	41.0	41	50	.007	8058	.1241
34	41.0	16	46	.007	8210	.1218
34	40.0	10	44	.007	8097	.1235
32	65.0	65	50	.009	5083	.1967
32	66.6	26	46	.009	5053	.1979
32	64.0	16	44	.009	5060	.1976
30	105.0	41	46	.012	3205	.3120
30	100.0	25	44	.012	3239	.3087
30	105.7	11	40	.012	3063	.3264
29	133.1	52	46	.013	2527	.3957
28	166.4	65	46	.015	2021	.4947
28	160.0	40	44	.015	2024	.4940
28	153.8	16	40	.014	2106	.4747
26	264.0	66	44	.019	1226	.8151
26	249.9	26	40	.018	1296	.7714
24	403.6	42	40	.023	802	1.246
22	634.3	66	40	.029	510	1.958
22	650.0	26	36	.029	498	2.007
20	1050.0	42	36	.037	308	3.242
18	1625.0	65	36	.047	199	5.017

## Recommended Ropelay Cables for Maximum Flexibility

Equivalent AWG	Circular Mil Area	Construction	Number of Wires	AWG of Wire	Nominal OD	Approximate Feet/LB	Approximate LBS/1000 FT
26	268.8	3X35/46	105	46	.020	202	.8148
26	268.8	7X15/46	105	46	.020	197	.8148
26	264.0	3X22/44	66	44	.020	192	.8311
24	420.0	3X35/44	105	44	.025	225	1.322
24	420.0	7X15/44	105	44	.025	227	1.322
23	600.0	3X50/44	150	44	.030	315	1.889
22	672.0	7X24/44	168	44	.032	307	2.115
22	634.3	3X22/40	66	40	.031	394	1.997
20	1036.0	7X37/44	259	44	.040	473	3.261
20	1009.1	7X15/40	105	40	.039	529	3.177
19	1400.0	7X50/44	350	44	.046	756	4.407
19	1412.7	7X21/40	147	40	.046	756	4.447
18	1652.0	7X59/44	413	44	.050	1203	5.201
18	1614.5	7X24/40	168	40	.050	1227	5.082

All measurements are in inches unless otherwise stated.

[www.newenglandwire.com](http://www.newenglandwire.com)

Tel: 603.838.6624

# Ultra Flexible Single & Multiconductor Silicone Rubber Insulated Cables 300 Volts, 150° C

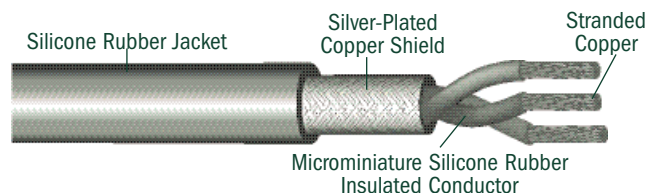

**DESCRIPTION:** Conductors are ultra flexible tin- or silver-plated copper strands insulated with 10 mil walls of silicone rubber. Extra flexible silver-plated copper braided or spiral shields, silicone rubber jackets or both can be applied over the cabled conductors.

**USE:** For use on various medical instruments where ultra flexibility and small diameters are desired. Recommended for industrial applications where higher temperature ratings and extreme flexibility are required. Please contact our design team for your specific application requirements.

Number of Conductors	SINGLE CONDUCTOR DATA				Nominal Diameter Over Cabled Conductor	SHIELD		JACKET	
	Equivalent AWG	Strand Construction	Nominal Wall Thickness	Nominal Diameter		AWG of Shield	Nominal Diameter Over Shield	Nominal Wall Thickness	Nominal OD
1	36	26/50	.010	.026	.026	44	.035	.010	.055
1	34	41/50	.010	.027	.027	44	.036	.010	.056
1	33	52/50	.010	.028	.028	44	.037	.010	.057
1	32	65/50	.010	.029	.029	44	.038	.010	.058
1	31	75/50	.010	.030	.030	44	.039	.010	.059
1	30	41/46	.010	.032	.032	44	.041	.010	.061
1	29	52/46	.010	.033	.033	44	.042	.010	.062
1	28	65/46	.010	.035	.035	44	.043	.010	.063
2	36	26/50	.010	.026	.051	44	.060	.010	.080
2	34	41/50	.010	.027	.053	44	.062	.010	.082
2	33	52/50	.010	.028	.055	44	.064	.010	.084
2	32	65/50	.010	.029	.057	44	.066	.010	.086
2	31	75/50	.010	.030	.059	44	.068	.010	.088
2	30	41/46	.010	.032	.063	44	.072	.010	.092
2	29	52/46	.010	.033	.065	44	.074	.010	.094
2	28	65/46	.010	.035	.067	44	.076	.015	.106
3	36	26/50	.010	.026	.056	44	.065	.015	.095
3	34	41/50	.010	.027	.058	44	.067	.015	.097
3	33	52/50	.010	.028	.060	44	.069	.015	.099
3	32	65/50	.010	.029	.062	44	.071	.015	.101
3	31	75/50	.010	.030	.065	44	.074	.015	.104
3	30	41/46	.010	.032	.069	44	.078	.015	.108
3	29	51/46	.010	.033	.071	44	.080	.015	.110
3	28	65/46	.010	.035	.075	44	.084	.015	.114
4	36	26/50	.010	.026	.063	44	.072	.015	.102
4	34	41/50	.010	.027	.065	44	.074	.015	.104
4	33	52/50	.010	.028	.067	44	.076	.015	.106
4	32	65/50	.010	.029	.070	44	.079	.015	.109
4	31	75/50	.010	.030	.072	44	.081	.015	.111
4	30	41/46	.010	.032	.077	44	.086	.015	.116
4	29	52/46	.010	.033	.080	44	.089	.015	.119
4	28	65/46	.010	.035	.084	44	.093	.015	.123
5	36	26/50	.010	.026	.070	44	.079	.015	.109
5	34	41/50	.010	.027	.073	44	.082	.015	.112
5	33	52/50	.010	.028	.076	44	.085	.015	.115
5	32	65/50	.010	.029	.079	44	.087	.015	.118
5	31	75/50	.010	.030	.081	44	.090	.015	.120
5	30	41/46	.010	.032	.086	44	.095	.015	.125
5	29	52/46	.010	.033	.089	44	.098	.015	.128
5	28	65/46	.010	.035	.095	44	.104	.020	.144

Our standard colors for primary and overall jackets include: white, black, red, green, yellow, blue, brown, orange, gray and violet. Custom color and/or exact color match available; please contact our design team for your specific requirement.

All measurements are in inches unless otherwise stated.

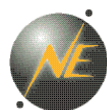

NEW ENGLAND WIRE TECHNOLOGIES  
Innovate. Create. Accelerate.

# Ultra Flexible Single & Multiconductor FEP & Silicone Rubber Insulated Cables 250 Volts, 150° C

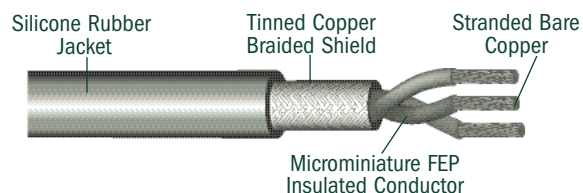

**DESCRIPTION:** Conductors are ultra flexible bare copper strands insulated with a 5 mil wall of FEP. Extra flexible tin-plated copper braided shields may be applied prior to jacketing with 10 mil wall of silicone rubber overall.

**USE:** Miniature relays, medical instruments and other specialized electronic applications requiring ultra flexible microminiature multiconductor cables. Please contact our design team for your exact requirement.

Number of Conductors	SINGLE CONDUCTOR DATA				Nominal Diameter Over Cabled Conductor	SHIELD		JACKET	
	Equivalent AWG	Strand Construction	Nominal Wall Thickness	Nominal Diameter		AWG of Shield	Nominal Diameter Over Shield	Nominal Wall Thickness	Nominal OD
1	38	17/50	.005	.015	.015	44	.024	.010	.044
1	38	7/46	.005	.015	.015	44	.024	.010	.044
1	36	26/50	.005	.016	.016	44	.025	.010	.045
1	36	7/44	.005	.016	.016	44	.025	.010	.045
1	34	41/50	.005	.017	.017	44	.026	.010	.046
1	34	10/44	.005	.017	.017	44	.026	.010	.046
1	34	7/42	.005	.018	.018	44	.027	.010	.047
1	32	65/50	.005	.019	.019	44	.028	.010	.048
1	32	26/46	.005	.019	.019	44	.028	.010	.048
1	32	16/44	.005	.019	.019	44	.028	.010	.048
1	32	7/40	.005	.019	.019	44	.028	.010	.048
1	30	41/46	.005	.022	.022	44	.031	.010	.051
1	30	25/44	.005	.022	.022	44	.031	.010	.051
1	30	11/40	.005	.022	.022	44	.031	.010	.051
1	30	7/38	.005	.022	.022	44	.031	.010	.051
2	38	17/50	.005	.015	.029	44	.038	.010	.058
2	38	7/46	.005	.015	.029	44	.038	.010	.058
2	36	26/50	.005	.016	.031	44	.040	.010	.060
2	36	7/44	.005	.016	.031	44	.040	.010	.060
2	34	41/50	.005	.017	.033	44	.042	.010	.062
2	34	10/44	.005	.017	.033	44	.042	.010	.062
2	34	7/42	.005	.018	.035	44	.044	.010	.064
2	32	65/50	.005	.019	.037	44	.046	.010	.066
2	32	26/46	.005	.019	.037	44	.046	.010	.066
2	32	16/44	.005	.019	.037	44	.046	.010	.066
2	32	7/40	.005	.019	.037	44	.046	.010	.066
2	30	41/46	.005	.022	.043	44	.052	.010	.072
2	30	25/44	.005	.022	.043	44	.052	.010	.072
2	30	11/40	.005	.022	.043	44	.052	.010	.072
2	30	7/38	.005	.022	.043	44	.052	.010	.072
3	38	17/50	.005	.015	.032	44	.041	.010	.061
3	38	7/46	.005	.015	.032	44	.041	.010	.061
3	36	26/50	.005	.016	.034	44	.043	.010	.063
3	36	7/44	.005	.016	.034	44	.043	.010	.063
3	34	41/50	.005	.017	.037	44	.046	.010	.066

Our standard colors for primary and overall jackets include: white, black, red, green, yellow, blue, brown, orange, gray and violet. Custom color and/or exact color match available; please contact our design team for your specific requirement.

All measurements are in inches unless otherwise stated.

[www.newenglandwire.com](http://www.newenglandwire.com)  
Tel: 603.838.6624

# Ultra Flexible Single & Multiconductor FEP & Silicone Rubber Insulated Cables, *continued*

Number of Conductors	SINGLE CONDUCTOR DATA				Nominal Diameter Over Cabled Conductor	SHIELD		JACKET	
	Equivalent AWG	Strand Construction	Nominal Wall Thickness	Nominal Diameter		AWG of Shield	Nominal Diameter Over Shield	Nominal Wall Thickness	Nominal OD
3	34	10/44	.005	.017	.037	44	.046	.010	.066
3	34	7/42	.005	.018	.039	44	.048	.010	.068
3	32	65/50	.005	.019	.041	44	.050	.010	.070
3	32	26/46	.005	.019	.041	44	.050	.010	.070
3	32	16/44	.005	.019	.041	44	.050	.010	.070
3	32	7/40	.005	.019	.041	44	.050	.010	.070
3	30	41/46	.005	.022	.047	44	.056	.010	.076
3	30	25/44	.005	.022	.047	44	.056	.010	.076
3	30	11/40	.005	.022	.047	44	.056	.010	.076
3	30	7/38	.005	.022	.047	44	.056	.010	.076
4	38	17/50	.005	.015	.036	44	.045	.010	.065
4	38	7/46	.005	.015	.036	44	.045	.010	.065
4	36	26/50	.005	.016	.039	44	.048	.010	.068
4	36	7/44	.005	.016	.039	44	.048	.010	.068
4	34	41/50	.005	.017	.041	44	.050	.010	.070
4	34	10/44	.005	.017	.041	44	.050	.010	.070
4	34	7/42	.005	.018	.043	44	.052	.010	.072
4	32	65/50	.005	.019	.046	44	.055	.010	.075
4	32	26/46	.005	.019	.046	44	.055	.010	.075
4	32	16/44	.005	.019	.046	44	.055	.010	.075
4	32	7/40	.005	.019	.046	44	.055	.010	.075
4	30	41/46	.005	.022	.053	44	.062	.010	.082
4	30	25/44	.005	.022	.053	44	.062	.010	.082
4	30	11/40	.005	.022	.053	44	.062	.010	.082
4	30	7/38	.005	.022	.053	44	.062	.010	.082
5	38	17/50	.005	.015	.041	44	.050	.010	.070
5	38	7/46	.005	.015	.041	44	.049	.010	.069
5	36	26/50	.005	.016	.043	44	.052	.010	.072
5	36	7/44	.005	.016	.043	44	.052	.010	.072
5	34	41/50	.005	.017	.046	44	.055	.010	.075
5	34	10/44	.005	.017	.046	44	.055	.010	.075
5	34	7/42	.005	.018	.049	44	.058	.010	.080
5	32	65/50	.005	.019	.051	44	.060	.010	.080
5	32	26/46	.005	.019	.051	44	.060	.010	.080
5	32	16/44	.005	.019	.051	44	.060	.010	.080
5	32	7/40	.005	.019	.051	44	.060	.010	.080
5	30	41/46	.005	.022	.059	44	.068	.010	.088
5	30	25/44	.005	.022	.059	44	.068	.010	.088
5	30	11/40	.005	.022	.059	44	.068	.010	.088
5	30	7/38	.005	.022	.059	44	.068	.010	.088

Our standard colors for primary and overall jackets include: white, black, red, green, yellow, blue, brown, orange, gray and violet. Custom color and/or exact color match available; please contact our design team for your specific requirement.

*All measurements are in inches unless otherwise stated.*



# Ultra Flexible Single & Multiconductor PVC Insulated Cables 200 Volts, 105° C

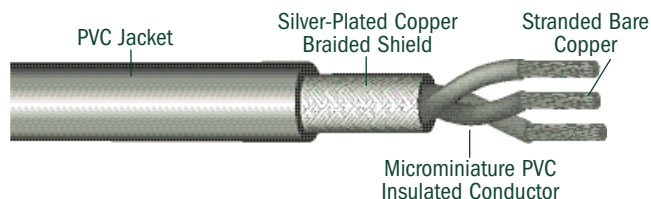

**DESCRIPTION:** Conductors are ultra flexible bare copper strands insulated with 5 mil walls of PVC. Extra flexible braided shields, jackets or both can be applied over the cabled conductors. Most of the items below are also available with tinned copper stranded conductors and tinned copper braided shields.

**USE:** Miniature relays, medical instruments and other specialized applications requiring 250 volt, 105°C ultra flexible microminiature multiconductor cables.

Number of Conductors	SINGLE CONDUCTOR DATA				Nominal Diameter Over Cabled Conductor	SHIELD		JACKET	
	Equivalent AWG	Strand Construction	Nominal Wall Thickness	Nominal Diameter		AWG of Shield	Nominal Diameter Over Shield	Nominal Wall Thickness	Nominal OD
1	38	17/50	.005	.015	.015	44	.024	.010	.044
1	38	7/46	.005	.015	.015	44	.024	.010	.044
1	36	26/50	.005	.016	.016	44	.025	.010	.045
1	36	7/44	.005	.016	.016	44	.025	.010	.045
1	34	41/50	.005	.017	.017	44	.026	.010	.046
1	34	10/44	.005	.017	.017	44	.026	.010	.046
1	34	7/42	.005	.018	.018	44	.027	.010	.047
1	32	65/50	.005	.019	.019	44	.028	.010	.048
1	32	26/46	.005	.019	.019	44	.028	.010	.048
1	32	16/44	.005	.019	.019	44	.028	.010	.048
1	32	7/40	.005	.019	.019	44	.028	.010	.048
1	30	41/46	.005	.022	.022	44	.031	.010	.051
1	30	25/44	.005	.022	.022	44	.031	.010	.051
1	30	11/40	.005	.022	.022	44	.031	.010	.051
1	30	7/38	.005	.022	.022	44	.031	.010	.051
2	38	17/50	.005	.015	.029	44	.038	.010	.058
2	38	7/46	.005	.015	.029	44	.038	.010	.058
2	36	26/50	.005	.016	.031	44	.040	.010	.060
2	36	7/44	.005	.016	.031	44	.040	.010	.060
2	34	41/50	.005	.017	.033	44	.042	.010	.062
2	34	10/44	.005	.017	.033	44	.042	.010	.062
2	34	7/42	.005	.018	.035	44	.044	.010	.064
2	32	65/50	.005	.019	.037	44	.046	.010	.066
2	32	26/46	.005	.019	.037	44	.046	.010	.066
2	32	16/44	.005	.019	.037	44	.046	.010	.066
2	32	7/40	.005	.019	.037	44	.046	.010	.066
2	30	41/46	.005	.022	.043	44	.052	.010	.072
2	30	25/44	.005	.022	.043	44	.052	.010	.072
2	30	11/40	.005	.022	.043	44	.052	.010	.072
2	30	7/38	.005	.022	.043	44	.052	.010	.072
3	38	17/50	.005	.015	.032	44	.041	.010	.061
3	38	7/46	.005	.015	.032	44	.041	.010	.061
3	36	26/50	.005	.016	.034	44	.043	.010	.063
3	36	7/44	.005	.016	.034	44	.043	.010	.063
3	34	41/50	.005	.017	.037	44	.046	.010	.066

Our standard colors for primary and overall jackets include: white, black, red, green, yellow, blue, brown, orange, gray and violet. Custom color and/or exact color match available; please contact our design team for your specific requirement.

All measurements are in inches unless otherwise stated.

www.newenglandwire.com  
Tel: 603.838.6624

# Ultra Flexible Single & Multiconductor PVC Insulated Cables, *continued*

Number of Conductors	SINGLE CONDUCTOR DATA				Nominal Diameter Over Cabled Conductor	SHIELD		JACKET	
	Equivalent AWG	Strand Construction	Nominal Wall Thickness	Nominal Diameter		AWG of Shield	Nominal Diameter Over Shield	Nominal Wall Thickness	Nominal OD
3	34	10/44	.005	.017	.037	44	.046	.010	.066
3	34	7/42	.005	.018	.039	44	.048	.010	.068
3	32	65/50	.005	.019	.041	44	.050	.010	.070
3	32	26/46	.005	.019	.041	44	.050	.010	.070
3	32	16/44	.005	.019	.041	44	.050	.010	.070
3	32	7/40	.005	.019	.041	44	.050	.010	.070
3	30	41/46	.005	.022	.047	44	.056	.010	.076
3	30	25/44	.005	.022	.047	44	.056	.010	.076
3	30	11/40	.005	.022	.047	44	.056	.010	.076
3	30	7/38	.005	.022	.047	44	.056	.010	.076
4	38	17/50	.005	.015	.036	44	.045	.010	.065
4	38	7/46	.005	.015	.036	44	.045	.010	.065
4	36	26/50	.005	.016	.039	44	.048	.010	.068
4	36	7/44	.005	.016	.039	44	.048	.010	.068
4	34	41/50	.005	.017	.041	44	.050	.010	.070
4	34	10/44	.005	.017	.041	44	.050	.010	.070
4	34	7/42	.005	.018	.043	44	.052	.010	.072
4	32	65/50	.005	.019	.046	44	.055	.010	.075
4	32	26/46	.005	.019	.046	44	.055	.010	.075
4	32	16/44	.005	.019	.046	44	.055	.010	.075
4	32	7/40	.005	.019	.046	44	.055	.010	.075
4	30	41/46	.005	.022	.053	44	.062	.010	.082
4	30	25/44	.005	.022	.053	44	.062	.010	.082
4	30	11/40	.005	.022	.053	44	.062	.010	.082
4	30	7/38	.005	.022	.053	44	.062	.010	.082
5	38	17/50	.005	.015	.041	44	.050	.010	.070
5	38	7/46	.005	.015	.041	44	.050	.010	.070
5	36	26/50	.005	.016	.043	44	.052	.010	.072
5	36	7/44	.005	.016	.043	44	.052	.010	.072
5	34	41/50	.005	.017	.046	44	.055	.010	.075
5	34	10/44	.005	.017	.046	44	.055	.010	.075
5	34	7/42	.005	.018	.049	44	.058	.010	.078
5	32	65/50	.005	.019	.051	44	.060	.010	.080
5	32	26/46	.005	.019	.051	44	.060	.010	.080
5	32	16/44	.005	.019	.051	44	.060	.010	.080
5	32	7/40	.005	.019	.051	44	.060	.010	.080
5	30	41/46	.005	.022	.060	44	.069	.010	.089
5	30	25/44	.005	.022	.060	44	.069	.010	.089
5	30	11/40	.005	.022	.060	44	.069	.010	.089
5	30	7/38	.005	.022	.060	44	.069	.010	.089

Our standard colors for primary and overall jackets include: white, black, red, green, yellow, blue, brown, orange, gray and violet. Custom color and/or exact color match available; please contact our design team for your specific requirement.

*All measurements are in inches unless otherwise stated.*



# Extra Flexible Single & Multiconductor PVC Insulated Cables 600 Volts, 105° C

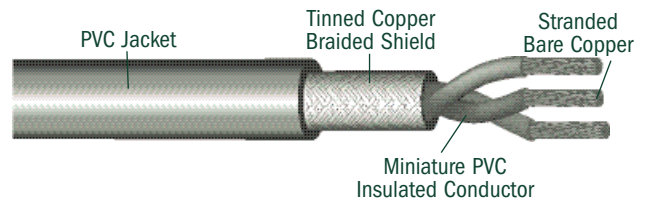

**DESCRIPTION:** Conductors are extra flexible bare copper strands insulated with 10 mil walls of PVC. Extra flexible, tinned copper braided shields, or PVC jackets or both can be applied over the cabled conductors. For special applications, spiral shield can be substituted for braided shields.

**USE:** Various medical instruments and other electronic applications requiring miniature, extra flexible multi-conductor connections. Please contact our design team for your specific application.

Number of Conductors	SINGLE CONDUCTOR DATA				Nominal Diameter Over Cabled Conductor	SHIELD		JACKET	
	Equivalent AWG	Strand Construction	Nominal Wall Thickness	Nominal Diameter		AWG of Shield	Nominal Diameter Over Shield	Nominal Wall Thickness	Nominal OD
1	34	16/46	.010	.027	.027	44	.036	.010	.056
1	34	10/44	.010	.027	.027	44	.036	.010	.056
1	34	5/40	.010	.028	.028	44	.037	.010	.057
1	32	26/46	.010	.029	.029	44	.038	.010	.058
1	32	16/44	.010	.029	.029	44	.038	.010	.058
1	32	7/40	.010	.029	.026	44	.038	.010	.058
1	30	41/46	.010	.032	.032	44	.041	.010	.061
1	30	25/44	.010	.032	.032	44	.041	.010	.061
1	30	7/38	.010	.032	.032	44	.041	.010	.061
1	29	52/46	.010	.033	.033	44	.042	.010	.062
1	28	65/46	.010	.035	.035	44	.044	.010	.064
1	28	40/44	.010	.035	.035	44	.044	.010	.064
1	28	19/40	.010	.035	.035	44	.044	.010	.064
1	26	26/40	.010	.038	.038	40	.052	.010	.072
1	26	66/44	.010	.039	.039	40	.059	.010	.079
1	26	19/38	.010	.039	.039	40	.059	.010	.073
1	24	3x35/44	.010	.045	.045	40	.059	.010	.079
1	24	42/40	.010	.043	.043	40	.057	.010	.077
1	24	19/36	.010	.044	.044	40	.058	.010	.078
1	23	3x50/44	.010	.050	.050	40	.064	.010	.084
1	22	66/40	.010	.049	.049	40	.063	.010	.083
1	22	26/36	.010	.049	.049	40	.063	.010	.083
1	20	7x37/44	.010	.060	.060	40	.074	.010	.094
1	20	7x15/40	.010	.059	.059	40	.073	.010	.093
1	20	42/36	.010	.057	.057	40	.071	.010	.091
1	18	7x59/44	.010	.070	.070	40	.084	.010	.104
1	18	7x24/40	.010	.070	.070	40	.084	.010	.104
2	34	16/46	.010	.027	.053	44	.062	.010	.082
2	34	10/44	.010	.027	.053	44	.062	.010	.082
2	34	5/40	.010	.028	.055	44	.064	.010	.084
2	32	26/46	.010	.029	.057	44	.066	.010	.086
2	32	16/44	.010	.029	.057	44	.066	.010	.086
2	32	7/40	.010	.029	.057	44	.066	.010	.086
2	30	41/46	.010	.032	.063	44	.072	.010	.092
2	30	25/44	.010	.032	.063	44	.072	.010	.092
2	30	7/38	.010	.032	.063	44	.072	.010	.092
2	29	52/46	.010	.033	.065	44	.074	.010	.094
2	28	65/46	.010	.035	.069	40	.083	.010	.103
2	28	40/44	.010	.035	.069	40	.083	.010	.103

Our standard colors for primary and overall jackets include: white, black, red, green, yellow, blue, brown, orange, gray and violet. Custom color and/or exact color match available; please contact our design team for your specific requirement.

All measurements are in inches unless otherwise stated.

[www.newenglandwire.com](http://www.newenglandwire.com)  
Tel: 603.838.6624

# Extra Flexible Single & Multiconductor PVC Insulated Cables, *continued*

Number of Conductors	SINGLE CONDUCTOR DATA				Nominal Diameter Over Cabled Conductor	SHIELD		JACKET	
	Equivalent AWG	Strand Construction	Nominal Wall Thickness	Nominal Diameter		AWG of Shield	Nominal Diameter Over Shield	Nominal Wall Thickness	Nominal OD
2	28	19/40	.010	.035	.069	40	.083	.010	.103
2	26	26/40	.010	.038	.074	40	.088	.010	.108
2	26	66/44	.010	.039	.076	40	.090	.010	.110
2	26	19/38	.010	.039	.076	40	.090	.010	.110
2	24	3x35/44	.010	.045	.088	40	.102	.015	.132
2	24	42/40	.010	.043	.084	40	.098	.015	.128
2	24	19/36	.010	.044	.086	40	.100	.015	.130
2	23	3x50/44	.010	.050	.098	36	.121	.015	.151
2	22	66/40	.010	.049	.096	36	.119	.015	.149
2	22	26/36	.010	.049	.096	36	.119	.015	.149
2	20	7x37/44	.010	.060	.118	36	.141	.015	.171
2	20	7x15/40	.010	.059	.116	36	.139	.015	.169
2	20	42/36	.010	.057	.112	36	.135	.015	.165
2	18	7x59/44	.010	.070	.137	36	.160	.020	.200
2	18	7x24/40	.010	.070	.137	36	.160	.020	.200
3	34	16/46	.010	.027	.058	44	.067	.010	.087
3	34	10/44	.010	.027	.058	44	.067	.010	.087
3	34	5/40	.010	.028	.060	44	.069	.010	.089
3	32	26/46	.010	.029	.062	44	.071	.010	.091
3	32	16/44	.010	.029	.062	44	.071	.010	.091
3	32	7/40	.010	.029	.062	44	.071	.010	.091
3	30	41/46	.010	.032	.069	44	.078	.010	.098
3	30	25/44	.010	.032	.069	44	.078	.010	.098
3	30	7/38	.010	.032	.069	44	.078	.010	.098
3	29	52/46	.010	.033	.071	40	.085	.010	.105
3	28	65/46	.010	.035	.075	40	.089	.010	.109
3	28	40/44	.010	.035	.075	40	.089	.010	.109
3	28	19/40	.010	.035	.075	40	.089	.010	.109
3	26	26/40	.010	.038	.082	40	.096	.010	.116
3	26	66/44	.010	.039	.084	40	.098	.010	.118
3	26	19/38	.010	.039	.084	40	.098	.010	.118
3	24	3x35/44	.010	.045	.097	36	.120	.015	.150
3	24	42/40	.010	.043	.092	36	.115	.015	.145
3	24	19/36	.010	.044	.095	36	.118	.015	.148
3	23	3x50/44	.010	.050	.108	36	.131	.015	.161
3	22	66/40	.010	.049	.105	36	.128	.015	.158
3	22	26/36	.010	.049	.105	36	.128	.015	.158
3	20	7x37/44	.010	.060	.129	36	.152	.020	.192
3	20	7x15/40	.010	.059	.127	36	.150	.020	.190
3	20	42/36	.010	.057	.123	36	.146	.015	.176
3	18	7x59/44	.010	.070	.151	36	.174	.020	.214
3	18	7x24/40	.010	.070	.151	36	.174	.020	.214
4	34	16/46	.010	.027	.065	44	.074	.010	.094
4	34	10/44	.010	.027	.065	44	.074	.010	.094
4	34	5/40	.010	.028	.067	44	.076	.010	.096
4	32	26/46	.010	.029	.070	44	.079	.010	.099
4	32	16/44	.010	.029	.070	44	.079	.010	.099
4	32	7/40	.010	.029	.070	44	.079	.010	.099

Our standard colors for primary and overall jackets include: white, black, red, green, yellow, blue, brown, orange, gray and violet. Custom color and/or exact color match available; please contact our design team for your specific requirement.

All measurements are in inches unless otherwise stated.





# Extra Flexible Single & Multiconductor PVC Insulated Cables, *continued*

Number of Conductors	SINGLE CONDUCTOR DATA				Nominal Diameter Over Cabled Conductor	SHIELD		JACKET	
	Equivalent AWG	Strand Construction	Nominal Wall Thickness	Nominal Diameter		AWG of Shield	Nominal Diameter Over Shield	Nominal Wall Thickness	Nominal OD
4	30	41/46	.010	.032	.077	44	.086	.010	.106
4	30	25/44	.010	.032	.077	44	.086	.010	.106
4	30	7/38	.010	.032	.077	44	.086	.010	.106
4	29	52/46	.010	.033	.080	40	.094	.010	.114
4	28	65/46	.010	.035	.084	40	.098	.010	.118
4	28	40/44	.010	.035	.084	40	.098	.010	.118
4	28	19/40	.010	.035	.084	40	.098	.010	.118
4	26	26/40	.010	.038	.092	40	.106	.010	.126
4	26	66/44	.010	.039	.094	40	.108	.010	.128
4	26	19/38	.010	.039	.094	40	.108	.010	.128
4	24	3x35/44	.010	.045	.108	36	.131	.010	.151
4	24	42/40	.010	.043	.104	36	.127	.010	.147
4	24	19/36	.010	.044	.106	36	.129	.010	.149
4	23	3x50/44	.010	.050	.121	36	.144	.010	.164
4	22	66/40	.010	.049	.118	36	.141	.010	.161
4	22	26/36	.010	.049	.118	36	.141	.010	.161
4	20	7x37/44	.010	.060	.145	36	.168	.010	.188
4	20	7x15/40	.010	.059	.142	36	.165	.010	.185
4	18	42/36	.010	.057	.137	36	.160	.010	.180
4	18	7x59/44	.010	.070	.169	36	.192	.010	.212
4	18	7x24/40	.010	.070	.169	36	.192	.010	.212
5	34	16/46	.010	.027	.073	44	.082	.010	.102
5	34	10/44	.010	.027	.073	44	.082	.010	.102
5	32	5/40	.010	.028	.076	44	.085	.010	.105
5	32	26/46	.010	.029	.079	44	.088	.010	.108
5	32	16/44	.010	.029	.079	44	.088	.010	.108
5	30	7/40	.010	.029	.079	44	.088	.010	.108
5	30	41/46	.010	.032	.087	40	.096	.010	.116
5	30	25/44	.010	.032	.087	40	.096	.010	.116
5	29	7/38	.010	.032	.087	40	.096	.010	.116
5	28	52/46	.010	.033	.089	40	.103	.010	.123
5	28	65/46	.010	.035	.095	40	.109	.010	.129
5	28	40/44	.010	.035	.095	40	.109	.010	.129
5	26	19/40	.010	.035	.095	40	.109	.010	.129
5	26	26/40	.010	.038	.103	40	.117	.010	.137
5	26	66/44	.010	.039	.106	40	.120	.010	.140
5	24	19/38	.010	.039	.106	40	.120	.010	.140
5	24	3x35/44	.010	.045	.122	36	.145	.010	.165
5	24	42/40	.010	.043	.117	36	.140	.010	.160
5	22	19/36	.010	.044	.119	36	.142	.010	.162
5	22	3x50/44	.010	.050	.136	36	.159	.010	.179
5	22	66/40	.010	.049	.133	36	.156	.010	.176
5	20	26/36	.010	.049	.133	36	.156	.010	.176
5	20	7x37/44	.010	.060	.163	36	.186	.010	.206
5	20	7x15/40	.010	.059	.160	36	.183	.010	.203
5	18	42/36	.010	.057	.154	36	.177	.010	.197
5	18	7x59/44	.010	.070	.190	36	.213	.010	.233
5	18	7x24/40	.010	.070	.190	36	.213	.010	.233

Our standard colors for primary and overall jackets include: white, black, red, green, yellow, blue, brown, orange, gray and violet. Custom color and/or exact color match available; please contact our design team for your specific requirement.

*All measurements are in inches unless otherwise stated.*

[www.newenglandwire.com](http://www.newenglandwire.com)

Tel: 603.838.6624

# Single & Multiconductor PVC Insulated Cables 600 Volts, 105° C

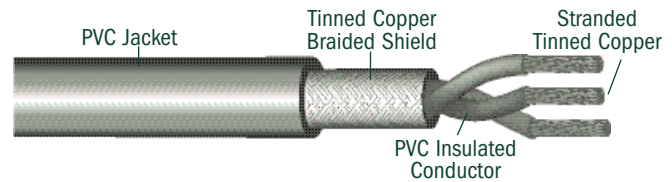

**DESCRIPTION:** Tin-plated copper conductors insulated with 10 mil walls PVC. Braided shields, jackets or both can be applied over the cabled conductors. For special applications, spiral shields can be substituted for braided shields. Primary and final jacket color determined by customer.

**USE:** Intercoms, radio equipment, computers, sensors, monitoring equipment and other electronic apparatus requiring 600 volt, 105°C multiconductor cables for interconnections. Please contact our design team for your specific application requirements.

Number of Conductors	SINGLE CONDUCTOR DATA				Nominal Diameter Over Cabled Conductor	SHIELD		JACKET	
	Equivalent AWG	Strand Construction	Nominal Wall Thickness	Nominal Diameter		AWG of Shield	Nominal Diameter Over Shield	Nominal Wall Thickness	Nominal OD
1	36	7/44	.010	.026	.026	40	.040	.010	.060
1	34	10/44	.010	.027	.027	40	.041	.010	.061
1	34	7/42	.010	.028	.028	40	.042	.010	.062
1	32	7/40	.010	.029	.029	40	.043	.010	.063
1	32	19/44	.010	.030	.026	40	.044	.010	.064
1	30	11/40	.010	.032	.032	40	.046	.010	.066
1	30	7/38	.010	.032	.032	40	.046	.010	.066
1	28	19/40	.010	.035	.035	40	.049	.010	.069
1	28	7/36	.010	.035	.035	40	.049	.010	.069
1	26	26/40	.010	.038	.038	40	.052	.010	.072
1	26	19/38	.010	.039	.039	40	.053	.010	.073
1	24	42/40	.010	.043	.043	40	.057	.010	.077
1	24	19/36	.010	.044	.044	40	.058	.010	.078
2	36	7/44	.010	.026	.051	40	.065	.010	.085
2	34	10/44	.010	.027	.053	40	.067	.010	.087
2	34	7/42	.010	.028	.055	40	.069	.010	.089
2	32	7/40	.010	.029	.057	40	.071	.010	.091
2	32	19/44	.010	.030	.059	40	.073	.010	.093
2	30	11/40	.010	.032	.063	40	.077	.010	.097
2	30	7/38	.010	.032	.063	40	.077	.010	.097
2	28	19/40	.010	.035	.069	40	.083	.010	.103
2	28	7/36	.010	.035	.069	40	.083	.010	.103
2	26	26/40	.010	.038	.074	40	.088	.010	.108
2	26	19/38	.010	.039	.076	40	.090	.010	.110
2	24	42/40	.010	.043	.084	40	.098	.010	.118
2	24	19/36	.010	.044	.086	40	.100	.010	.120
3	36	7/44	.010	.026	.056	40	.070	.010	.090
3	34	10/44	.010	.027	.058	40	.072	.010	.092
3	34	7/42	.010	.028	.060	40	.074	.010	.094
3	32	7/40	.010	.029	.062	40	.076	.010	.096
3	32	19/44	.010	.030	.065	40	.079	.010	.099
3	30	11/40	.010	.032	.069	40	.083	.010	.103
3	30	7/38	.010	.032	.069	40	.083	.010	.103
3	28	19/40	.010	.035	.075	40	.089	.010	.109
3	28	7/36	.010	.035	.075	40	.089	.010	.109
3	26	26/40	.010	.038	.082	40	.096	.010	.116
3	26	19/38	.010	.039	.084	40	.098	.010	.118
3	24	42/40	.010	.043	.092	40	.106	.015	.136
3	24	19/36	.010	.044	.095	40	.109	.015	.139

All measurements are in inches unless otherwise stated.



NEW ENGLAND WIRE TECHNOLOGIES  
Innovate. Create. Accelerate.

# Single and Multiconductor Cables, PVC Insulated, *continued*

Number of Conductors	SINGLE CONDUCTOR DATA				Nominal Diameter Over Cabled Conductor	SHIELD		JACKET	
	Equivalent AWG	Strand Construction	Nominal Wall Thickness	Nominal Diameter		AWG of Shield	Nominal Diameter Over Shield	Nominal Wall Thickness	Nominal OD
4	36	7/44	.010	.026	.063	40	.077	.010	.097
4	34	10/44	.010	.027	.067	40	.079	.010	.099
4	34	7/42	.010	.028	.065	40	.081	.010	.101
4	32	7/40	.010	.029	.070	40	.084	.010	.104
4	32	19/44	.010	.030	.072	40	.086	.010	.106
4	30	11/40	.010	.032	.077	40	.091	.010	.111
4	30	7/38	.010	.032	.077	40	.091	.010	.111
4	28	19/40	.010	.035	.084	40	.098	.010	.118
4	28	7/36	.010	.035	.084	40	.098	.010	.118
4	26	26/40	.010	.038	.092	40	.106	.015	.136
4	26	19/38	.010	.039	.094	40	.108	.015	.128
4	24	42/40	.010	.043	.104	40	.118	.015	.148
4	24	19/36	.010	.044	.106	40	.120	.015	.150
5	36	7/44	.010	.026	.070	40	.084	.010	.104
5	34	10/44	.010	.027	.073	40	.090	.010	.107
5	34	7/42	.010	.028	.076	40	.087	.010	.110
5	32	7/40	.010	.029	.079	40	.093	.010	.113
5	32	19/44	.010	.030	.081	40	.095	.010	.115
5	30	11/40	.010	.032	.087	40	.101	.015	.131
5	30	7/38	.010	.032	.087	40	.101	.015	.131
5	28	19/40	.010	.035	.095	40	.109	.015	.139
5	28	7/36	.010	.035	.095	40	.109	.015	.139
5	26	26/40	.010	.038	.103	40	.117	.015	.147
5	26	19/38	.010	.038	.106	40	.120	.015	.150
5	24	42/40	.010	.043	.117	40	.131	.015	.161
5	24	19/36	.010	.044	.119	40	.133	.015	.163

Our standard colors for primary and overall jackets include: white, black, red, green, yellow, blue, brown, orange, gray and violet. Custom color and/or exact color match available; please contact our design team for your specific requirement.

*All measurements are in inches unless otherwise stated.*

[www.newenglandwire.com](http://www.newenglandwire.com)  
Tel: 603.838.6624

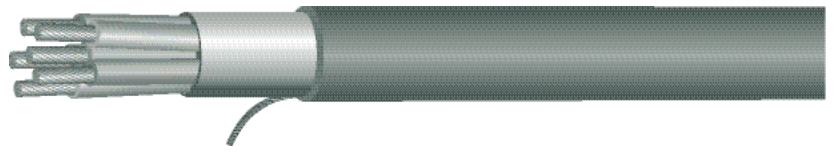

Our NEWguard™ cables are custom designed for the most challenging and demanding environments. In extreme conditions, cable becomes a critical link that supplies low voltage power, control and data signals. NEWguard™ cable remains flexible while meeting environmental challenges such as extreme temperature, mechanical abuse, presence of strong chemicals, exposure to oils, dust, wind, salt water spray and vibration.

NEWguard™ range of cables is designed around specially formulated grades of jacketing materials for challenging environments. We offer the following options:

- NEWguard™ 1** Special high molecular weight PVC that is chemical, oil and flame resistant.
- NEWguard™ 2** Polyurethane material that is abuse resistant, puncture and abrasion resistant, flame retardant, chemical resistant, oil resistant and hydrolysis resistant.
- NEWguard™ 3** Polyethylene black jacketing material that is sunlight resistant, outdoor resistant.
- NEWguard™ 4** Thermoplastic Elastomer material that is suitable for very cold and hot temperatures.
- NEWguard™ 5** Fluorocopolymer material that is suitable for very high temperature, and inert to every common chemical and oil.

In some cases, we can also recommend our proprietary NEWtuf™ line of cables with reinforced silicone rubber jackets or other crosslinked jacketing materials. Please contact our design team for cables manufactured to meet your specific needs.

New England Wire Technologies has sophisticated capabilities in conductor manufacturing, high technology insulation materials, and a variety of shielding options all designed for your specific requirements.

## CONDUCTOR OPTIONS

- Conductors of high strength, high conductivity metal alloys. 42 AWG to 4/0 AWG.
- Conductors of Electrolytic tough pitch, oxygen free, tinned and silver plated copper. 42 AWG to 4/0 AWG.
- Ultra fine stranding, rope lay constructions for super flexibility. Each strand 30-50 AWG.
- High performance, small diameter insulations systems. Fluoropolymers, Polyolefins, PVC.
- Strength members.
- Constructions designed for continuous flexing applications. The flexing can be rolling flex, bending flex or torsional flex application.

## REGULATORY APPROVALS

We offer a broad range of UL and CSA approvals for 300 and 600 volt cables. For new applications, we can also obtain a special regulatory approval.

Note: Our full line of NEWguard™ products is expected to be available by July 2006. Please call our design team for availability.



NEWguard™ cables are designed for a diverse range of low voltage power, control and data signal applications in challenging environments. We can custom design small diameter, very flexible cables for high flex life and electromagnetic noise immunity.



**APPLICATIONS OF NEWguard™ CABLES:**

- Chemical, petrochemical plants
- Wood, paper and pulp plants
- Automotive factories
- Steel, glass and metal foundries
- Mining industry
- Military ground support systems
- Arctic environments
- Down-hole pump applications
- Conveyor lines
- Mass transit systems
- Food and beverage plants
- CNC machining centers
- Packaging machinery

- Oil fields and geophysical exploration equipment
- Earth moving machinery with vibration concerns
- Clean room environment
- Satellite communications
- Inter-building communications
- Land irrigation systems
- Outdoor security systems
- Outdoor scoreboard and displays
- Pipeline sensor controls.

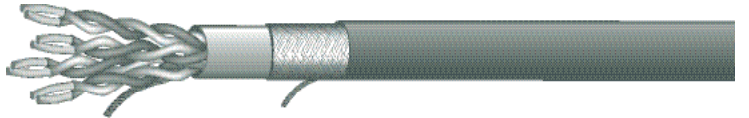

**PROPERTY COMPARISON, NEWguard™ JACKETING OPTIONS:**

PROPERTY	NEWguard™1	NEWguard™2	NEWguard™3	NEWguard™4	NEWguard™5*
Temperature, ° C	-20° to +80°	-20° to +80°	-20° to +80°	-40° to +105°	-60° to +150°
Jacket hardness, Shore	80-82 A	86-88 A	82 C	82 C	75 D
Abrasion resistance	Good	Very Good	Very Good	Good	Excellent
Cut through resistance	Fair	Very Good	Good	Good	Excellent
Flame resistance	Good	Good	Poor	Good	Excellent
Sunlight resistance	Good	Good	Very Good	Good	Excellent
Oil resistance**	Good	Good	Good	Good	Excellent
Chemical resistance**	Good	Very Good	Very Good	Good	Excellent
Salt water resistance**	Very Good	Good	Very Good	Very Good	Excellent
Dusty environment	Good	Very Good	Very Good	Good	Excellent
Vibration	Special designs for vibration resistance. Also special installation techniques.				
Flexibility	Very Good	Very Good	Fair	Good	Fair
Continuous flexing	Yes, custom design	Yes, custom design	No	Yes, custom design	No
Electrical noise immunity	Custom designs for high levels of immunity.				
Cable OD	Custom designs for small diameters with small conductors, insulations.				

\* NEWguard™ 5 rated - 80 to 200°C also available.  
 \*\* Chemical resistance data are for brief exposures (like splashes) to common industrial cleaning chemicals, oils, mild acids and mild bases. For more severe chemical resistance needs, please contact our design engineering team.



# MEDICAL COMPOSITE CABLES, *continued*

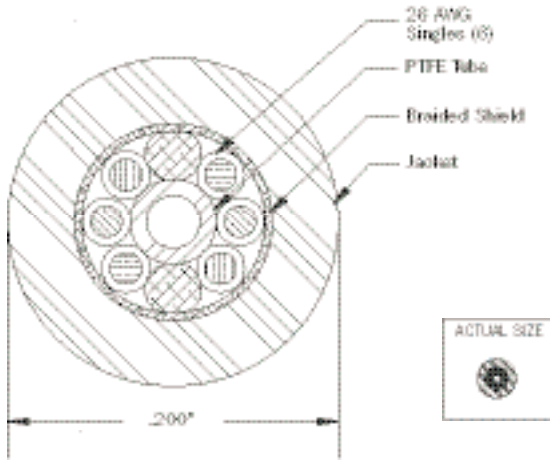

**6 Conductor Cable:** 6 - 26 AWG singles with PFA insulation cabled with fillers around vent tube, shielded and jacketed with silicone rubber 0.200" O.D.

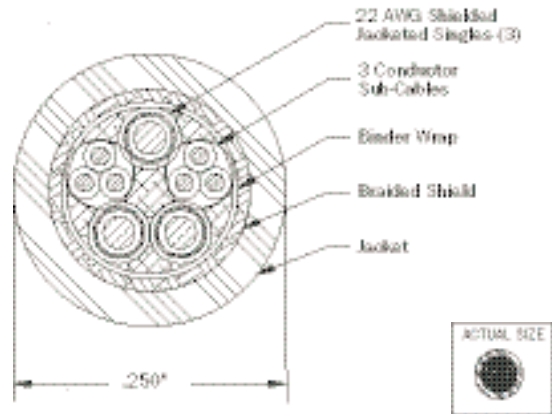

**9 Conductor Cable:** 3 - 22 AWG tinned copper, shielded and jacketed singles and 2 - 28 AWG Newaloy 61 sub-cables cabled around a core then taped, shielded and jacketed with silicone rubber to 0.250" O.D.

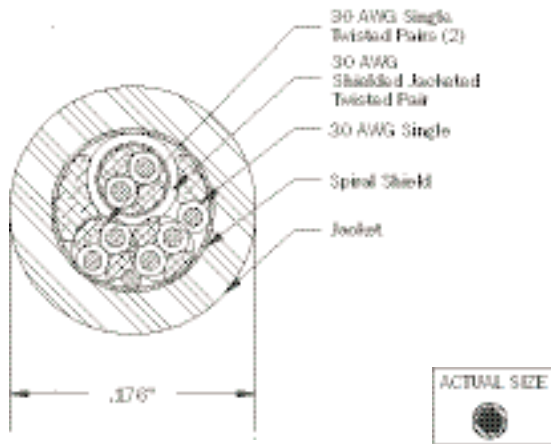

**22 Conductor Cable:** 2 - 30 AWG NEWaloy 61 twisted pairs, a 30 AWG shielded, jacketed twisted pair and a 30 AWG Newaloy 61 single cabled with Aramid fillers and drain wire then spiral shielded and jacketed with polyurethane to 0.176" O.D.

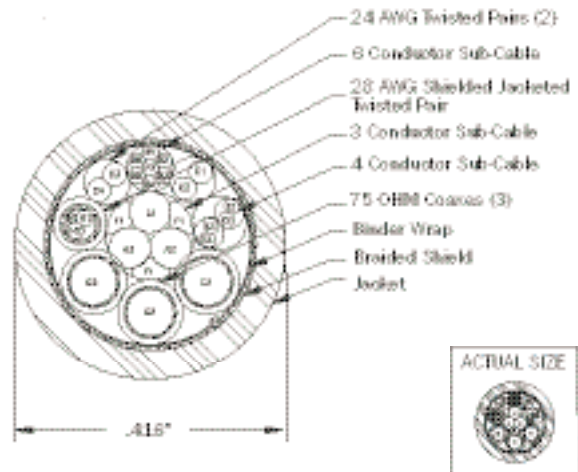

**22 Conductor Cable:** 6 conductor sub-cable, 2 - 24 AWG twisted pairs, 4 conductor sub-cable, 28 AWG shielded and jacketed twisted pair, and 3 - 75 OHM coaxes all cabled around 3 conductor 18 AWG sub-cable then taped, shielded and jacketed with polyurethane to 0.416" O.D.

# Ultra Flexible Single & Multiconductor PFA & Silicone Rubber Insulated Cables 250 Volts, 150 ° C

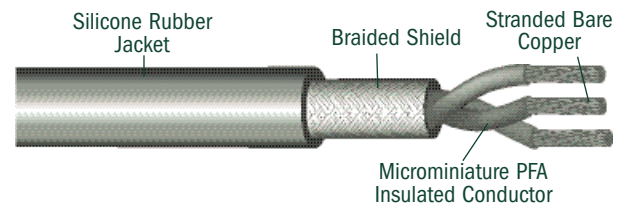

**DESCRIPTION:** Conductors are ultra flexible bare copper strands insulated with 5 mil walls of color coded PFA. Extra flexible braided shields are optional over the cabled conductors prior to jacketing with silicone rubber. Although shown with bare copper conductors and shields, most constructions are available with tinned copper conductors and shields.

**USE:** Used primarily for miniature relays, medical instruments and other specialized applications requiring ultra flexible microminiature multiconductor cables. Please contact our design team to confirm voltage and temperature ratings to match your specific application.

Number of Conductors	SINGLE CONDUCTOR DATA				Nominal Diameter Over Cabled Conductor	SHIELD		JACKET	
	AWG Size	Strand Construction	Nominal Wall Thickness	Nominal Diameter		AWG of Shield	Nominal Diameter Over Shield	Nominal Wall Thickness	Nominal OD
1	38	17/50	.005	.015	.015	44	.024	.010	.044
1	38	7/46	.005	.015	.015	44	.024	.010	.044
1	36	26/50	.005	.016	.016	44	.025	.010	.045
1	36	7/44	.005	.016	.016	44	.025	.010	.045
1	34	41/50	.005	.017	.017	44	.026	.010	.046
1	34	10/44	.005	.017	.017	44	.026	.010	.046
1	34	7/42	.005	.018	.018	44	.027	.010	.047
1	32	65/50	.005	.019	.019	44	.028	.010	.048
1	32	26/46	.005	.019	.019	44	.028	.010	.048
1	32	16/44	.005	.019	.019	44	.028	.010	.048
1	32	7/40	.005	.019	.019	44	.028	.010	.048
1	30	41/46	.005	.022	.022	44	.031	.010	.051
1	30	25/44	.005	.022	.022	44	.031	.010	.051
1	30	11/40	.005	.022	.022	44	.031	.010	.051
1	30	7/38	.005	.022	.022	44	.031	.010	.051
2	38	17/50	.005	.015	.029	44	.038	.010	.058
2	38	7/46	.005	.015	.029	44	.038	.010	.058
2	36	26/50	.005	.016	.031	44	.040	.010	.060
2	36	7/44	.005	.016	.031	44	.040	.010	.060
2	34	41/50	.005	.017	.033	44	.042	.010	.062
2	34	10/44	.005	.017	.033	44	.042	.010	.062
2	34	7/42	.005	.018	.035	44	.044	.010	.064
2	32	65/50	.005	.019	.037	44	.046	.010	.066
2	32	26/46	.005	.019	.037	44	.046	.010	.066
2	32	16/44	.005	.019	.037	44	.046	.010	.066
2	32	7/40	.005	.019	.037	44	.046	.010	.066
2	30	41/46	.005	.022	.043	44	.052	.010	.072
2	30	25/44	.005	.022	.043	44	.052	.010	.072
2	30	11/40	.005	.022	.043	44	.052	.010	.072
2	30	7/38	.005	.022	.043	44	.052	.010	.072
3	38	17/50	.005	.015	.032	44	.041	.010	.061
3	38	7/46	.005	.015	.032	44	.041	.010	.061
3	36	26/50	.005	.016	.034	44	.043	.010	.063
3	36	7/44	.005	.016	.034	44	.043	.010	.063
3	34	41/50	.005	.017	.037	44	.046	.010	.066

Our standard colors for primary and overall jackets include: white, black, red, green, yellow, blue, brown, orange, gray and violet. Custom color and/or exact color match available; please contact our design team for your specific requirement.

All measurements are in inches unless otherwise stated.

[www.newenglandwire.com](http://www.newenglandwire.com)  
Tel: 603.838.6624



# Ultra Flexible Single & Multiconductor PFA & Silicone Rubber Insulated Cables, *continued*

Number of Conductors	SINGLE CONDUCTOR DATA				Nominal Diameter Over Cabled Conductor	SHIELD		JACKET	
	Equivalent AWG	Strand Construction	Nominal Wall Thickness	Nominal Diameter		AWG of Shield	Nominal Diameter Over Shield	Nominal Wall Thickness	Nominal OD
3	34	10/44	.005	.017	.037	44	.046	.010	.066
3	34	7/42	.005	.018	.039	44	.048	.010	.068
3	32	65/50	.005	.019	.041	44	.050	.010	.070
3	32	26/46	.005	.019	.041	44	.050	.010	.070
3	32	16/44	.005	.019	.041	44	.050	.010	.070
3	32	7/40	.005	.019	.041	44	.050	.010	.070
3	30	41/46	.005	.022	.047	44	.056	.010	.076
3	30	25/44	.005	.022	.047	44	.056	.010	.076
3	30	11/40	.005	.022	.047	44	.056	.010	.076
3	30	7/38	.005	.022	.047	44	.056	.010	.076
4	38	17/50	.005	.015	.032	44	.041	.010	.061
4	38	7/46	.005	.015	.036	44	.045	.010	.065
4	36	26/50	.005	.016	.039	44	.048	.010	.068
4	36	7/44	.005	.016	.039	44	.048	.010	.068
4	34	41/50	.005	.017	.041	44	.050	.010	.070
4	34	10/44	.005	.017	.041	44	.050	.010	.070
4	34	7/42	.005	.018	.043	44	.052	.010	.072
4	32	65/50	.005	.019	.046	44	.055	.010	.075
4	32	26/46	.005	.019	.046	44	.055	.010	.075
4	32	16/44	.005	.019	.046	44	.055	.010	.075
4	32	7/40	.005	.019	.046	44	.055	.010	.075
4	30	41/46	.005	.022	.053	44	.062	.010	.082
4	30	25/44	.005	.022	.053	44	.062	.010	.082
4	30	11/40	.005	.022	.053	44	.062	.010	.082
4	30	7/38	.005	.022	.053	44	.062	.010	.082
5	38	17/50	.005	.015	.041	44	.050	.010	.070
5	38	7/46	.005	.015	.041	44	.049	.010	.069
5	36	26/50	.005	.016	.043	44	.052	.010	.072
5	36	7/44	.005	.016	.043	44	.052	.010	.072
5	34	41/50	.005	.017	.046	44	.055	.010	.075
5	34	10/44	.005	.017	.046	44	.055	.010	.075
5	34	7/42	.005	.018	.049	44	.058	.010	.078
5	32	65/50	.005	.019	.051	44	.060	.010	.080
5	32	26/46	.005	.019	.051	44	.060	.010	.080
5	32	16/44	.005	.019	.051	44	.060	.010	.080
5	32	7/40	.005	.019	.051	44	.060	.010	.080
5	30	41/46	.005	.022	.059	44	.068	.010	.088
5	30	25/44	.005	.022	.059	44	.068	.010	.088
5	30	11/40	.005	.022	.059	44	.068	.010	.088
5	30	7/38	.005	.022	.059	44	.068	.010	.088

Our standard colors for primary and overall jackets include: white, black, red, green, yellow, blue, brown, orange, gray and violet. Custom color and/or exact color match available; please contact our design team for your specific requirement.

*All measurements are in inches unless otherwise stated.*



# Ultra Flexible Single & Multiconductor FEP & Polyurethane Insulated Cables, *continued*

Number of Conductors	SINGLE CONDUCTOR DATA				Nominal Diameter Over Cabled Conductor	SHIELD		JACKET	
	Equivalent AWG	Strand Construction	Nominal Wall Thickness	Nominal Diameter		AWG of Shield	Nominal Diameter Over Shield	Nominal Wall Thickness	Nominal OD
3	34	10/44	.005	.017	.037	44	.046	.010	.066
3	34	7/42	.005	.018	.039	44	.048	.010	.068
3	32	65/50	.005	.019	.041	44	.050	.010	.070
3	32	26/46	.005	.019	.041	44	.050	.010	.070
3	32	16/44	.005	.019	.041	44	.050	.010	.070
3	32	7/40	.005	.019	.041	44	.050	.010	.070
3	30	41/46	.005	.022	.047	44	.056	.010	.076
3	30	25/44	.005	.022	.047	44	.056	.010	.076
3	30	11/40	.005	.022	.047	44	.056	.010	.076
3	30	7/38	.005	.022	.047	44	.056	.010	.076
4	38	17/50	.005	.015	.032	44	.041	.010	.061
4	38	7/46	.005	.015	.036	44	.045	.010	.065
4	36	26/50	.005	.016	.039	44	.048	.010	.068
4	36	7/44	.005	.016	.039	44	.048	.010	.068
4	34	41/50	.005	.017	.041	44	.050	.010	.070
4	34	10/44	.005	.017	.041	44	.050	.010	.070
4	34	7/42	.005	.018	.043	44	.052	.010	.072
4	32	65/50	.005	.019	.046	44	.055	.010	.075
4	32	26/46	.005	.019	.046	44	.055	.010	.075
4	32	16/44	.005	.019	.046	44	.055	.010	.075
4	32	7/40	.005	.019	.046	44	.055	.010	.075
4	30	41/46	.005	.022	.053	44	.062	.010	.082
4	30	25/44	.005	.022	.053	44	.062	.010	.082
4	30	11/40	.005	.022	.053	44	.062	.010	.082
4	30	7/38	.005	.022	.053	44	.062	.010	.082
5	38	17/50	.005	.015	.041	44	.050	.010	.070
5	38	7/46	.005	.015	.041	44	.049	.010	.069
5	36	26/50	.005	.016	.043	44	.052	.010	.072
5	36	7/44	.005	.016	.043	44	.052	.010	.072
5	34	41/50	.005	.017	.046	44	.055	.010	.075
5	34	10/44	.005	.017	.046	44	.055	.010	.075
5	34	7/42	.005	.018	.049	44	.058	.010	.078
5	32	65/50	.005	.019	.051	44	.060	.010	.080
5	32	26/46	.005	.019	.051	44	.060	.010	.080
5	32	16/44	.005	.019	.051	44	.060	.010	.080
5	32	7/40	.005	.019	.051	44	.060	.010	.080
5	30	41/46	.005	.022	.059	44	.068	.010	.088
5	30	25/44	.005	.022	.059	44	.068	.010	.088
5	30	11/40	.005	.022	.059	44	.068	.010	.088
5	30	7/38	.005	.022	.059	44	.068	.010	.088

Our standard colors for primary and overall jackets include: white, black, red, green, yellow, blue, brown, orange, gray and violet. Custom color and/or exact color match available; please contact our design team for your specific requirement.

*All measurements are in inches unless otherwise stated.*

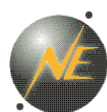

# Extra Flexible Single & Multiconductor Silicone Rubber Insulated Cables 300 Volts, 150° C

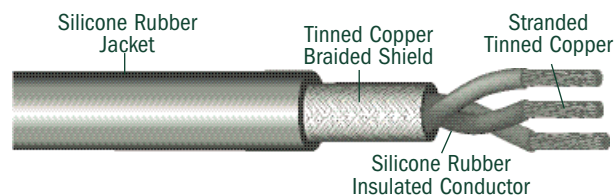

**DESCRIPTION:** Conductors are tin-plated copper strands insulated with 10 mil walls of silicone rubber. Braided shields can be applied over the cabled conductors prior to jacketing with silicone rubber. For special applications, spiral shields can be substituted for braided shields.

**USE:** For use on medical instruments where good flexibility and high temperature resistance are required. Please contact our design team for your specific requirements.

Number of Conductors	SINGLE CONDUCTOR DATA				Nominal Diameter Over Cabled Conductor	SHIELD		JACKET	
	Equivalent AWG	Strand Construction	Nominal Wall Thickness	Nominal Diameter		AWG of Shield	Nominal Diameter Over Shield	Nominal Wall Thickness	Nominal OD
1	36	7/44	.010	.026	.026	40	.040	.010	.060
1	34	7/42	.010	.028	.028	40	.042	.010	.062
1	32	19/44	.010	.030	.026	40	.044	.010	.064
1	30	7/38	.010	.032	.032	40	.046	.010	.066
1	28	7/36	.010	.035	.035	40	.049	.010	.069
1	26	19/38	.010	.039	.039	40	.053	.010	.073
1	24	19/36	.010	.044	.044	40	.058	.010	.078
2	34	10/44	.010	.027	.053	40	.067	.010	.087
2	32	7/40	.010	.029	.057	40	.071	.010	.091
2	30	11/40	.010	.032	.063	40	.077	.015	.107
2	28	19/40	.010	.035	.069	40	.083	.015	.113
2	26	26/40	.010	.038	.074	40	.088	.015	.118
2	24	42/40	.010	.043	.084	40	.098	.015	.128
3	36	7/44	.010	.026	.056	40	.070	.010	.090
3	34	7/42	.010	.028	.060	40	.074	.010	.094
3	32	19/44	.010	.029	.065	40	.079	.010	.099
3	30	7/38	.010	.032	.069	40	.083	.010	.103
3	28	7/36	.010	.035	.075	40	.089	.015	.119
3	26	19/38	.010	.039	.084	40	.098	.015	.128
3	24	19/36	.010	.044	.095	40	.109	.015	.139

Our standard colors for primary and overall jackets include: white, black, red, green, yellow, blue, brown, orange, gray and violet. Custom color and/or exact color match available; please contact our design team for your specific requirement.

All measurements are in inches unless otherwise stated.

[www.newenglandwire.com](http://www.newenglandwire.com)  
Tel: 603.838.6624

# Extra Flexible Single & Multiconductor Cable Silicone Rubber Insulated, *continued*

Number of Conductors	SINGLE CONDUCTOR DATA				Nominal Diameter Over Cabled Conductor	SHIELD		JACKET	
	Equivalent AWG	Strand Construction	Nominal Wall Thickness	Nominal Diameter		AWG of Shield	Nominal Diameter Over Shield	Nominal Wall Thickness	Nominal OD
4	36	7/44	.010	.026	.063	40	.077	.010	.097
4	34	10/44	.010	.027	.067	40	.079	.010	.099
4	34	7/42	.010	.028	.065	40	.081	.010	.101
4	32	7/40	.010	.029	.070	40	.084	.010	.104
4	32	19/44	.010	.030	.072	40	.086	.010	.106
4	30	11/40	.010	.032	.077	40	.091	.015	.121
4	30	7/38	.010	.032	.077	40	.091	.015	.121
4	28	19/40	.010	.035	.084	40	.098	.015	.128
4	28	7/36	.010	.035	.084	40	.098	.015	.128
4	26	26/40	.010	.038	.092	40	.106	.015	.136
4	26	19/38	.010	.039	.094	40	.108	.015	.138
4	24	42/40	.010	.043	.104	40	.118	.015	.148
4	24	19/36	.010	.044	.106	40	.120	.015	.150
5	36	7/44	.010	.026	.070	40	.084	.010	.104
5	34	10/44	.010	.028	.076	40	.090	.010	.110
5	34	7/42	.010	.027	.073	40	.087	.010	.107
5	32	7/40	.010	.029	.079	40	.093	.010	.113
5	32	19/44	.010	.030	.081	40	.095	.010	.115
5	30	11/40	.010	.032	.087	40	.101	.015	.131
5	30	7/38	.010	.032	.087	40	.101	.015	.131
5	28	19/40	.010	.035	.095	40	.109	.015	.139
5	28	7/36	.010	.035	.095	40	.109	.015	.139
5	26	26/40	.010	.038	.103	40	.117	.015	.147
5	26	19/38	.010	.038	.106	40	.120	.015	.150
5	24	42/40	.010	.043	.117	40	.131	.015	.161
5	24	19/36	.010	.044	.119	40	.133	.015	.163

Our standard colors for primary and overall jackets include: white, black, red, green, yellow, blue, brown, orange, gray and violet. Custom color and/or exact color match available; please contact our design team for your specific requirement.

*All measurements are in inches unless otherwise stated.*



# Ultra Flexible Single & Multiconductor FEP & Polyurethane Insulated Cables 250 Volts, 80° C

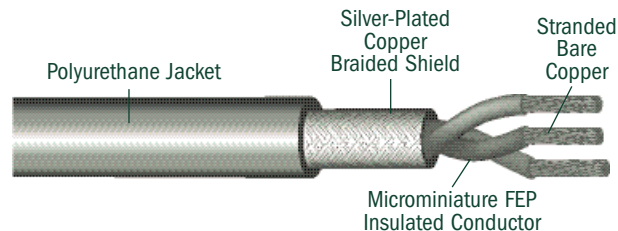

**DESCRIPTION:** Conductors are ultra flexible bare copper strands insulated with 5 mil wall of FEP. Extra flexible braided shields can be applied over the cabled conductors prior to jacketing with Polyurethane in either a high-gloss or satin finish. Most of the items below are also available with tinned copper stranded conductors and tinned copper braided shields.

**USE:** Used primarily in medical instruments and other specialized applications where ultra flexibility must be combined with the abrasion resistant properties of the Polyurethane jacket. Please contact our design team to confirm voltage and temperature ratings to match your specific application.

Number of Conductors	SINGLE CONDUCTOR DATA				Nominal Diameter Over Cabled Conductor	SHIELD		JACKET	
	Equivalent AWG	Strand Construction	Nominal Wall Thickness	Nominal Diameter		AWG of Shield	Nominal Diameter Over Shield	Nominal Wall Thickness	Nominal OD
1	38	17/50	.005	.015	.015	44	.024	.010	.044
1	38	7/46	.005	.015	.015	44	.024	.010	.044
1	36	26/50	.005	.016	.016	44	.025	.010	.045
1	36	7/44	.005	.016	.016	44	.025	.010	.045
1	34	41/50	.005	.017	.017	44	.026	.010	.046
1	34	10/44	.005	.017	.017	44	.026	.010	.046
1	34	7/42	.005	.018	.018	44	.027	.010	.047
1	32	65/50	.005	.019	.019	44	.028	.010	.048
1	32	26/46	.005	.019	.019	44	.028	.010	.048
1	32	16/44	.005	.019	.019	44	.028	.010	.048
1	32	7/40	.005	.019	.019	44	.028	.010	.048
1	30	41/46	.005	.022	.022	44	.031	.010	.051
1	30	25/44	.005	.022	.022	44	.031	.010	.051
1	30	11/40	.005	.022	.022	44	.031	.010	.051
1	30	7/38	.005	.022	.022	44	.031	.010	.051
2	38	17/50	.005	.015	.029	44	.038	.010	.058
2	38	7/46	.005	.015	.029	44	.038	.010	.058
2	36	26/50	.005	.016	.031	44	.040	.010	.060
2	36	7/44	.005	.016	.031	44	.040	.010	.060
2	34	41/50	.005	.017	.033	44	.042	.010	.062
2	34	10/44	.005	.017	.033	44	.042	.010	.062
2	34	7/42	.005	.018	.035	44	.044	.010	.064
2	32	65/50	.005	.019	.037	44	.046	.010	.066
2	32	26/46	.005	.019	.037	44	.046	.010	.066
2	32	16/44	.005	.019	.037	44	.046	.010	.066
2	32	7/40	.005	.019	.037	44	.046	.010	.066
2	30	41/46	.005	.022	.043	44	.052	.010	.072
2	30	25/44	.005	.022	.043	44	.052	.010	.072
2	30	11/40	.005	.022	.043	44	.052	.010	.072
2	30	7/38	.005	.022	.043	44	.052	.010	.072
2	38	17/50	.005	.015	.032	44	.041	.010	.061
3	38	7/46	.005	.015	.032	44	.041	.010	.061
3	36	26/50	.005	.016	.034	44	.043	.010	.063
3	36	7/44	.005	.016	.034	44	.043	.010	.063
3	34	41/50	.005	.017	.037	44	.046	.010	.066

Our standard colors for primary and overall jackets include: white, black, red, green, yellow, blue, brown, orange, gray and violet. Custom color and/or exact color match available; please contact our design team for your specific requirement.

All measurements are in inches unless otherwise stated.

www.newenglandwire.com  
Tel: 603.838.6624

# Ultra Flexible Microminiature PFA Insulated Lead Wire 150 Volt, 200°C

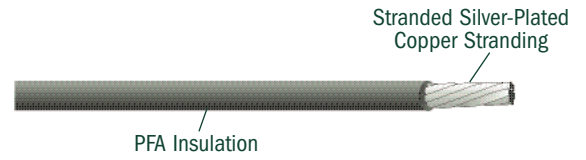

**DESCRIPTION:** Ultra flexible, microminiature stranded silver-plated copper conductor insulated with a 3.5 mil wall of clear, non-hygroscopic PFA.

**USE:** Critical physiological applications where small diameters, highly flexible and non-toxic insulated conductors are mandated. Designed for long usage in flow probes and pressure measuring instruments. Please contact our design team for your specific application.

Equivalent AWG	CONDUCTOR INFORMATION				Nominal Wall Thickness	Nominal OD
	Circular Mil Area	Number of Wires	AWG of Wire	Conductor Diameter		
42	6.9	7	50	.003	.0035	.010
40	9.8	10	50	.004	.0035	.011
40	10.8	7	48	.004	.0035	.011
38	16.7	17	50	.005	.0035	.012
38	17.3	7	46	.005	.0035	.012
36	25.5	26	50	.006	.0035	.013
36	29.2	19	48	.006	.0035	.013
36	28.0	41	50	.007	.0035	.014
34	40.2	41	50	.007	.0035	.014
34	40.2	10	44	.007	.0035	.014
34	39.4	16	46	.007	.0035	.014
34	40.0	10	44	.007	.0035	.014
32	63.7	65	50	.009	.0035	.016
32	64.1	26	46	.009	.0035	.016
32	64.0	16	44	.009	.0035	.016
30	101.1	41	46	.012	.0035	.019
30	100.0	25	44	.012	.0035	.019
29	128.2	52	46	.013	.0035	.020
28	160.2	65	46	.015	.0035	.022
28	160.0	40	44	.015	.0035	.022

Our standard colors for primary and overall jackets include: white, black, red, green, yellow, blue, brown, orange, gray and violet. Custom color and/or exact color match available; please contact our design team for your specific requirement.

*All measurements are in inches unless otherwise stated.*

[www.newenglandwire.com](http://www.newenglandwire.com)  
Tel: 603.838.6624

# Ultra Flexible Single & Multiconductor FEP Insulated Stainless Steel Cables 150 Volts, 200° C

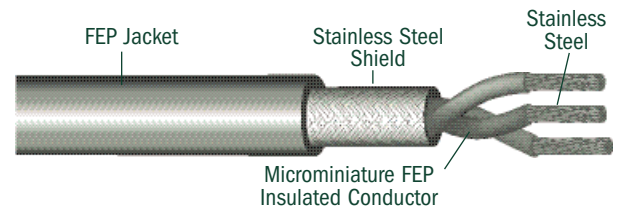

**DESCRIPTION:** Conductors are stainless steel insulated with 3.5 mil wall of FEP. Braided stainless steel shields of 44 AWG wire can be applied over the cabled conductors prior to jacketing with FEP.

**USE:** For use in flow probes and pressure measuring instruments where extreme flexibility and corrosion resistance are important. Please contact our design team to discuss your specific application.

Number of Conductors	SINGLE CONDUCTOR DATA				Nominal Diameter Over Cabled Conductor	SHIELD		JACKET	
	Equivalent AWG	Strand Construction	Nominal Wall Thickness	Nominal Diameter		AWG of Shield	Nominal Diameter Over Shield	Nominal Wall Thickness	Nominal OD
1	40	10/50	.0035	.011	.011	44	.020	.006	.032
1	38	17/50	.0035	.012	.012	44	.021	.006	.033
1	36	26/50	.0035	.013	.013	44	.022	.006	.034
1	34	41/50	.0035	.014	.014	44	.023	.006	.035
1	33	52/50	.0035	.015	.015	44	.024	.006	.036
1	32	65/50	.0035	.016	.016	44	.025	.006	.037
1	31	75/50	.0035	.017	.017	44	.026	.006	.038
1	30	41/46	.0035	.019	.019	44	.028	.006	.040
1	28	65/46	.0035	.022	.022	44	.031	.006	.043
2	40	10/50	.0035	.011	.021	44	.030	.006	.042
2	38	17/50	.0035	.012	.023	44	.032	.006	.044
2	36	26/50	.0035	.013	.025	44	.034	.006	.046
2	34	41/50	.0035	.014	.027	44	.036	.006	.048
2	33	52/50	.0035	.015	.029	44	.038	.006	.050
2	32	65/50	.0035	.016	.031	44	.040	.006	.052
2	31	75/50	.0035	.017	.033	44	.042	.006	.054
2	30	41/46	.0035	.019	.037	44	.046	.006	.058
2	28	65/46	.0035	.022	.043	44	.052	.006	.064
3	40	10/50	.0035	.011	.024	44	.033	.006	.045
3	38	17/50	.0035	.012	.026	44	.035	.006	.047
3	36	26/50	.0035	.013	.028	44	.037	.006	.049
3	34	41/50	.0035	.014	.030	44	.039	.006	.051
3	33	52/50	.0035	.015	.032	44	.041	.006	.053
3	32	65/50	.0035	.016	.034	44	.043	.006	.055
3	31	75/50	.0035	.017	.037	44	.046	.006	.058
3	30	41/46	.0035	.019	.041	44	.050	.006	.062
3	28	65/46	.0035	.022	.047	44	.056	.006	.068
4	40	10/50	.0035	.011	.027	44	.036	.006	.048
4	38	17/50	.0035	.012	.029	44	.038	.006	.050
4	36	26/50	.0035	.013	.031	44	.040	.006	.052
4	34	41/50	.0035	.014	.034	44	.043	.006	.055
4	33	52/50	.0035	.015	.036	44	.045	.006	.057
4	32	65/50	.0035	.016	.039	44	.048	.006	.060
4	31	75/50	.0035	.017	.041	44	.050	.006	.062
4	30	41/46	.0035	.019	.046	44	.055	.006	.067
4	28	65/46	.0035	.022	.053	44	.062	.006	.074

Our standard colors for primary and overall jackets include: white, black, red, green, yellow, blue, brown, orange, gray and violet. Custom color and/or exact color match available; please contact our design team for your specific requirement.

All measurements are in inches unless otherwise stated.



# Ultra Flexible Single & Multiconductor PFA Insulated Cables 125 Volts, 260° C

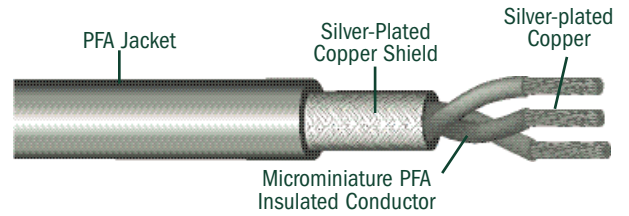

**DESCRIPTION:** Conductors are ultra flexible silver-plated copper strands insulated with 3.5 mil walls of PFA. Extra flexible silver-plated copper braided shields can be applied over the cabled conductors prior to jacketing with PFA.

**USE:** Used primarily in medical instruments such as transducers, flow probes, peripheral telemetry equipment and other specialized applications where strong, ultra flexible, microminiature multiconductor cables are required. Please contact our design team for constructions applicable to your specific requirements.

Number of Conductors	SINGLE CONDUCTOR DATA				Nominal Diameter Over Cabled Conductor	SHIELD		JACKET	
	Equivalent AWG	Strand Construction	Nominal Wall Thickness	Nominal Diameter		AWG of Shield	Nominal Diameter Over Shield	Nominal Wall Thickness	Nominal OD
1	40	10/50	.0035	.011	.011	44	.020	.006	.032
1	38	17/50	.0035	.012	.012	44	.021	.006	.033
1	36	26/50	.0035	.013	.013	44	.022	.006	.034
1	34	41/50	.0035	.014	.014	44	.023	.006	.035
1	33	52/50	.0035	.015	.015	44	.024	.006	.036
1	32	65/50	.0035	.016	.016	44	.025	.006	.037
1	31	75/50	.0035	.017	.017	44	.026	.006	.038
1	30	41/46	.0035	.019	.019	44	.028	.006	.040
1	28	65/46	.0035	.022	.022	44	.031	.006	.043
2	40	10/50	.0035	.011	.022	44	.031	.006	.043
2	38	17/50	.0035	.012	.024	44	.033	.006	.045
2	36	26/50	.0035	.013	.025	44	.034	.006	.046
2	34	41/50	.0035	.014	.027	44	.036	.006	.048
2	33	52/50	.0035	.015	.029	44	.038	.006	.050
2	32	65/50	.0035	.016	.031	44	.040	.006	.052
2	31	75/50	.0035	.017	.033	44	.042	.006	.054
2	30	41/46	.0035	.019	.037	44	.046	.006	.058
2	28	65/46	.0035	.022	.044	44	.053	.006	.065
3	40	10/50	.0035	.011	.024	44	.033	.006	.045
3	38	17/50	.0035	.012	.026	44	.035	.006	.047
3	36	26/50	.0035	.013	.028	44	.037	.006	.049
3	34	41/50	.0035	.014	.030	44	.039	.006	.051
3	33	52/50	.0035	.015	.032	44	.041	.006	.053
3	32	65/50	.0035	.016	.034	44	.043	.006	.055
3	31	75/50	.0035	.017	.037	44	.046	.006	.058
3	30	41/46	.0035	.019	.041	44	.050	.006	.062
3	28	65/46	.0035	.022	.047	44	.056	.006	.068
4	40	10/50	.0035	.011	.027	44	.036	.006	.048
4	38	17/50	.0035	.012	.029	44	.038	.006	.050
4	36	26/50	.0035	.013	.031	44	.040	.006	.052
4	34	41/50	.0035	.014	.034	44	.043	.006	.055
4	33	52/50	.0035	.015	.036	44	.045	.006	.057

Our standard colors for primary and overall jackets include: white, black, red, green, yellow, blue, brown, orange, gray and violet. Custom color and/or exact color match available; please contact our design team for your specific requirement.

All measurements are in inches unless otherwise stated.

**www.newenglandwire.com**  
**Tel: 603.838.6624**



# Ultra Flexible Single & Multiconductor Silicone Rubber Insulated Cables 300 Volts, 150° C

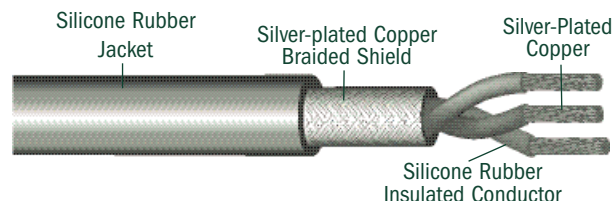

**DESCRIPTION:** Conductors are ultra flexible silver-plated copper strands insulated with silicone rubber. Extra flexible, silver-plated copper braided shields can be applied over the cabled conductors prior to jacketing with silicone rubber. For special applications, spiral shields can be substituted for braided shields.

**USE:** For use on various medical instruments and medical appliances where ultra flexibility and small diameters are desired. Used also in computer and monitoring equipment where extreme flexibility is required. Please contact our design team for your specific requirement.

Number of Conductors	SINGLE CONDUCTOR DATA				Nominal Diameter Over Cabled Conductor	SHIELD		JACKET	
	Equivalent AWG	Strand Construction	Nominal Wall Thickness	Nominal Diameter		AWG of Shield	Nominal Diameter Over Shield	Nominal Wall Thickness	Nominal OD
1	40	10/50	.010	.024	.024	44	.033	.010	.053
1	38	17/50	.010	.025	.025	44	.034	.010	.054
1	36	26/50	.010	.026	.026	44	.035	.010	.055
1	34	41/50	.010	.027	.027	44	.036	.010	.056
1	32	65/50	.010	.029	.029	44	.038	.010	.058
1	31	75/50	.010	.030	.030	44	.039	.010	.059
1	30	41/46	.010	.032	.032	44	.041	.010	.061
1	28	65/46	.010	.035	.035	44	.044	.010	.064
2	40	10/50	.010	.024	.047	44	.056	.010	.076
2	38	17/50	.010	.025	.049	44	.058	.010	.078
2	36	26/50	.010	.026	.051	44	.060	.010	.080
2	34	41/50	.010	.027	.053	44	.062	.010	.082
2	32	65/50	.010	.029	.057	44	.066	.010	.086
2	31	75/50	.010	.030	.059	44	.068	.010	.088
2	30	41/46	.010	.032	.063	44	.072	.010	.092
2	28	65/46	.010	.035	.070	44	.079	.015	.109
3	40	10/50	.010	.024	.052	44	.061	.010	.081
3	38	17/50	.010	.025	.054	44	.063	.010	.083
3	36	26/50	.010	.026	.056	44	.065	.010	.085
3	34	41/50	.010	.027	.058	44	.067	.010	.087
3	32	65/50	.010	.029	.062	44	.071	.010	.091
3	31	75/50	.010	.030	.065	44	.074	.010	.094
3	30	41/46	.010	.032	.069	44	.078	.015	.108
3	28	65/46	.010	.035	.075	44	.084	.015	.114
4	40	10/50	.010	.024	.058	44	.067	.010	.087
4	38	17/50	.010	.025	.060	44	.069	.010	.089
4	36	26/50	.010	.026	.063	44	.072	.010	.092
4	34	41/50	.010	.027	.065	44	.074	.010	.094
4	32	65/50	.010	.029	.070	44	.079	.015	.109
4	31	75/50	.010	.030	.072	44	.081	.015	.111
4	30	41/46	.010	.032	.077	44	.086	.015	.116
4	28	65/46	.010	.035	.084	44	.093	.015	.123
5	40	10/50	.010	.024	.065	44	.074	.010	.104
5	38	17/50	.010	.025	.068	44	.077	.015	.107
5	36	26/50	.010	.026	.070	44	.079	.015	.109
5	34	41/50	.010	.027	.073	44	.082	.015	.112
5	32	65/50	.010	.029	.079	44	.088	.015	.118
5	31	75/50	.010	.030	.081	44	.090	.015	.120
5	30	41/46	.010	.032	.087	44	.095	.015	.126
5	28	65/46	.010	.035	.095	44	.104	.015	.134

All measurements are in inches unless otherwise stated.

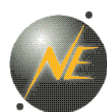

NEW ENGLAND WIRE TECHNOLOGIES  
Innovate. Create. Accelerate.

No industry demands more technologically advanced cables built to more exacting specifications than medical electronics. And no company has more experience or expertise researching, developing, and manufacturing precision cables for medical applications than New England Wire Technologies.

Our low-noise, high-temperature and vented cables are at work in pulse oximetry devices, electrosurgical instruments, fetal monitors, nerve stimulation devices, defibrillators, and more. And our precision braid reinforced tubings are used in the design and production of a number of custom components for the medical device marketplace.

When signal integrity is important to accurate diagnosis and monitoring, our NEWtral<sup>®</sup>, NEWtuf<sup>®</sup>, and NEWcel<sup>®</sup> cables are the answer. NEWtral<sup>®</sup> low-noise cables reduce or eliminate problems associated with spurious electrical disturbances caused by self-generated, mechanically induced noise. NEWtuf<sup>®</sup> silicone rubber jackets protect inner conductors from longitudinal stresses and the rigors of everyday use. And our NEWcel<sup>®</sup> cables improve signal propagation, protecting the integrity of clinical information.

We invite you to call our sales department to discuss your current needs for custom designed wires and cables using a variety of conductors and insulating materials for medical electronics applications.

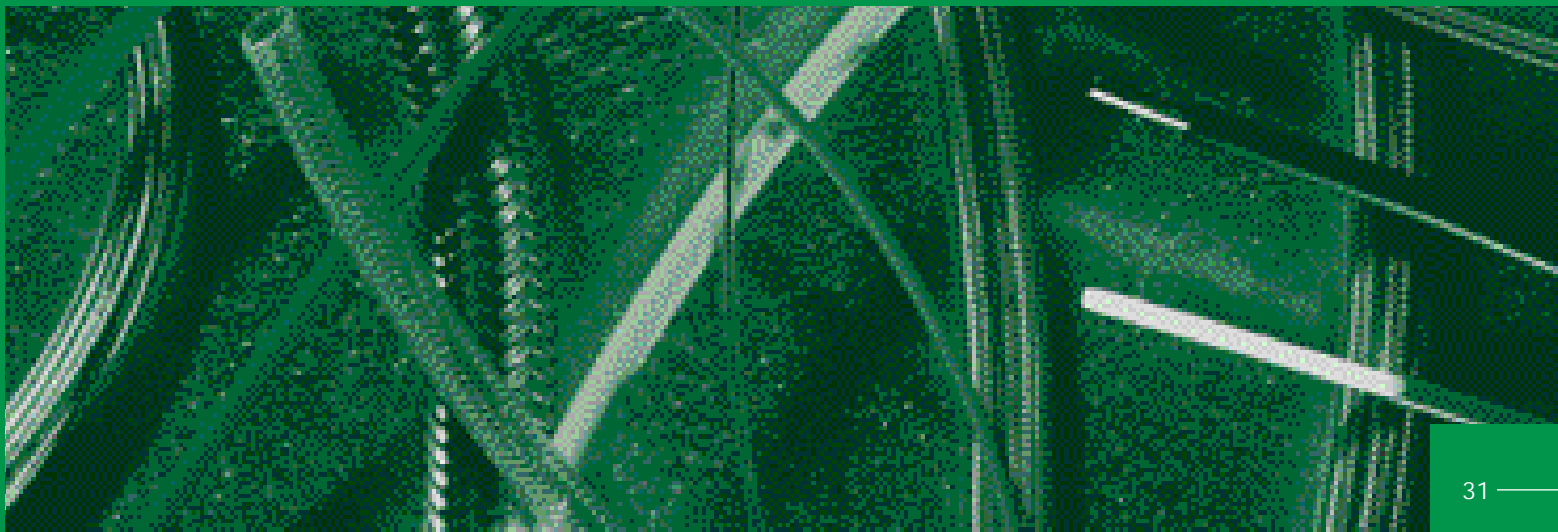

## MEDICAL CABLES

The capability to provide custom designed wires and cables with various types of conductors and insulating materials allow New England Wire Technologies to support wire and cable requirements for diverse medical equipment applications such as digital imaging, electro surgery, patient monitoring, ultrasound and laser surgery. Characteristics of our products include ultraflexible, high-flex life, autoclavable, low-noise, low-elongation/high tensile strength and miniaturization.

The composite cable constructions and families of cables shown on the following pages are intended to demonstrate the variety of custom cable configurations we can manufacture. Cables utilizing many more conductors, various high-strength copper alloys and other extruded insulations are available.

Medical Composite Cables . . . . .	33
Ultra Flexible Silicone Rubber . . . . .	36
Extra Flexible Silicone Rubber . . . . .	37
Ultra Flexible FEP & Polyurethane . . . . .	39
Ultra Flexible PFA & Silicone Rubber . . . . .	41
Ultra Flexible PFA Lead Wire . . . . .	43
Ultra Flexible FEP Stainless Steel . . . . .	44
Ultra Flexible PFA . . . . .	45
Ultra Flexible PVC . . . . .	47
NEWtral® Low-Noise Cables . . . . .	49
NEWtuf® Reinforced Silicone Rubber . . . . .	50

# MEDICAL COMPOSITE CABLES

New England Wire Technologies offers an extensive range of sophisticated wire and cable products for the medical device manufacturer. Working with customer supplied requirements, our design and engineering staff specialize in product development, concurrent engineering, design for manufacturability and quick turn prototyping. The next few pages demonstrate a few of our design and manufacturing capabilities. Please call our design team to discuss your specific application.

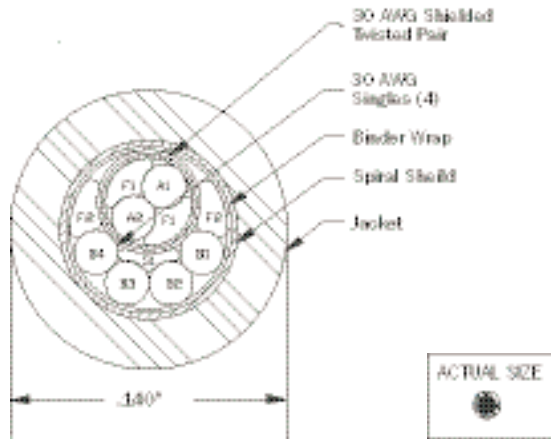

**6 Conductor Cable:** 30 AWG tinned copper shielded twisted pair, 4 - 30 AWG singles and fillers cabled around Aramid core then taped, shielded and jacketed with PVC to 0.140" O.D.

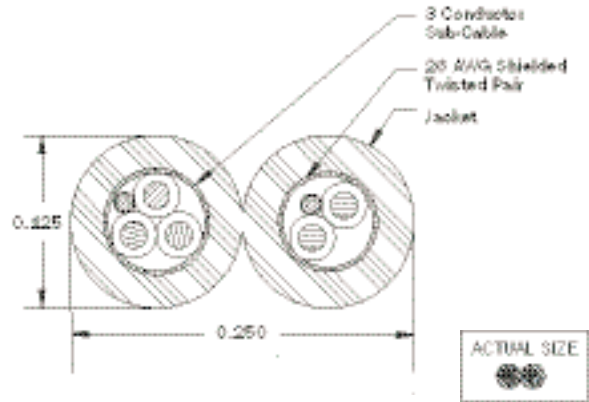

**5 Conductor Zip Cord:** 3 conductor shielded sub-cable, and shielded, twisted pair laid parallel then jacketed with silicone rubber to 0.125" by 0.250" wide.

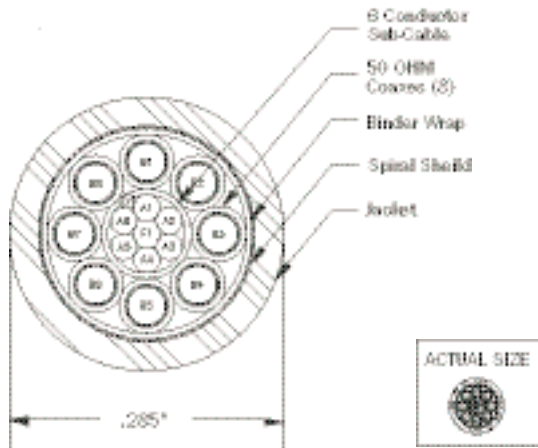

**14 Conductor Cable:** 8 - 50 OHM NEWtral-E coaxes with PFA jackets cabled around 6 conductor sub-cable and then taped, spiral shielded and jacketed with polyurethane to 0.285" O.D.

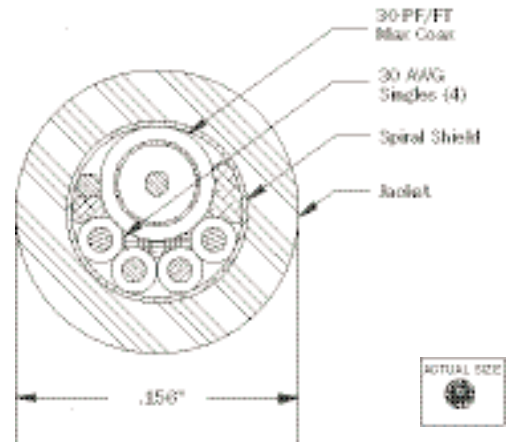

**5 Conductor Cable:** 4 - 30 AWG Newaloy 61 polypropylene singles and a coax cabled around core with fillers; then spiral shielded and jacketed with polyurethane to 0.156" O.D.

# MEDICAL COMPOSITE CABLES, *continued*

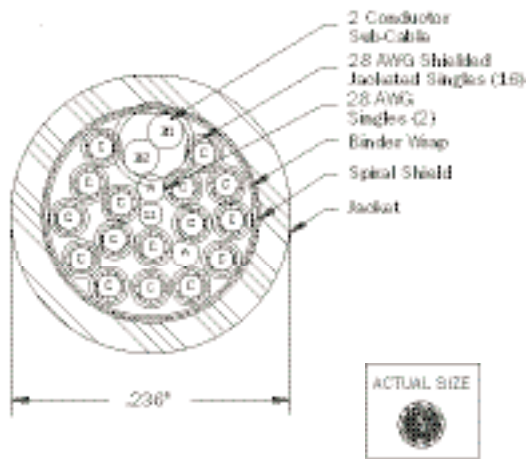

**20 Conductor Cable:** 2 conductor silver plated copper subcable with PFA jacket, 16 - 28 AWG NEWtral-E shielded and jacketed single and 2 - 28 AWG silver-plated copper conductors cabled and then taped, spiral shielded, and jacketed with polyurethane to 0.236" O.D.

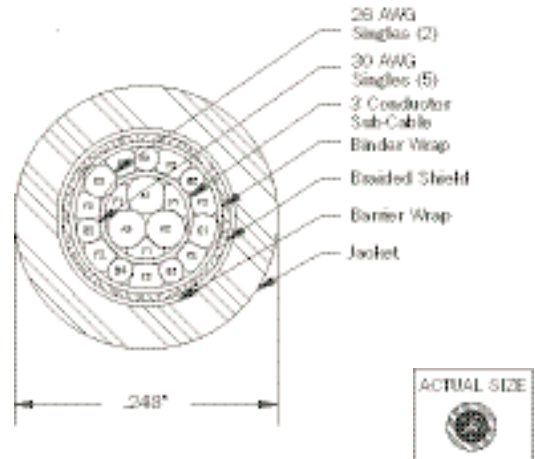

**20 Conductor Cable:** 5 - 30 AWG Newaloy 61 singles, 2 - 26 AWG singles and fillers cabled around 3 conductor PFA insulated subcable then taped, shielded, and jacketed with NEWtuf® to 0.248" O.D.

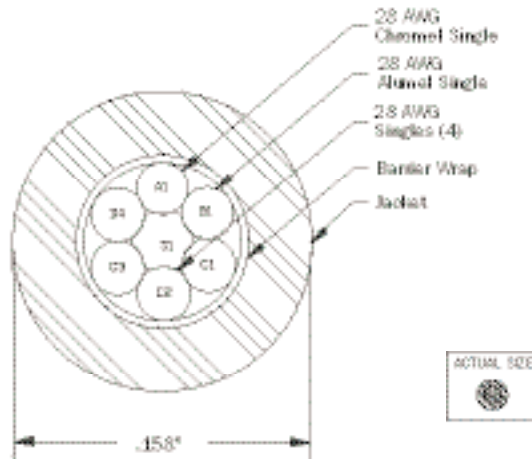

**6 Conductor Cable:** 28 AWG chromel single, 28 AWG alumel single and 4 - 28 AWG Newaloy 61 singles (all with PFA insulation) cabled around a core then taped and jacketed with silicone rubber to 0.158" O.D.

# Ultra Flexible Single & Multiconductor PFA Insulated Cables, *continued*

Number of Conductors	SINGLE CONDUCTOR DATA				Nominal Diameter Over Cabled Conductor	SHIELD		JACKET	
	Equivalent AWG	Strand Construction	Nominal Wall Thickness	Nominal Diameter		AWG of Shield	Nominal Diameter Over Shield	Nominal Wall Thickness	Nominal OD
4	32	65/50	.0035	.016	.039	44	.048	.006	.060
4	31	75/50	.0035	.017	.041	44	.050	.006	.062
4	30	41/46	.0035	.019	.046	44	.055	.006	.067
4	28	65/46	.0035	.022	.053	44	.062	.006	.069
5	40	10/50	.0035	.011	.030	44	.039	.006	.074
5	38	17/50	.0035	.012	.033	44	.042	.006	.051
5	36	26/50	.0035	.013	.035	44	.044	.006	.054
5	34	41/50	.0035	.014	.038	44	.047	.006	.056
5	33	52/50	.0035	.015	.041	44	.050	.006	.059
5	32	65/50	.0035	.016	.043	44	.052	.006	.062
5	31	75/50	.0035	.017	.046	44	.055	.006	.064
5	30	41/46	.0035	.019	.051	44	.060	.006	.067
5	29	52/46	.0035	.020	.054	44	.063	.006	.072
5	28	65/46	.0035	.022	.060	44	.069	.006	.081

Our standard colors for primary and overall jackets include: white, black, red, green, yellow, blue, brown, orange, gray and violet. Custom color and/or exact color match available; please contact our design team for your specific requirement.

*All measurements are in inches unless otherwise stated.*



# Ultra Flexible Single & Multiconductor PVC Insulated Cables 200 Volts, 105° C

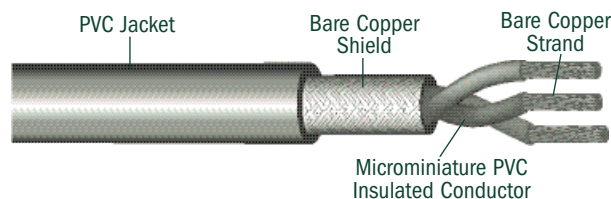

**DESCRIPTION:** Conductors are ultra flexible bare copper strands insulated with 5 mil walls of color coded PVC. Extra flexible braided bare copper shields over the cabled conductors are optional prior to jacketing with PVC. Many of these constructions are also available with tinned copper stranding and shields.

**USE:** Medical instruments and other specialized applications requiring ultra flexible microminiature multiconductor cables. Please contact our design team for your specific requirements.

Number of Conductors	SINGLE CONDUCTOR DATA				Nominal Diameter Over Cabled Conductor	SHIELD		JACKET	
	Equivalent AWG	Strand Construction	Nominal Wall Thickness	Nominal Diameter		AWG of Shield	Nominal Diameter Over Shield	Nominal Wall Thickness	Nominal OD
1	38	17/50	.005	.015	.015	44	.024	.010	.044
1	38	7/46	.005	.015	.015	44	.024	.010	.044
1	36	26/50	.005	.016	.016	44	.025	.010	.045
1	36	7/44	.005	.016	.016	44	.025	.010	.045
1	34	41/50	.005	.017	.017	44	.026	.010	.046
1	34	10/44	.005	.017	.017	44	.026	.010	.046
1	34	7/42	.005	.018	.018	44	.027	.010	.047
1	32	65/50	.005	.019	.019	44	.028	.010	.048
1	32	26/46	.005	.019	.019	44	.028	.010	.048
1	32	16/44	.005	.019	.019	44	.028	.010	.048
1	32	7/40	.005	.019	.019	44	.028	.010	.048
1	30	41/46	.005	.022	.022	44	.031	.010	.051
1	30	25/44	.005	.022	.022	44	.031	.010	.051
1	30	11/40	.005	.022	.022	44	.031	.010	.051
1	30	7/38	.005	.022	.022	44	.031	.010	.051
2	38	17/50	.005	.015	.029	44	.038	.010	.058
2	38	7/46	.005	.015	.029	44	.038	.010	.058
2	36	26/50	.005	.016	.031	44	.040	.010	.060
2	36	7/44	.005	.016	.031	44	.040	.010	.060
2	34	41/50	.005	.017	.033	44	.042	.010	.062
2	34	10/44	.005	.017	.033	44	.042	.010	.062
2	34	7/42	.005	.018	.035	44	.044	.010	.064
2	32	65/50	.005	.019	.037	44	.046	.010	.066
2	32	26/46	.005	.019	.037	44	.046	.010	.066
2	32	16/44	.005	.019	.037	44	.046	.010	.066
2	32	7/40	.005	.019	.039	44	.048	.010	.068
2	30	41/46	.005	.022	.043	44	.052	.010	.072
2	30	25/44	.005	.022	.043	44	.052	.010	.072
2	30	11/40	.005	.022	.043	44	.052	.010	.072
2	30	7/38	.005	.022	.043	44	.052	.010	.072
3	38	17/50	.005	.015	.032	44	.041	.010	.061
3	38	7/46	.005	.015	.032	44	.041	.010	.061
3	36	26/50	.005	.016	.034	44	.043	.010	.063
3	36	7/44	.005	.016	.034	44	.043	.010	.063
3	34	41/50	.005	.017	.037	44	.046	.010	.066

Our standard colors for primary and overall jackets include: white, black, red, green, yellow, blue, brown, orange, gray and violet. Custom color and/or exact color match available; please contact our design team for your specific requirement.

All measurements are in inches unless otherwise stated.

www.newenglandwire.com  
Tel: 603.838.6624

# Ultra Flexible Single & Multiconductor PVC Insulated Cables, *continued*

Number of Conductors	SINGLE CONDUCTOR DATA				Nominal Diameter Over Cabled Conductor	SHIELD		JACKET	
	Equivalent AWG	Strand Construction	Nominal Wall Thickness	Nominal Diameter		AWG of Shield	Nominal Diameter Over Shield	Nominal Wall Thickness	Nominal OD
3	34	10/44	.005	.017	.037	44	.046	.010	.066
3	34	7/42	.005	.018	.039	44	.048	.010	.068
3	32	65/50	.005	.019	.041	44	.050	.010	.070
3	32	26/46	.005	.019	.041	44	.050	.010	.070
3	32	16/44	.005	.019	.041	44	.050	.010	.070
3	32	7/40	.005	.019	.041	44	.050	.010	.070
3	30	41/46	.005	.022	.047	44	.056	.010	.076
3	30	25/44	.005	.022	.047	44	.056	.010	.076
3	30	11/40	.005	.022	.047	44	.056	.010	.076
3	30	7/38	.005	.022	.047	44	.056	.010	.076
4	38	17/50	.005	.015	.032	44	.041	.010	.061
4	38	7/46	.005	.015	.036	44	.045	.010	.065
4	36	26/50	.005	.016	.039	44	.048	.010	.068
4	36	7/44	.005	.016	.039	44	.048	.010	.068
4	34	41/50	.005	.017	.041	44	.050	.010	.070
4	34	10/44	.005	.017	.041	44	.050	.010	.070
4	34	7/42	.005	.018	.043	44	.052	.010	.072
4	32	65/50	.005	.019	.046	44	.055	.010	.075
4	32	26/46	.005	.019	.046	44	.055	.010	.075
4	32	16/44	.005	.019	.046	44	.055	.010	.075
4	32	7/40	.005	.019	.046	44	.055	.010	.075
4	30	41/46	.005	.022	.053	44	.062	.010	.082
4	30	25/44	.005	.022	.053	44	.062	.010	.082
4	30	11/40	.005	.022	.053	44	.062	.010	.082
4	30	7/38	.005	.022	.053	44	.062	.010	.082
5	38	17/50	.005	.015	.041	44	.050	.010	.070
5	38	7/46	.005	.015	.041	44	.049	.010	.069
5	36	26/50	.005	.016	.043	44	.052	.010	.072
5	36	7/44	.005	.016	.043	44	.052	.010	.072
5	34	41/50	.005	.017	.046	44	.055	.010	.075
5	34	10/44	.005	.017	.046	44	.055	.010	.075
5	34	7/42	.005	.018	.049	44	.058	.010	.078
5	32	65/50	.005	.019	.051	44	.060	.010	.080
5	32	26/46	.005	.019	.051	44	.060	.010	.080
5	32	16/44	.005	.019	.051	44	.060	.010	.080
5	32	7/40	.005	.019	.051	44	.060	.010	.080
5	30	41/46	.005	.022	.059	44	.068	.010	.088
5	30	25/44	.005	.022	.059	44	.068	.010	.088
5	30	11/40	.005	.022	.059	44	.068	.010	.088
5	30	7/38	.005	.022	.059	44	.068	.010	.088

Our standard colors for primary and overall jackets include: white, black, red, green, yellow, blue, brown, orange, gray and violet. Custom color and/or exact color match available; please contact our design team for your specific requirement.

*All measurements are in inches unless otherwise stated.*





# NEWtral® LOW-NOISE CABLES

## TECHNICAL INFORMATION

In small signal applications, noise-free transmission lines are necessary to maintain signal integrity. Simply flexing or twisting a traditional cable can generate voltage spikes with magnitudes in the tens of millivolts. This noise is due to triboelectric charging of the insulator materials, which act as capacitors and store the charge. The addition of conductive low-noise layers reduces this noise to the microvolt range.

New England Wire Technologies has specifically developed a range of advanced low-noise cables designed to neutralize noise generated by mechanical shock and vibration and maximize signal quality.

Typical applications include medical equipment, test and measurement equipment, charge amplifiers, vibration analyzers and oscilloscopes.

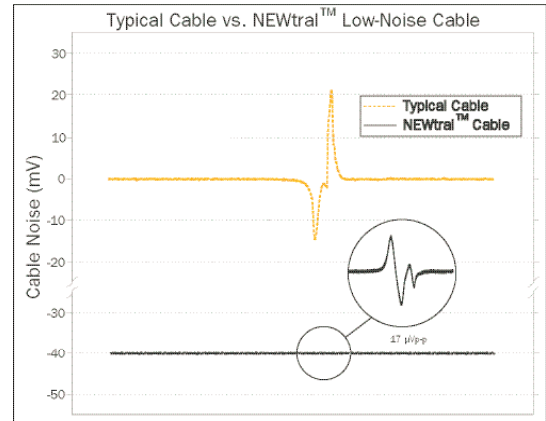

## NEWtral® Type 1

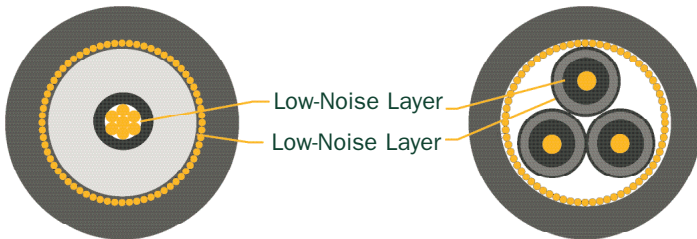

**Advantage:**

Excellent performance (10  $\mu$ V - 100  $\mu$ V)

**Consideration:**

Increase in primary diameter (.010"-.020")

## NEWtral® Type 2

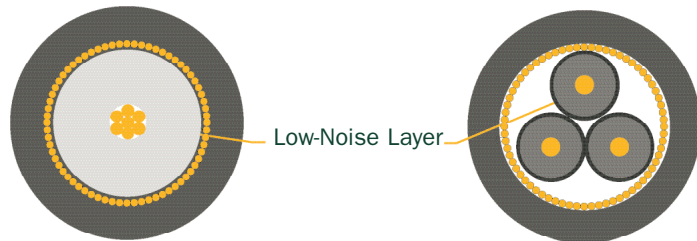

**Advantage:**

Very good performance (25  $\mu$ V - 250  $\mu$ V)

**Consideration:**

Low cost

## Outer Low-Noise Layer Options

### Extruded

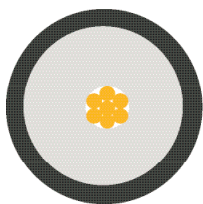

**Advantage:**  
 \*Can be stripped mechanically.  
 \*Low cost

**Consideration:**  
 \*Diameter increase (.010-.020")

### Coated

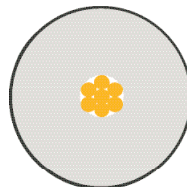

**Advantage:**  
 \*No diameter increase.  
 \*Low Cost

**Consideration:**  
 \*Must be chemically stripped

### EZ- Strip

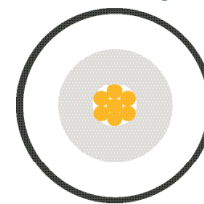

**Advantage:**  
 \*Can be stripped mechanically.  
 \*No diameter increase.

**Consideration:**  
 \*Higher Cost

[www.newenglandwire.com](http://www.newenglandwire.com)

Tel: 603.838.6624

# NEWtuf® REINFORCED JACKETS

## TECHNICAL INFORMATION

Silicone rubber is preferred over other jacketing materials due to its high flexibility, performance at high temperatures and ease of sterilization. Certain medical applications require that cable jackets be cleaned by wiping the surface with solvents. Conventional silicone rubber jackets may become stretched and distorted during the cleaning process. Furthermore it is desirable to limit the elongation of the jacket in some silicone rubber jacketed cable assemblies when equipped with molded connectors.

With a peak strength three times that of conventional silicone rubber, NEWtuf® reinforced jackets withstand axial forces without reducing flexibility. Although tougher than conventional silicone rubber, the jacket can still be easily stripped with standard equipment.

150°C/300V UL AWM Stles are available for medical instrument interconnecting cable applications.

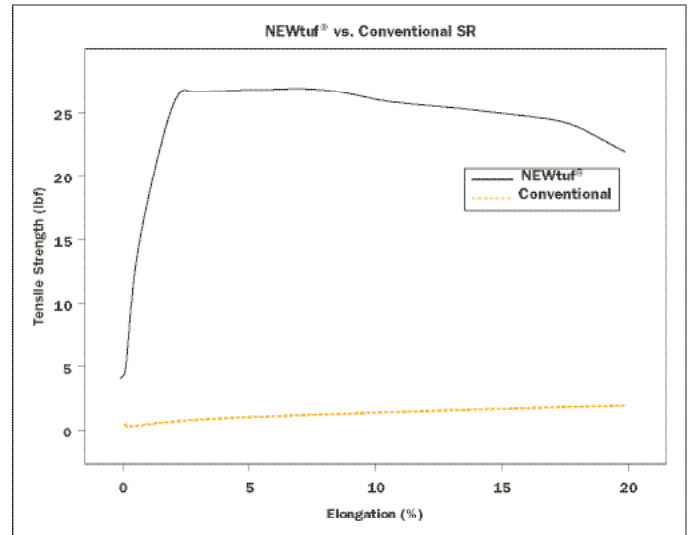

When a force is applied, NEWtuf® exhibits very little elongation unlike conventional silicone rubber jackets.

## PRODUCT ADVANTAGES

- \* High Tensile Strength
- \* Low Elongation
- \* Autoclavable
- \* High Flexibility
- \* Excellent High-Temperature Integrity

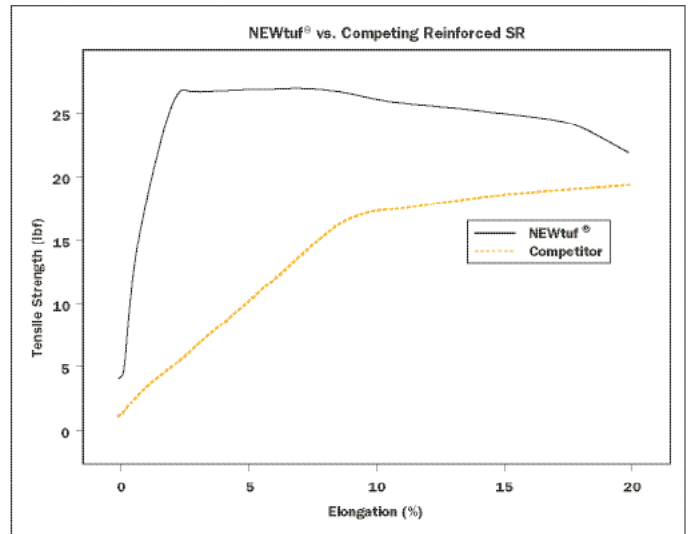

A comparison of the performance of NEWtuf® vs. competing reinforced jackets proves NEWtuf® to be superior.

## Material Properties

Property	Conventional	NEWtuf®	Competitor
Elongation 5 lbf	86%	0.03%	2.0%
Elongation 20 lbf	490%	1.0%	20%





## INSTRUMENTATION/TEST & MEASUREMENT CABLES

New England Wire Technologies has the technical knowledge necessary for designing cables to maximize accuracy and durability of test and measurement equipment. We are widely recognized for our ability to produce cables with extra flexibility, extended flex life and low noise—characteristics that are essential in medical electronics, scientific research, geology, robotics and general electronics.

Our ultra flexible cables are the right choice when the unrestricted motion of an instrument is vital. We combine finely stranded conductors and thin-wall extrusions to produce cables with extreme flexibility. For applications where high reliability in repeated motion operations is a must, our high-flex multiconductor cables unite high strength alloys with abrasion-resistant plastic insulations to create cable products with superior, long-term flex life. Our NEWtral® low noise cables help reduce or eliminate internal noise generation to improve the accuracy and reliability of electronic signals. Our geophysical and scientific cables are built to withstand the rigors of both field and laboratory use. All can be manufactured to your exact specifications.

Contact our sales department to find out how we can design custom cable solutions for your test and measurement applications.



## **INSTRUMENTATION/TEST & MEASUREMENT CABLES**

New England Wire Technologies' high degree of technical knowledge and manufacturing expertise ensure cables are manufactured with the reliability, performance and durability required for today's sophisticated instrumentation and control cable applications. Our broad range of manufacturing capabilities along with a wide selection of conductor and insulation materials allow us to produce world-class cables with characteristics such as: low-noise, extra-flexibility, extended flexlife, miniaturization, high/low temperature performance, precise electrical properties and corrosion resistance. Please contact our design team to discuss your specific application requirements.

Instrumentation Composite Cables . . . . .	53
Ultra Flexible PFA & Silicone Rubber . . . . .	56
PFA & PFA . . . . .	58
FEP & TPE . . . . .	60
PVC & Polyester . . . . .	62
PVC & TPE . . . . .	64
PVC & Polyurethane . . . . .	66
PVC & PVC . . . . .	69

# INSTRUMENTATION COMPOSITE CABLES

New England Wire Technologies offers a wide range of ultra flexible cables designed to maximize accuracy and durability of test and measurement equipment used in medical electronics, scientific research, geology, robotics and general electronics. Our cables can be produced with extra flexibility, extended flex-life and low noise. The development of these unique cables has been possible by combining our ultra fine wire stranding technology with the capability of extruded thin walls of Polyester, Polyethylene, Polyurethane, PVC, FEP, PFA and Silicone Rubber insulations. The next few pages demonstrate a few of our design and manufacturing capabilities. Please call our design team today to start working on a custom cable solution for your specific requirement.

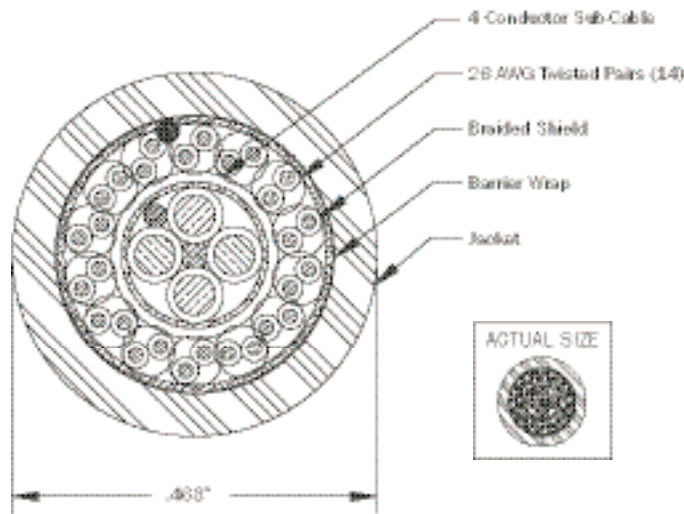

**32 Conductor Cable:** 14 - 26 AWG twisted pairs and drain-wire cabled around a 4 conductor sub-cable with core and drain wire then shielded, wrapped and jacketed with TPE to 0.468" O.D.

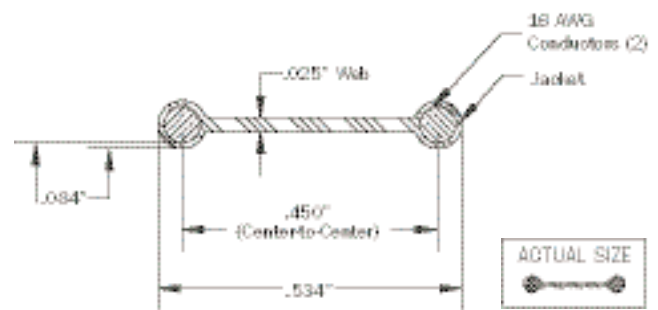

**200 Ohm Antenna Cable:** 2 - 16 AWG silver-plated copper clad steel conductors laid parallel and extruded in dog-bone configuration with ETFE to 0.534" wide.

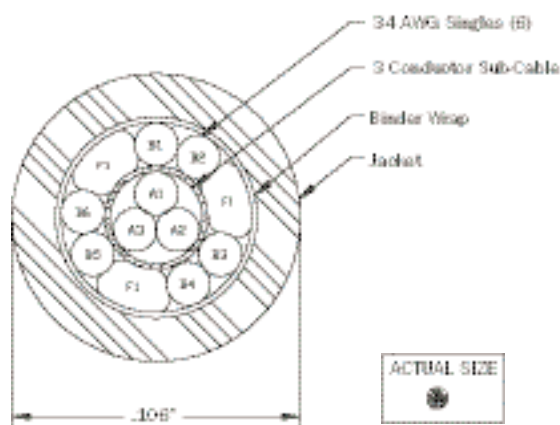

**9 Conductor Cable:** 6 - 34 AWG silver-plated alloy singles cabled with fillers around 3 conductor sub-cable, then wrapped and jacketed with polyurethane to 0.106" O.D.

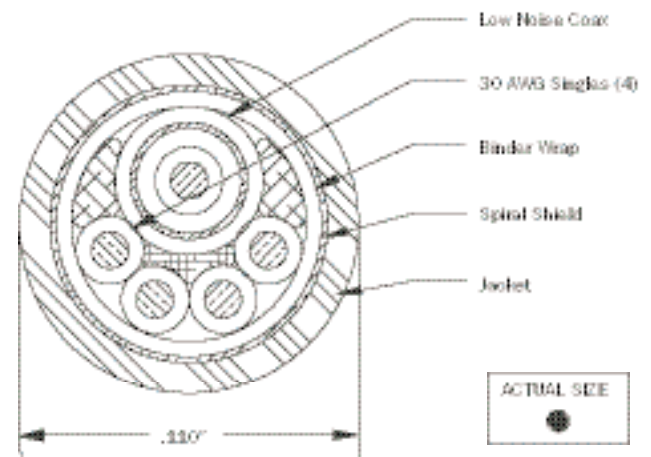

**5 Conductor Cable:** Low noise coax and 4 PVC insulated singles cabled around aramid core with fillers, then wrapped, spiral shielded and jacketed with PVC to 0.110" O.D.

[www.newenglandwire.com](http://www.newenglandwire.com)

Tel: 603.838.6624

# INSTRUMENTATION COMPOSITE CABLES, *continued*

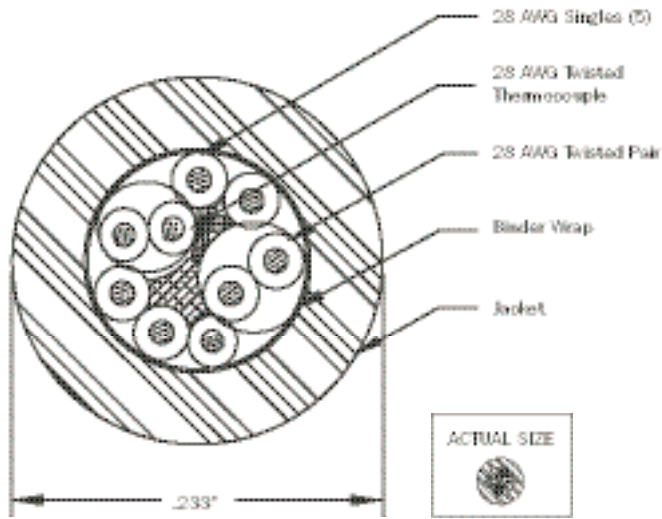

**9 Conductor Cable:** 5 - 28 AWG tinned copper singles, 28 AWG twisted thermocouple and 28 AWG twisted pair cabled around core, wrapped and jacketed with TPE to 0.233" O.D.

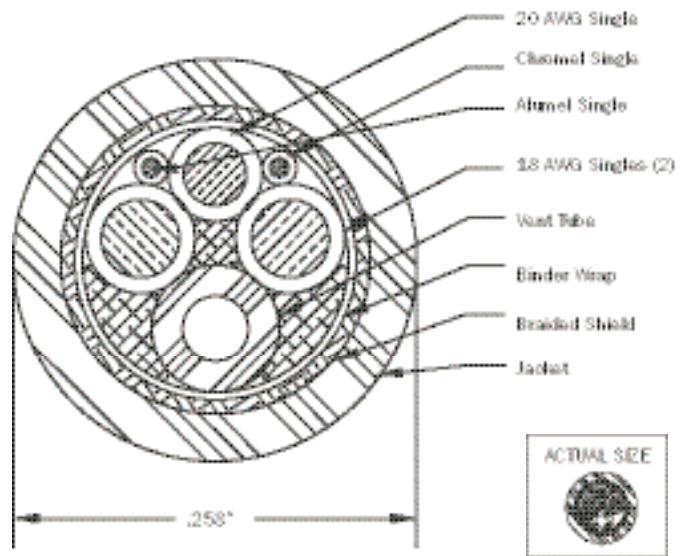

**5 Conductor Cable:** 20 AWG tinned copper single, 2 - 18 AWG tinned copper singles and vent tube, chromel single, alumel single and 2 fillers cabled around a core, wrapped, shielded and jacketed with silicone rubber to 0.258".

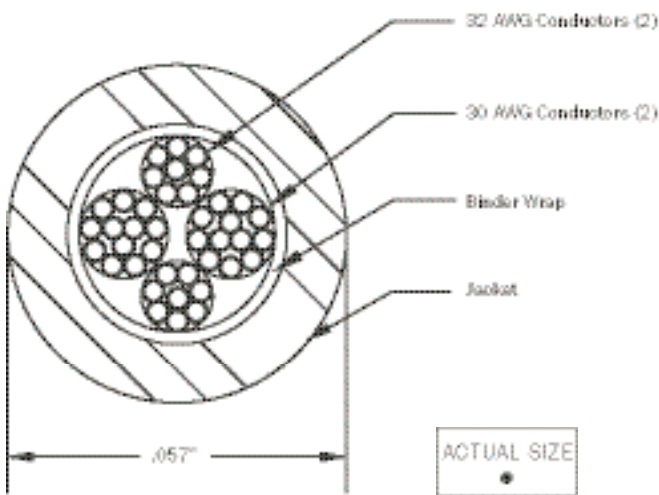

**4 Conductor Litz:** 2 - 32 AWG Polyurethane conductors and 2 - 30 AWG Polyurethane conductors, cabled then foil wrapped and jacketed with Polyurethane to 0.057" O.D.

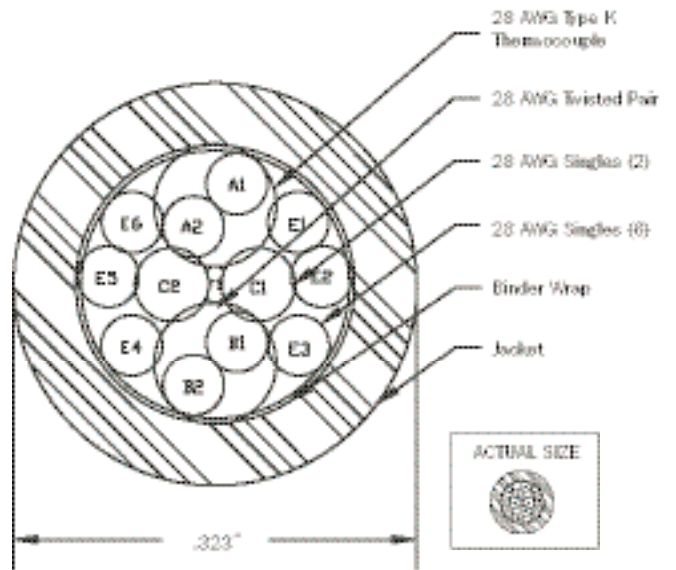

**12 Conductor Cable:** 28 AWG Type K thermocouple, hard tinned newaloy twisted pair, 2 - Newaloy/PFA singles and 6 - PFA insulated singles bunched around a filler, then binder wrapped and jacketed with silicone rubber to 0.323" O.D.

# INSTRUMENTATION COMPOSITE CABLES, *continued*

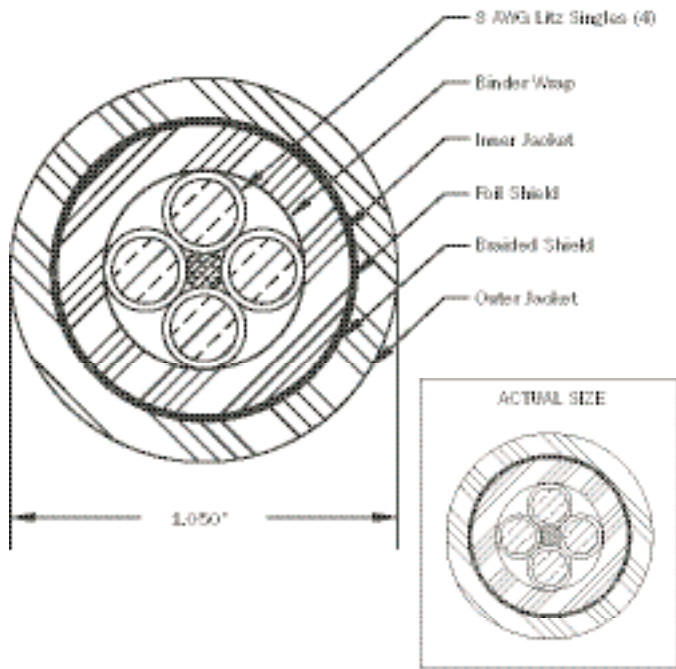

**4 Conductor Cable:** 4 - 8 AWG Litz singles cabled around filler to form a core which is then wrapped and jacketed with PVC prior to applying foil shield, braided shield and PVC outer jacket to 1.05" O.D.

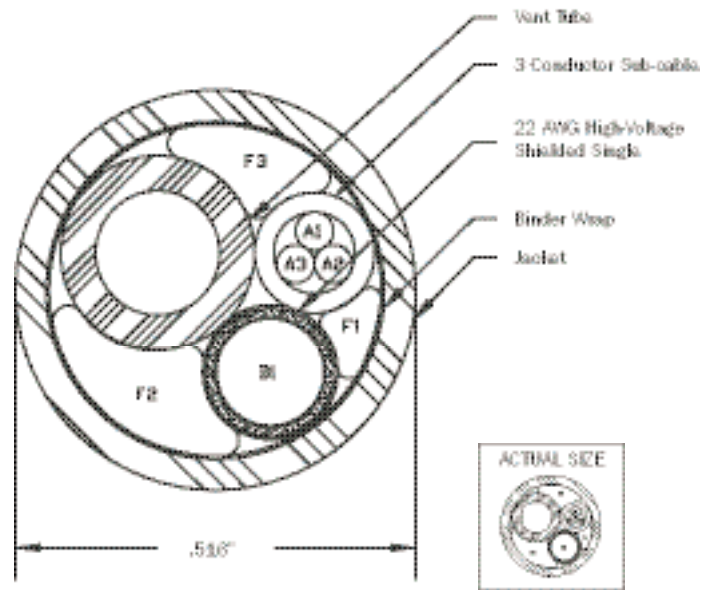

**4 Conductor Cable:** 3 conductor sub-cable, 22 AWG high voltage shielded single and vent tube cabled with fillers, wrapped and jacketed with polyurethane to 0.516" O.D.

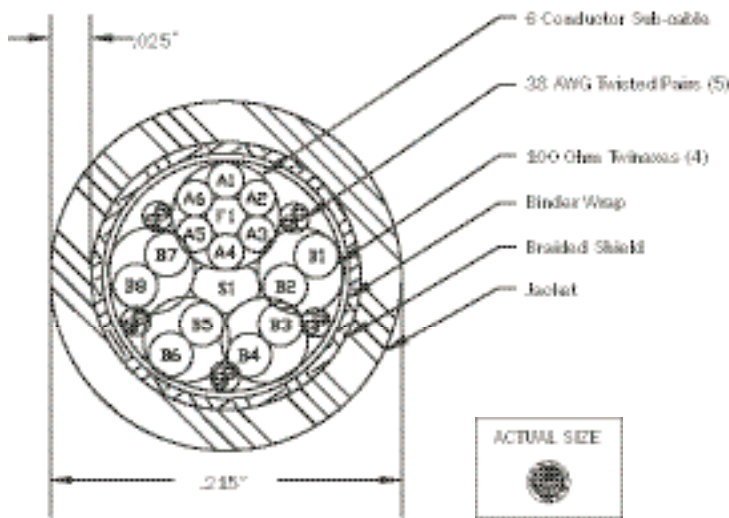

**4 Conductor Cable:** 4 twinaxes, 6 conductor sub-cable, and 5 - 38 AWG twisted pairs cabled around strength member, wrapped, shielded and jacketed with polurethane to 0.215" O.D.

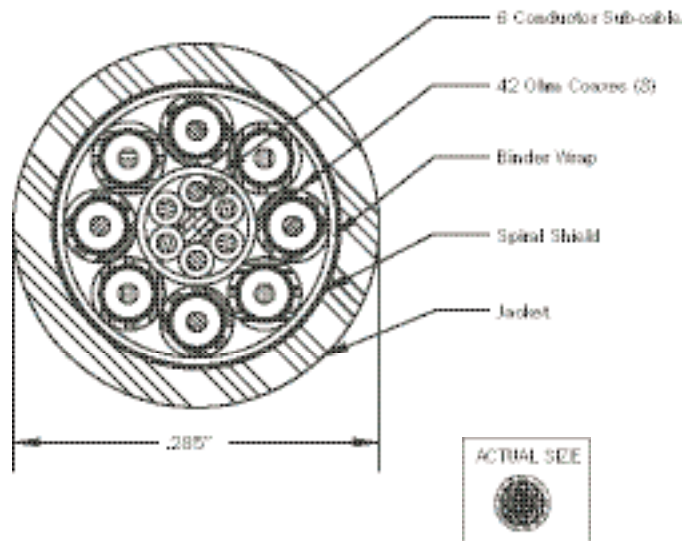

**14 Conductor Cable:** 8 - 42 OHM silver-plated coaxes with low-noise coating cabled around silver-plated 6 conductor cable with drain wire in outer interstice then taped, wrapped, spiral shielded and jacketed with polyurethane to 0.285" O.D.

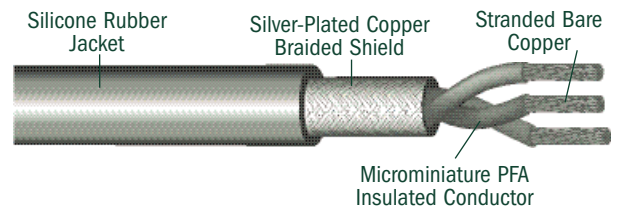

**DESCRIPTION:** Conductors are ultra flexible bare copper strands insulated with 5 mil walls of color coded PFA. Extra flexible braided shields can be applied over the cabled conductors before jacketing with silicone rubber.

**USE:** For use in applications requiring good flexibility, high temperature and other specialized applications. Most of the items below are also available with tinned copper stranded conductors and shields; please contact our design team for your specific requirements.

Number of Conductors	SINGLE CONDUCTOR DATA				Nominal Diameter Over Cabled Conductor	SHIELD		JACKET	
	Equivalent AWG	Strand Construction	Nominal Wall Thickness	Nominal Diameter		AWG of Shield	Nominal Diameter Over Shield	Nominal Wall Thickness	Nominal OD
1	38	17/50	.005	.015	.015	44	.024	.010	.044
1	38	7/46	.005	.015	.015	44	.024	.010	.044
1	36	26/50	.005	.016	.016	44	.025	.010	.045
1	36	7/44	.005	.016	.016	44	.025	.010	.045
1	34	41/50	.005	.017	.017	44	.026	.010	.046
1	34	10/44	.005	.017	.017	44	.026	.010	.046
1	34	7/42	.005	.018	.018	44	.027	.010	.047
1	32	65/50	.005	.019	.019	44	.028	.010	.048
1	32	26/46	.005	.019	.019	44	.028	.010	.048
1	32	16/44	.005	.019	.019	44	.028	.010	.048
1	32	7/40	.005	.019	.019	44	.028	.010	.048
1	30	41/46	.005	.022	.022	44	.031	.010	.051
1	30	25/44	.005	.022	.022	44	.031	.010	.051
1	30	11/40	.005	.022	.022	44	.031	.010	.051
1	30	7/38	.005	.022	.022	44	.031	.010	.051
2	38	17/50	.005	.015	.029	44	.038	.010	.058
2	38	7/46	.005	.015	.029	44	.038	.010	.058
2	36	26/50	.005	.016	.031	44	.040	.010	.060
2	36	7/44	.005	.016	.031	44	.040	.010	.060
2	34	41/50	.005	.017	.033	44	.042	.010	.062
2	34	10/44	.005	.017	.033	44	.042	.010	.062
2	34	7/42	.005	.018	.035	44	.044	.010	.064
2	32	65/50	.005	.019	.037	44	.046	.010	.066
2	32	26/46	.005	.019	.037	44	.046	.010	.066
2	32	16/44	.005	.019	.037	44	.046	.010	.066
2	32	7/40	.005	.019	.037	44	.046	.010	.066
2	30	41/46	.005	.022	.043	44	.052	.010	.072
2	30	25/44	.005	.022	.043	44	.052	.010	.072
2	30	11/40	.005	.022	.043	44	.052	.010	.072
2	30	7/38	.005	.022	.043	44	.052	.010	.072
3	38	17/50	.005	.015	.032	44	.041	.010	.061
3	38	7/46	.005	.015	.032	44	.041	.010	.061
3	36	26/50	.005	.016	.034	44	.043	.010	.063
3	36	7/44	.005	.016	.034	44	.043	.010	.063
3	34	41/50	.005	.017	.037	44	.046	.010	.066

Our standard colors for primary and overall jackets include: white, black, red, green, yellow, blue, brown, orange, gray and violet. Custom color and/or exact color match available; please contact our design team for your specific requirement.

All measurements are in inches unless otherwise stated.



# Ultra Flexible Single & Multiconductor PFA & Silicone Rubber Insulated Cables, *continued*

Number of Conductors	SINGLE CONDUCTOR DATA				Nominal Diameter Over Cabled Conductor	SHIELD		JACKET	
	Equivalent AWG	Strand Construction	Nominal Wall Thickness	Nominal Diameter		AWG of Shield	Nominal Diameter Over Shield	Nominal Wall Thickness	Nominal OD
3	34	10/44	.005	.017	.037	44	.046	.010	.066
3	34	7/42	.005	.018	.039	44	.048	.010	.068
3	32	65/50	.005	.019	.041	44	.050	.010	.070
3	32	26/46	.005	.019	.041	44	.050	.010	.070
3	32	16/44	.005	.019	.041	44	.050	.010	.070
3	32	7/40	.005	.019	.041	44	.050	.010	.070
3	30	41/46	.005	.022	.047	44	.056	.010	.076
3	30	25/44	.005	.022	.047	44	.056	.010	.076
3	30	11/40	.005	.022	.047	44	.056	.010	.076
3	30	7/38	.005	.022	.047	44	.056	.010	.076
4	38	17/50	.005	.015	.036	44	.045	.010	.065
4	38	7/46	.005	.015	.036	44	.045	.010	.065
4	36	26/50	.005	.016	.039	44	.048	.010	.068
4	36	7/44	.005	.016	.039	44	.048	.010	.068
4	34	41/50	.005	.017	.041	44	.050	.010	.070
4	34	10/44	.005	.017	.041	44	.050	.010	.070
4	34	7/42	.005	.018	.043	44	.052	.010	.072
4	32	65/50	.005	.019	.046	44	.055	.010	.075
4	32	26/46	.005	.019	.046	44	.055	.010	.075
4	32	16/44	.005	.019	.046	44	.055	.010	.075
4	32	7/40	.005	.019	.046	44	.055	.010	.075
4	30	41/46	.005	.022	.053	44	.062	.010	.082
4	30	25/44	.005	.022	.053	44	.062	.010	.082
4	30	11/40	.005	.022	.053	44	.062	.010	.082
4	30	7/38	.005	.022	.053	44	.062	.010	.082
5	38	17/50	.005	.015	.041	44	.050	.010	.070
5	38	7/46	.005	.015	.041	44	.050	.010	.070
5	36	26/50	.005	.016	.043	44	.052	.010	.072
5	36	7/44	.005	.016	.043	44	.052	.010	.072
5	34	41/50	.005	.017	.046	44	.055	.010	.075
5	34	10/44	.005	.017	.046	44	.055	.010	.075
5	34	7/42	.005	.018	.049	44	.058	.010	.078
5	32	65/50	.005	.019	.051	44	.060	.010	.080
5	32	26/46	.005	.019	.051	44	.060	.010	.080
5	32	16/44	.005	.019	.051	44	.060	.010	.080
5	32	7/40	.005	.019	.051	44	.060	.010	.080
5	30	41/46	.005	.022	.060	44	.069	.010	.089
5	30	25/44	.005	.022	.060	44	.069	.010	.089
5	30	11/40	.005	.022	.060	44	.069	.010	.089
5	30	7/38	.005	.022	.060	44	.069	.010	.089

Our standard colors for primary and overall jackets include: white, black, red, green, yellow, blue, brown, orange, gray and violet. Custom color and/or exact color match available; please contact our design team for your specific requirement.

*All measurements are in inches unless otherwise stated.*

[www.newenglandwire.com](http://www.newenglandwire.com)  
Tel: 603.838.6624

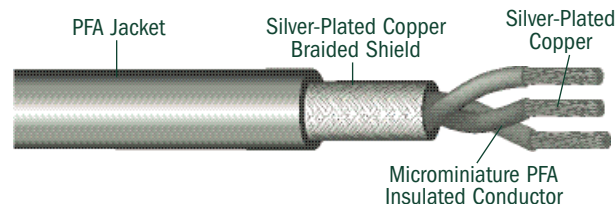

**DESCRIPTION:** Conductors are ultra flexible silver-plated copper strands insulated with 5 mil walls of color coded PFA. Extra flexible braided shields are optional over cabled conductors.

**USE:** Used when good flexibility and a high temperature are required. Please contact our design team for your specific application requirement.

Number of Conductors	SINGLE CONDUCTOR DATA				Nominal Diameter Over Cabled Conductor	SHIELD		JACKET	
	Equivalent AWG	Strand Construction	Nominal Wall Thickness	Nominal Diameter		AWG of Shield	Nominal Diameter Over Shield	Nominal Wall Thickness	Nominal OD
1	38	17/50	.005	.015	.015	44	.024	.010	.044
1	38	7/46	.005	.015	.015	44	.024	.010	.044
1	36	26/50	.005	.016	.016	44	.025	.010	.045
1	36	7/44	.005	.016	.016	44	.025	.010	.045
1	34	41/50	.005	.017	.017	44	.026	.010	.046
1	34	10/44	.005	.017	.017	44	.026	.010	.046
1	34	7/42	.005	.018	.018	44	.027	.010	.047
1	32	65/50	.005	.019	.019	44	.028	.010	.048
1	32	26/46	.005	.019	.019	44	.028	.010	.048
1	32	16/44	.005	.019	.019	44	.028	.010	.048
1	32	7/40	.005	.019	.019	44	.028	.010	.048
1	30	41/46	.005	.022	.022	44	.031	.010	.051
1	30	25/44	.005	.022	.022	44	.031	.010	.051
1	30	11/40	.005	.022	.022	44	.031	.010	.051
1	30	7/38	.005	.022	.022	44	.031	.010	.051
2	38	17/50	.005	.015	.029	44	.038	.010	.058
2	38	7/46	.005	.015	.029	44	.038	.010	.058
2	36	26/50	.005	.016	.031	44	.040	.010	.060
2	36	7/44	.005	.016	.031	44	.040	.010	.060
2	34	41/50	.005	.017	.033	44	.042	.010	.062
2	34	10/44	.005	.017	.033	44	.042	.010	.062
2	34	7/42	.005	.018	.035	44	.044	.010	.064
2	32	65/50	.005	.019	.037	44	.046	.010	.066
2	32	26/46	.005	.019	.037	44	.046	.010	.066
2	32	16/44	.005	.019	.037	44	.046	.010	.066
2	32	7/40	.005	.019	.037	44	.046	.010	.066
2	30	41/46	.005	.022	.043	44	.052	.010	.072
2	30	25/44	.005	.022	.043	44	.052	.010	.072
2	30	11/40	.005	.022	.043	44	.052	.010	.072
2	30	7/38	.005	.022	.043	44	.052	.010	.072
3	38	17/50	.005	.015	.032	44	.041	.010	.061
3	38	7/46	.005	.015	.032	44	.041	.010	.061
3	36	26/50	.005	.016	.034	44	.043	.010	.063
3	36	7/44	.005	.016	.034	44	.043	.010	.063
3	34	41/50	.005	.017	.037	44	.046	.010	.066

Our standard colors for primary and overall jackets include: white, black, red, green, yellow, blue, brown, orange, gray and violet. Custom color and/or exact color match available; please contact our design team for your specific requirement.

All measurements are in inches unless otherwise stated.

# Ultra Flexible Single & Multiconductor PFA & PFA Insulated Cables, *continued*

Number of Conductors	SINGLE CONDUCTOR DATA				Nominal Diameter Over Cabled Conductor	SHIELD		JACKET	
	Equivalent AWG	Strand Construction	Nominal Wall Thickness	Nominal Diameter		AWG of Shield	Nominal Diameter Over Shield	Nominal Wall Thickness	Nominal OD
3	34	10/44	.005	.017	.037	44	.046	.010	.066
3	34	7/42	.005	.018	.039	44	.048	.010	.068
3	32	65/50	.005	.019	.041	44	.050	.010	.070
3	32	26/46	.005	.019	.041	44	.050	.010	.070
3	32	16/44	.005	.019	.041	44	.050	.010	.070
3	32	7/40	.005	.019	.041	44	.050	.010	.070
3	30	41/46	.005	.022	.047	44	.056	.010	.076
3	30	25/44	.005	.022	.047	44	.056	.010	.076
3	30	11/40	.005	.022	.047	44	.056	.010	.076
3	30	7/38	.005	.022	.047	44	.056	.010	.076
4	38	17/50	.005	.015	.036	44	.045	.010	.065
4	38	7/46	.005	.015	.036	44	.045	.010	.065
4	36	26/50	.005	.016	.039	44	.048	.010	.068
4	36	7/44	.005	.016	.039	44	.048	.010	.068
4	34	41/50	.005	.017	.041	44	.050	.010	.070
4	34	10/44	.005	.017	.041	44	.050	.010	.070
4	34	7/42	.005	.018	.043	44	.052	.010	.072
4	32	65/50	.005	.019	.046	44	.055	.010	.075
4	32	26/46	.005	.019	.046	44	.055	.010	.075
4	32	16/44	.005	.019	.046	44	.055	.010	.075
4	32	7/40	.005	.019	.046	44	.055	.010	.075
4	30	41/46	.005	.022	.053	44	.062	.010	.082
4	30	25/44	.005	.022	.053	44	.062	.010	.082
4	30	11/40	.005	.022	.053	44	.062	.010	.082
4	30	7/38	.005	.022	.053	44	.062	.010	.082
5	38	17/50	.005	.015	.041	44	.050	.010	.070
5	38	7/46	.005	.015	.041	44	.050	.010	.070
5	36	26/50	.005	.016	.043	44	.052	.010	.072
5	36	7/44	.005	.016	.043	44	.052	.010	.072
5	34	41/50	.005	.017	.046	44	.055	.010	.075
5	34	10/44	.005	.017	.046	44	.055	.010	.075
5	34	7/42	.005	.018	.049	44	.058	.010	.078
5	32	65/50	.005	.019	.051	44	.060	.010	.080
5	32	26/46	.005	.019	.051	44	.060	.010	.080
5	32	16/44	.005	.019	.051	44	.060	.010	.080
5	32	7/40	.005	.019	.051	44	.060	.010	.080
5	30	41/46	.005	.022	.060	44	.069	.010	.089
5	30	25/44	.005	.022	.060	44	.069	.010	.089
5	30	11/40	.005	.022	.060	44	.069	.010	.089
5	30	7/38	.005	.022	.060	44	.069	.010	.089

Our standard colors for primary and overall jackets include: white, black, red, green, yellow, blue, brown, orange, gray and violet. Custom color and/or exact color match available; please contact our design team for your specific requirement.

*All measurements are in inches unless otherwise stated.*

[www.newenglandwire.com](http://www.newenglandwire.com)  
Tel: 603.838.6624

# Ultra Flexible Single & Multiconductor FEP & TPE Insulated Cables 250 Volts, 105° C



**DESCRIPTION:** Conductors are ultra flexible silver-plated copper strands insulated with a 5 mil wall of FEP with extra flexible silver-plated copper braided shield and 10 mil TPE jacket overall. Most items below are also available with tinned copper conductors and shields.

**USE:** Useful in transducers, flow probes, defibrillators, peripheral telemetry equipment and other applications where durable, flexible, multiconductor connections are required. Please contact our design team for your specific requirements.

Number of Conductors	SINGLE CONDUCTOR DATA				Nominal Diameter Over Cabled Conductor	SHIELD		JACKET	
	Equivalent AWG	Strand Construction	Nominal Wall Thickness	Nominal Diameter		AWG of Shield	Nominal Diameter Over Shield	Nominal Wall Thickness	Nominal OD
1	38	17/50	.005	.015	.015	44	.024	.010	.044
1	38	7/46	.005	.015	.015	44	.024	.010	.044
1	36	26/50	.005	.016	.016	44	.025	.010	.045
1	36	7/44	.005	.016	.016	44	.025	.010	.045
1	34	41/50	.005	.017	.017	44	.026	.010	.046
1	34	10/44	.005	.017	.017	44	.026	.010	.046
1	34	7/42	.005	.018	.018	44	.027	.010	.047
1	32	65/50	.005	.019	.019	44	.028	.010	.048
1	32	26/46	.005	.019	.019	44	.028	.010	.048
1	32	16/44	.005	.019	.019	44	.028	.010	.048
1	32	7/40	.005	.019	.019	44	.028	.010	.048
1	30	41/46	.005	.022	.022	44	.031	.010	.051
1	30	25/44	.005	.022	.022	44	.031	.010	.051
1	30	11/40	.005	.022	.022	44	.031	.010	.051
1	30	7/38	.005	.022	.022	44	.031	.010	.051
2	38	17/50	.005	.015	.029	44	.038	.010	.058
2	38	7/46	.005	.015	.029	44	.038	.010	.058
2	36	26/50	.005	.016	.031	44	.040	.010	.060
2	36	7/44	.005	.016	.031	44	.040	.010	.060
2	34	41/50	.005	.017	.033	44	.042	.010	.062
2	34	10/44	.005	.017	.033	44	.042	.010	.062
2	34	7/42	.005	.018	.035	44	.044	.010	.064
2	32	65/50	.005	.019	.037	44	.046	.010	.066
2	32	26/46	.005	.019	.037	44	.046	.010	.066
2	32	16/44	.005	.019	.037	44	.046	.010	.066
2	32	7/40	.005	.019	.037	44	.046	.010	.066
2	30	41/46	.005	.022	.043	44	.052	.010	.072
2	30	25/44	.005	.022	.043	44	.052	.010	.072
2	30	11/40	.005	.022	.043	44	.052	.010	.072
2	30	7/38	.005	.022	.043	44	.052	.010	.072
3	38	17/50	.005	.015	.032	44	.041	.010	.061
3	38	7/46	.005	.015	.032	44	.041	.010	.061
3	36	26/50	.005	.016	.034	44	.043	.010	.063
3	36	7/44	.005	.016	.034	44	.043	.010	.063
3	34	41/50	.005	.017	.037	44	.046	.010	.066

Our standard colors for primary and overall jackets include: white, black, red, green, yellow, blue, brown, orange, gray and violet. Custom color and/or exact color match available; please contact our design team for your specific requirement.

All measurements are in inches unless otherwise stated.



# Ultra Flexible Single & Multiconductor FEP & TPE Insulated Cables, *continued*

Number of Conductors	SINGLE CONDUCTOR DATA				Nominal Diameter Over Cabled Conductor	SHIELD		JACKET	
	Equivalent AWG	Strand Construction	Nominal Wall Thickness	Nominal Diameter		AWG of Shield	Nominal Diameter Over Shield	Nominal Wall Thickness	Nominal OD
3	34	10/44	.005	.017	.037	44	.046	.010	.066
3	34	7/42	.005	.018	.039	44	.048	.010	.068
3	32	65/50	.005	.019	.041	44	.050	.010	.070
3	32	26/46	.005	.019	.041	44	.050	.010	.070
3	32	16/44	.005	.019	.041	44	.050	.010	.070
3	32	7/40	.005	.019	.041	44	.050	.010	.070
3	30	41/46	.005	.022	.047	44	.056	.010	.076
3	30	25/44	.005	.022	.047	44	.056	.010	.076
3	30	11/40	.005	.022	.047	44	.056	.010	.076
3	30	7/38	.005	.022	.047	44	.056	.010	.076
4	38	17/50	.005	.015	.036	44	.045	.010	.065
4	38	7/46	.005	.015	.036	44	.045	.010	.065
4	36	26/50	.005	.016	.039	44	.048	.010	.068
4	36	7/44	.005	.016	.039	44	.048	.010	.068
4	34	41/50	.005	.017	.041	44	.050	.010	.070
4	34	10/44	.005	.017	.041	44	.050	.010	.070
4	34	7/42	.005	.018	.043	44	.052	.010	.072
4	32	65/50	.005	.019	.046	44	.055	.010	.075
4	32	26/46	.005	.019	.046	44	.055	.010	.075
4	32	16/44	.005	.019	.046	44	.055	.010	.075
4	32	7/40	.005	.019	.046	44	.055	.010	.075
4	30	41/46	.005	.022	.053	44	.062	.010	.082
4	30	25/44	.005	.022	.053	44	.062	.010	.082
4	30	11/40	.005	.022	.053	44	.062	.010	.082
4	30	7/38	.005	.022	.053	44	.062	.010	.082
5	38	17/50	.005	.015	.041	44	.050	.010	.070
5	38	7/46	.005	.015	.041	44	.050	.010	.070
5	36	26/50	.005	.016	.043	44	.052	.010	.072
5	36	7/44	.005	.016	.043	44	.052	.010	.072
5	34	41/50	.005	.017	.046	44	.055	.010	.075
5	34	10/44	.005	.017	.046	44	.055	.010	.075
5	34	7/42	.005	.018	.049	44	.058	.010	.078
5	32	65/50	.005	.019	.051	44	.060	.010	.080
5	32	26/46	.005	.019	.051	44	.060	.010	.080
5	32	16/44	.005	.019	.051	44	.060	.010	.080
5	32	7/40	.005	.019	.051	44	.060	.010	.080
5	30	41/46	.005	.022	.060	44	.069	.010	.089
5	30	25/44	.005	.022	.060	44	.069	.010	.089
5	30	11/40	.005	.022	.060	44	.069	.010	.089
5	30	7/38	.005	.022	.060	44	.069	.010	.089

Our standard colors for primary and overall jackets include: white, black, red, green, yellow, blue, brown, orange, gray and violet. Custom color and/or exact color match available; please contact our design team for your specific requirement.

*All measurements are in inches unless otherwise stated.*

[www.newenglandwire.com](http://www.newenglandwire.com)  
Tel: 603.838.6624

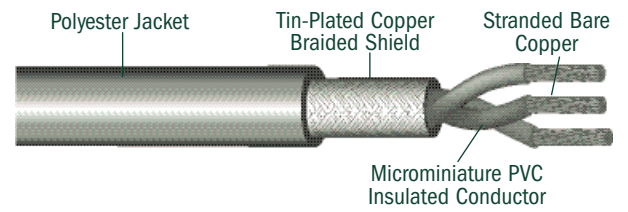

**DESCRIPTION:** Conductors are ultra flexible bare copper strands insulated with 5 mil walls of PVC. Extra flexible braided shields, jackets or both can be applied over the cabled conductors. Most of the items below are also available with tinned copper stranded conductors and tinned copper braided shields.

**USE:** For use in applications requiring good flexibility, high temperature, abrasion and oil resistance. Please contact our design team for your specific application.

Number of Conductors	SINGLE CONDUCTOR DATA				Nominal Diameter Over Cabled Conductor	SHIELD		JACKET	
	Equivalent AWG	Strand Construction	Nominal Wall Thickness	Nominal Diameter		AWG of Shield	Nominal Diameter Over Shield	Nominal Wall Thickness	Nominal OD
1	38	17/50	.005	.015	.015	44	.024	.010	.044
1	38	7/46	.005	.015	.015	44	.024	.010	.044
1	36	26/50	.005	.016	.016	44	.025	.010	.045
1	36	7/44	.005	.016	.016	44	.025	.010	.045
1	34	41/50	.005	.017	.017	44	.026	.010	.046
1	34	10/44	.005	.017	.017	44	.026	.010	.046
1	34	7/42	.005	.018	.018	44	.027	.010	.047
1	32	65/50	.005	.019	.019	44	.028	.010	.048
1	32	26/46	.005	.019	.019	44	.028	.010	.048
1	32	16/44	.005	.019	.019	44	.028	.010	.048
1	32	7/40	.005	.019	.019	44	.028	.010	.048
1	30	41/46	.005	.022	.022	44	.031	.010	.051
1	30	25/44	.005	.022	.022	44	.031	.010	.051
1	30	11/40	.005	.022	.022	44	.031	.010	.051
1	30	7/38	.005	.022	.022	44	.031	.010	.051
2	38	17/50	.005	.015	.029	44	.038	.010	.058
2	38	7/46	.005	.015	.029	44	.038	.010	.058
2	36	26/50	.005	.016	.031	44	.040	.010	.060
2	36	7/44	.005	.016	.031	44	.040	.010	.060
2	34	41/50	.005	.017	.033	44	.042	.010	.062
2	34	10/44	.005	.017	.033	44	.042	.010	.062
2	34	7/42	.005	.018	.035	44	.044	.010	.064
2	32	65/50	.005	.019	.037	44	.046	.010	.066
2	32	26/46	.005	.019	.037	44	.046	.010	.066
2	32	16/44	.005	.019	.037	44	.046	.010	.066
2	32	7/40	.005	.019	.037	44	.046	.010	.066
2	30	41/46	.005	.022	.043	44	.052	.010	.072
2	30	25/44	.005	.022	.043	44	.052	.010	.072
2	30	11/40	.005	.022	.043	44	.052	.010	.072
2	30	7/38	.005	.022	.043	44	.052	.010	.072
3	38	17/50	.005	.015	.032	44	.041	.010	.061
3	38	7/46	.005	.015	.032	44	.041	.010	.061
3	36	26/50	.005	.016	.034	44	.043	.010	.063
3	36	7/44	.005	.016	.034	44	.043	.010	.063
3	34	41/50	.005	.017	.037	44	.046	.010	.066

Our standard colors for primary and overall jackets include: white, black, red, green, yellow, blue, brown, orange, gray and violet. Custom color and/or exact color match available; please contact our design team for your specific requirement.

All measurements are in inches unless otherwise stated.

# Ultra Flexible Single & Multiconductor PVC & Polyester Insulated Cables, *continued*

Number of Conductors	SINGLE CONDUCTOR DATA				Nominal Diameter Over Cabled Conductor	SHIELD		JACKET	
	Equivalent AWG	Strand Construction	Nominal Wall Thickness	Nominal Diameter		AWG of Shield	Nominal Diameter Over Shield	Nominal Wall Thickness	Nominal OD
3	34	10/44	.005	.017	.037	44	.046	.010	.066
3	34	7/42	.005	.018	.039	44	.048	.010	.068
3	32	65/50	.005	.019	.041	44	.050	.010	.070
3	32	26/46	.005	.019	.041	44	.050	.010	.070
3	32	16/44	.005	.019	.041	44	.050	.010	.070
3	32	7/40	.005	.019	.041	44	.050	.010	.070
3	30	41/46	.005	.022	.047	44	.056	.010	.076
3	30	25/44	.005	.022	.047	44	.056	.010	.076
3	30	11/40	.005	.022	.047	44	.056	.010	.076
3	30	7/38	.005	.022	.047	44	.056	.010	.076
4	38	17/50	.005	.015	.036	44	.045	.010	.065
4	38	7/46	.005	.015	.036	44	.045	.010	.065
4	36	26/50	.005	.016	.039	44	.048	.010	.068
4	36	7/44	.005	.016	.039	44	.048	.010	.068
4	34	41/50	.005	.017	.041	44	.050	.010	.070
4	34	10/44	.005	.017	.041	44	.050	.010	.070
4	34	7/42	.005	.018	.043	44	.052	.010	.072
4	32	65/50	.005	.019	.046	44	.055	.010	.075
4	32	26/46	.005	.019	.046	44	.055	.010	.075
4	32	16/44	.005	.019	.046	44	.055	.010	.075
4	32	7/40	.005	.019	.046	44	.055	.010	.075
4	30	41/46	.005	.022	.053	44	.062	.010	.082
4	30	25/44	.005	.022	.053	44	.062	.010	.082
4	30	11/40	.005	.022	.053	44	.062	.010	.082
4	30	7/38	.005	.022	.053	44	.062	.010	.082
5	38	17/50	.005	.015	.041	44	.050	.010	.070
5	38	7/46	.005	.015	.041	44	.050	.010	.070
5	36	26/50	.005	.016	.043	44	.052	.010	.072
5	36	7/44	.005	.016	.043	44	.052	.010	.072
5	34	41/50	.005	.017	.046	44	.055	.010	.075
5	34	10/44	.005	.017	.046	44	.055	.010	.075
5	34	7/42	.005	.018	.049	44	.058	.010	.078
5	32	65/50	.005	.019	.051	44	.060	.010	.080
5	32	26/46	.005	.019	.051	44	.060	.010	.080
5	32	16/44	.005	.019	.051	44	.060	.010	.080
5	32	7/40	.005	.019	.051	44	.060	.010	.080
5	30	41/46	.005	.022	.060	44	.069	.010	.089
5	30	25/44	.005	.022	.060	44	.069	.010	.089
5	30	11/40	.005	.022	.060	44	.069	.010	.089
5	30	7/38	.005	.022	.060	44	.069	.010	.089

Our standard colors for primary and overall jackets include: white, black, red, green, yellow, blue, brown, orange, gray and violet. Custom color and/or exact color match available; please contact our design team for your specific requirement.

[www.newenglandwire.com](http://www.newenglandwire.com)

Tel: 603.838.6624

# Ultra Flexible Single & Multiconductor PVC & TPE Insulated Cables 200 Volts, 105° C

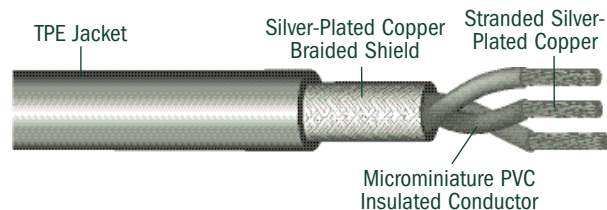

**DESCRIPTION:** Conductors are ultra flexible silver-plated copper strands insulated with a 5 mil wall of PVC, an extra flexible silver-plated copper braided shield, and 10 mil wall TPE jacket overall.

**USE:** Low voltage applications which require small size and good flexibility. Please call our design team to discuss your specific application requirements.

Number of Conductors	SINGLE CONDUCTOR DATA				Nominal Diameter Over Cabled Conductor	SHIELD		JACKET	
	Equivalent AWG	Strand Construction	Nominal Wall Thickness	Nominal Diameter		AWG of Shield	Nominal Diameter Over Shield	Nominal Wall Thickness	Nominal OD
1	38	17/50	.005	.015	.015	44	.024	.010	.044
1	38	7/46	.005	.015	.015	44	.024	.010	.044
1	36	26/50	.005	.016	.016	44	.025	.010	.045
1	36	7/44	.005	.016	.016	44	.025	.010	.045
1	34	41/50	.005	.017	.017	44	.026	.010	.046
1	34	10/44	.005	.017	.017	44	.026	.010	.046
1	34	7/42	.005	.018	.018	44	.027	.010	.047
1	32	65/50	.005	.019	.019	44	.028	.010	.048
1	32	26/46	.005	.019	.019	44	.028	.010	.048
1	32	16/44	.005	.019	.019	44	.028	.010	.048
1	32	7/40	.005	.019	.019	44	.028	.010	.048
1	30	41/46	.005	.022	.022	44	.031	.010	.051
1	30	25/44	.005	.022	.022	44	.031	.010	.051
1	30	11/40	.005	.022	.022	44	.031	.010	.051
1	30	7/38	.005	.022	.022	44	.031	.010	.051
2	38	17/50	.005	.015	.029	44	.038	.010	.058
2	38	7/46	.005	.015	.029	44	.038	.010	.058
2	36	26/50	.005	.016	.031	44	.040	.010	.060
2	36	7/44	.005	.016	.031	44	.040	.010	.060
2	34	41/50	.005	.017	.033	44	.042	.010	.062
2	34	10/44	.005	.017	.033	44	.042	.010	.062
2	34	7/42	.005	.018	.035	44	.044	.010	.064
2	32	65/50	.005	.019	.037	44	.046	.010	.066
2	32	26/46	.005	.019	.037	44	.046	.010	.066
2	32	16/44	.005	.019	.037	44	.046	.010	.066
2	32	7/40	.005	.019	.037	44	.046	.010	.066
2	30	41/46	.005	.022	.043	44	.052	.010	.072
2	30	25/44	.005	.022	.043	44	.052	.010	.072
2	30	11/40	.005	.022	.043	44	.052	.010	.072
2	30	7/38	.005	.022	.043	44	.052	.010	.072
3	38	17/50	.005	.015	.032	44	.041	.010	.061
3	38	7/46	.005	.015	.032	44	.041	.010	.061
3	36	26/50	.005	.016	.034	44	.043	.010	.063
3	36	7/44	.005	.016	.034	44	.043	.010	.063
3	34	41/50	.005	.017	.037	44	.046	.010	.066

Our standard colors for primary and overall jackets include: white, black, red, green, yellow, blue, brown, orange, gray and violet. Custom color and/or exact color match available; please contact our design team for your specific requirement.

All measurements are in inches unless otherwise stated.



NEW ENGLAND WIRE TECHNOLOGIES  
Innovate. Create. Accelerate.



# Ultra Flexible Single & Multiconductor PVC & TPE Insulated Cables, *continued*

Number of Conductors	SINGLE CONDUCTOR DATA				Nominal Diameter Over Cabled Conductor	SHIELD		JACKET	
	Equivalent AWG	Strand Construction	Nominal Wall Thickness	Nominal Diameter		AWG of Shield	Nominal Diameter Over Shield	Nominal Wall Thickness	Nominal OD
3	34	10/44	.005	.017	.037	44	.046	.010	.066
3	34	7/42	.005	.018	.039	44	.048	.010	.068
3	32	65/50	.005	.019	.041	44	.050	.010	.070
3	32	26/46	.005	.019	.041	44	.050	.010	.070
3	32	16/44	.005	.019	.041	44	.050	.010	.070
3	32	7/40	.005	.019	.041	44	.050	.010	.070
3	30	41/46	.005	.022	.047	44	.056	.010	.076
3	30	25/44	.005	.022	.047	44	.056	.010	.076
3	30	11/40	.005	.022	.047	44	.056	.010	.076
3	30	7/38	.005	.022	.047	44	.056	.010	.076
4	38	17/50	.005	.015	.036	44	.045	.010	.065
4	38	7/46	.005	.015	.036	44	.045	.010	.065
4	36	26/50	.005	.016	.039	44	.048	.010	.068
4	36	7/44	.005	.016	.039	44	.048	.010	.068
4	34	41/50	.005	.017	.041	44	.050	.010	.070
4	34	10/44	.005	.017	.041	44	.050	.010	.070
4	34	7/42	.005	.018	.043	44	.052	.010	.072
4	32	65/50	.005	.019	.046	44	.055	.010	.075
4	32	26/46	.005	.019	.046	44	.055	.010	.075
4	32	16/44	.005	.019	.046	44	.055	.010	.075
4	32	7/40	.005	.019	.046	44	.055	.010	.075
4	30	41/46	.005	.022	.053	44	.062	.010	.082
4	30	25/44	.005	.022	.053	44	.062	.010	.082
4	30	11/40	.005	.022	.053	44	.062	.010	.082
4	30	7/38	.005	.022	.053	44	.062	.010	.082
5	38	17/50	.005	.015	.041	44	.050	.010	.070
5	38	7/46	.005	.015	.041	44	.050	.010	.070
5	36	26/50	.005	.016	.043	44	.052	.010	.072
5	36	7/44	.005	.016	.043	44	.052	.010	.072
5	34	41/50	.005	.017	.046	44	.055	.010	.075
5	34	10/44	.005	.017	.046	44	.055	.010	.075
5	34	7/42	.005	.018	.049	44	.058	.010	.078
5	32	65/50	.005	.019	.051	44	.060	.010	.080
5	32	26/46	.005	.019	.051	44	.060	.010	.080
5	32	16/44	.005	.019	.051	44	.060	.010	.080
5	32	7/40	.005	.019	.051	44	.060	.010	.080
5	30	41/46	.005	.022	.060	44	.069	.010	.089
5	30	25/44	.005	.022	.060	44	.069	.010	.089
5	30	11/40	.005	.022	.060	44	.069	.010	.089
5	30	7/38	.005	.022	.060	44	.069	.010	.089

Our standard colors for primary and overall jackets include: white, black, red, green, yellow, blue, brown, orange, gray and violet. Custom color and/or exact color match available; please contact our design team for your specific requirement.

*All measurements are in inches unless otherwise stated.*

[www.newenglandwire.com](http://www.newenglandwire.com)  
Tel: 603.838.6624

# Extra Flexible Single & Multiconductor PVC & Polyurethane Insulated Cables 600 Volts, 80° C

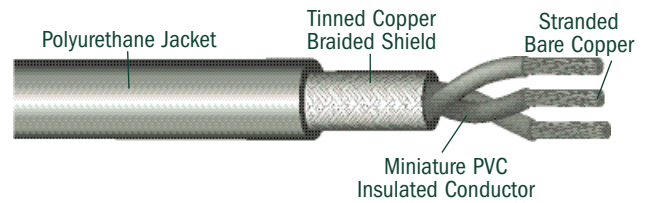

**DESCRIPTION:** Conductors are extra flexible bare copper strands insulated with 10 mil walls of PVC. Extra flexible, tinned copper braided shields, Polyurethane jackets or both can be applied over the cabled conductors. For special applications, spiral shield can be substituted for braided shields.

**USE:** Industrial applications requiring miniature, extra flexible multi-conductor connections. Please contact our design team for your specific application.

Number of Conductors	SINGLE CONDUCTOR DATA				Nominal Diameter Over Cabled Conductor	SHIELD		JACKET	
	Equivalent AWG	Strand Construction	Nominal Wall Thickness	Nominal Diameter		AWG of Shield	Nominal Diameter Over Shield	Nominal Wall Thickness	Nominal OD
1	34	16/46	.010	.027	.027	44	.036	.010	.056
1	34	10/44	.010	.027	.027	44	.036	.010	.056
1	34	5/40	.010	.028	.028	44	.037	.010	.057
1	32	26/46	.010	.029	.029	44	.038	.010	.058
1	32	16/44	.010	.029	.029	44	.038	.010	.058
1	32	7/40	.010	.029	.026	44	.038	.010	.058
1	30	41/46	.010	.032	.032	44	.041	.010	.061
1	30	25/44	.010	.032	.032	44	.041	.010	.061
1	30	7/38	.010	.032	.032	44	.041	.010	.061
1	29	52/46	.010	.033	.033	44	.042	.010	.062
1	28	65/46	.010	.035	.035	44	.044	.010	.064
1	28	40/44	.010	.035	.035	44	.044	.010	.064
1	28	19/40	.010	.035	.035	44	.044	.010	.064
1	26	26/40	.010	.038	.038	40	.052	.010	.072
1	26	66/44	.010	.039	.039	40	.059	.010	.079
1	26	19/38	.010	.039	.039	40	.059	.010	.073
1	24	3x35/44	.010	.045	.045	40	.059	.010	.079
1	24	42/40	.010	.043	.043	40	.057	.010	.077
1	24	19/36	.010	.044	.044	40	.058	.010	.078
1	23	3x50/44	.010	.050	.050	40	.064	.010	.084
1	22	66/40	.010	.049	.049	40	.063	.010	.083
1	22	26/36	.010	.049	.049	40	.063	.010	.083
1	20	7x37/44	.010	.060	.060	40	.074	.010	.094
1	20	7x15/40	.010	.059	.059	40	.073	.010	.093
1	20	42/36	.010	.057	.057	40	.071	.010	.091
1	18	7x59/44	.010	.070	.070	40	.084	.010	.104
1	18	7x24/40	.010	.070	.070	40	.084	.010	.104
2	34	16/46	.010	.027	.053	44	.062	.010	.082
2	34	10/44	.010	.027	.053	44	.062	.010	.082
2	34	5/40	.010	.028	.055	44	.064	.010	.084
2	32	26/46	.010	.029	.057	44	.066	.010	.086
2	32	16/44	.010	.029	.057	44	.066	.010	.086
2	32	7/40	.010	.029	.057	44	.066	.010	.086
2	30	41/46	.010	.032	.063	44	.072	.010	.092
2	30	25/44	.010	.032	.063	44	.072	.010	.092
2	30	7/38	.010	.032	.063	44	.072	.010	.092
2	29	52/46	.010	.033	.065	44	.074	.010	.094
2	28	65/46	.010	.035	.069	40	.083	.010	.103
2	28	40/44	.010	.035	.069	40	.083	.010	.103

Our standard colors for primary and overall jackets include: white, black, red, green, yellow, blue, brown, orange, gray and violet. Custom color and/or exact color match available; please contact our design team for your specific requirement.

All measurements are in inches unless otherwise stated.



# Extra Flexible Single & Multiconductor PVC & Polyurethane Insulated Cables, *continued*

Number of Conductors	SINGLE CONDUCTOR DATA				Nominal Diameter Over Cabled Conductor	SHIELD		JACKET	
	Equivalent AWG	Strand Construction	Nominal Wall Thickness	Nominal Diameter		AWG of Shield	Nominal Diameter Over Shield	Nominal Wall Thickness	Nominal OD
2	28	19/40	.010	.035	.069	40	.083	.010	.103
2	26	26/40	.010	.038	.074	40	.088	.010	.108
2	26	66/44	.010	.039	.076	40	.090	.010	.110
2	26	19/38	.010	.039	.076	40	.090	.010	.110
2	24	3x35/44	.010	.045	.088	40	.102	.010	.122
2	24	42/40	.010	.043	.084	40	.098	.010	.118
2	24	19/36	.010	.044	.086	40	.100	.010	.120
2	23	3x50/44	.010	.050	.098	36	.121	.010	.141
2	22	66/40	.010	.049	.096	36	.119	.010	.139
2	22	26/36	.010	.049	.096	36	.119	.010	.139
2	20	7x37/44	.010	.060	.118	36	.141	.010	.161
2	20	7x15/40	.010	.059	.116	36	.139	.010	.159
2	20	42/36	.010	.057	.112	36	.135	.010	.155
2	18	7x59/44	.010	.070	.137	36	.160	.010	.180
2	18	7x24/40	.010	.070	.137	36	.160	.010	.180
3	34	16/46	.010	.027	.058	44	.067	.010	.087
3	34	10/44	.010	.027	.058	44	.067	.010	.087
3	34	5/40	.010	.028	.060	44	.069	.010	.089
3	32	26/46	.010	.029	.062	44	.071	.010	.091
3	32	16/44	.010	.029	.062	44	.071	.010	.091
3	32	7/40	.010	.029	.062	44	.071	.010	.091
3	30	41/46	.010	.032	.069	44	.078	.010	.098
3	30	25/44	.010	.032	.069	44	.078	.010	.098
3	30	7/38	.010	.032	.069	44	.078	.010	.098
3	29	52/46	.010	.033	.071	40	.085	.010	.105
3	28	65/46	.010	.035	.075	40	.089	.010	.109
3	28	40/44	.010	.035	.075	40	.089	.010	.109
3	28	19/40	.010	.035	.075	40	.089	.010	.109
3	26	26/40	.010	.038	.082	40	.096	.010	.116
3	26	66/44	.010	.039	.084	40	.098	.010	.118
3	26	19/38	.010	.039	.084	40	.098	.010	.118
3	24	3x35/44	.010	.045	.097	36	.120	.010	.140
3	24	42/40	.010	.043	.092	36	.115	.010	.135
3	24	19/36	.010	.044	.095	36	.118	.010	.138
3	23	3x50/44	.010	.050	.108	36	.131	.010	.151
3	22	66/40	.010	.049	.105	36	.128	.010	.148
3	22	26/36	.010	.049	.105	36	.128	.010	.148
3	20	7x37/44	.010	.060	.129	36	.152	.010	.172
3	20	7x15/40	.010	.059	.127	36	.150	.010	.170
3	20	42/36	.010	.057	.123	36	.146	.010	.166
3	18	7x59/44	.010	.070	.151	36	.174	.010	.194
3	18	7x24/40	.010	.070	.151	36	.174	.010	.194
4	34	16/46	.010	.027	.065	44	.074	.010	.094
4	34	10/44	.010	.027	.065	44	.074	.010	.094
4	34	5/40	.010	.028	.067	44	.076	.010	.096
4	32	26/46	.010	.029	.070	44	.079	.010	.099
4	32	16/44	.010	.029	.070	44	.079	.010	.099
4	32	7/40	.010	.029	.070	44	.079	.010	.099

Our standard colors for primary and overall jackets include: white, black, red, green, yellow, blue, brown, orange, gray and violet. Custom color and/or exact color match available; please contact our design team for your specific requirement.

*All measurements are in inches unless otherwise stated.*

**www.newenglandwire.com**  
**Tel: 603.838.6624**

# Extra Flexible Single & Multiconductor PVC & Polyurethane Insulated Cables, *continued*

Number of Conductors	SINGLE CONDUCTOR DATA				Nominal Diameter Over Cabled Conductor	SHIELD		JACKET	
	Equivalent AWG	Strand Construction	Nominal Wall Thickness	Nominal Diameter		AWG of Shield	Nominal Diameter Over Shield	Nominal Wall Thickness	Nominal OD
4	30	41/46	.010	.032	.077	44	.086	.010	.106
4	30	25/44	.010	.032	.077	44	.086	.010	.106
4	30	7/38	.010	.032	.077	44	.086	.010	.106
4	29	52/46	.010	.033	.080	40	.094	.010	.114
4	28	65/46	.010	.035	.084	40	.098	.010	.118
4	28	40/44	.010	.035	.084	40	.098	.010	.118
4	28	19/40	.010	.035	.084	40	.098	.010	.118
4	26	26/40	.010	.038	.092	40	.106	.010	.126
4	26	66/44	.010	.039	.094	40	.108	.010	.128
4	26	19/38	.010	.039	.094	40	.108	.010	.128
4	24	3x35/44	.010	.045	.108	36	.131	.010	.151
4	24	42/40	.010	.043	.104	36	.127	.010	.147
4	24	19/36	.010	.044	.106	36	.129	.010	.149
4	23	3x50/44	.010	.050	.121	36	.144	.010	.164
4	22	66/40	.010	.049	.118	36	.141	.010	.161
4	22	26/36	.010	.049	.118	36	.141	.010	.151
4	20	7x37/44	.010	.060	.145	36	.168	.010	.188
4	20	7x15/40	.010	.059	.142	36	.165	.010	.185
4	18	42/36	.010	.057	.137	36	.160	.010	.180
4	18	7x59/44	.010	.070	.169	36	.192	.010	.212
4	18	7x24/40	.010	.070	.169	36	.192	.010	.212
5	34	16/46	.010	.027	.073	44	.082	.010	.102
5	34	10/44	.010	.027	.073	44	.082	.010	.102
5	32	5/40	.010	.028	.076	44	.085	.010	.105
5	32	26/46	.010	.029	.079	44	.088	.010	.108
5	32	16/44	.010	.029	.079	44	.088	.010	.108
5	30	7/40	.010	.029	.079	44	.088	.010	.108
5	30	41/46	.010	.032	.087	40	.096	.010	.116
5	30	25/44	.010	.032	.087	40	.096	.010	.116
5	29	7/38	.010	.032	.087	40	.096	.010	.116
5	28	52/46	.010	.033	.089	40	.103	.010	.123
5	28	65/46	.010	.035	.095	40	.109	.010	.129
5	28	40/44	.010	.035	.095	40	.109	.010	.129
5	26	19/40	.010	.035	.095	40	.109	.010	.129
5	26	26/40	.010	.038	.103	40	.117	.010	.137
5	26	66/44	.010	.039	.106	40	.120	.010	.140
5	24	19/38	.010	.039	.106	40	.120	.010	.140
5	24	3x35/44	.010	.045	.122	36	.145	.010	.165
5	24	42/40	.010	.043	.117	36	.140	.010	.160
5	22	19/36	.010	.044	.119	36	.142	.010	.162
5	22	3x50/44	.010	.050	.136	36	.159	.010	.179
5	22	66/40	.010	.049	.133	36	.156	.010	.176
5	20	26/36	.010	.049	.133	36	.156	.010	.176
5	20	7x37/44	.010	.060	.163	36	.186	.010	.206
5	20	7x15/40	.010	.059	.160	36	.183	.010	.203
5	18	42/36	.010	.057	.154	36	.177	.010	.197
5	18	7x59/44	.010	.070	.190	36	.213	.010	.233
5	18	7x24/40	.010	.070	.190	36	.213	.010	.233

Our standard colors for primary and overall jackets include: white, black, red, green, yellow, blue, brown, orange, gray and violet. Custom color and/or exact color match available; please contact our design team for your specific requirement.

All measurements are in inches unless otherwise stated.



NEW ENGLAND WIRE TECHNOLOGIES  
Innovate. Create. Accelerate.

# Flexible Single & Multiconductor PVC & PVC Insulated Cables 600 Volts, 105° C

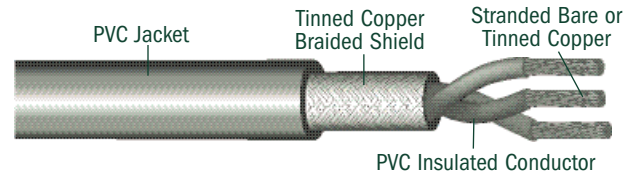

**DESCRIPTION:** Conductors are bare or tin-plated copper strands insulated with 10 mil wall of color coded PVC. Braided shields, jackets or both can be applied over the cabled conductors prior to jacketing with PVC. For special applications, spiral shields can be substituted for braided shields.

**USE:** For applications requiring good flexibility with a 600 volt rating. Please contact our design team for your specific application.

Number of Conductors	SINGLE CONDUCTOR DATA				Nominal Diameter Over Cabled Conductor	SHIELD		JACKET	
	Equivalent AWG	Strand Construction	Nominal Wall Thickness	Nominal Diameter		AWG of Shield	Nominal Diameter Over Shield	Nominal Wall Thickness	Nominal OD
1	36	7/44	.010	.026	.026	40	.040	.010	.060
1	34	10/44	.010	.027	.027	40	.041	.010	.061
1	34	7/42	.010	.028	.028	40	.042	.010	.062
1	32	7/40	.010	.029	.029	40	.043	.010	.063
1	32	19/44	.010	.030	.030	40	.044	.010	.064
1	30	11/40	.010	.032	.032	40	.046	.010	.066
1	30	7/38	.010	.032	.032	40	.046	.010	.066
1	28	19/40	.010	.035	.035	40	.049	.010	.069
1	28	7/36	.010	.035	.035	40	.049	.010	.069
1	26	26/40	.010	.038	.038	40	.052	.010	.072
1	26	19/38	.010	.039	.039	40	.053	.010	.073
1	24	42/40	.010	.043	.043	40	.057	.010	.077
1	24	19/36	.010	.044	.044	40	.058	.010	.078
2	36	7/44	.010	.026	.051	40	.065	.010	.085
2	34	10/44	.010	.027	.053	40	.067	.010	.087
2	34	7/42	.010	.028	.055	40	.069	.010	.089
2	32	7/40	.010	.029	.057	40	.071	.010	.091
2	32	19/44	.010	.030	.059	40	.073	.010	.093
2	30	11/40	.010	.032	.063	40	.077	.010	.097
2	30	7/38	.010	.032	.063	40	.077	.010	.097
2	28	19/40	.010	.035	.069	40	.083	.010	.103
2	28	7/36	.010	.035	.069	40	.083	.010	.103
2	26	26/40	.010	.038	.074	40	.088	.010	.108
2	26	19/38	.010	.039	.076	40	.090	.010	.110
2	24	42/40	.010	.043	.084	40	.098	.010	.118
2	24	19/36	.010	.044	.086	40	.100	.010	.120
3	36	7/44	.010	.026	.056	40	.070	.010	.090
3	34	10/44	.010	.027	.058	40	.072	.010	.092
3	34	7/42	.010	.028	.060	40	.074	.010	.094
3	32	7/40	.010	.029	.062	40	.076	.010	.096
3	32	19/44	.010	.030	.065	40	.079	.010	.099
3	30	11/40	.010	.032	.069	40	.083	.010	.103
3	30	7/38	.010	.032	.069	40	.083	.010	.103
3	28	19/40	.010	.035	.075	40	.089	.010	.109
3	28	7/36	.010	.035	.075	40	.089	.010	.109
3	26	26/40	.010	.038	.082	40	.096	.010	.116
3	26	19/38	.010	.039	.084	40	.098	.010	.118
3	24	42/40	.010	.043	.092	40	.106	.015	.136
3	24	19/36	.010	.044	.095	40	.109	.015	.139

Our standard colors for primary and overall jackets include: white, black, red, green, yellow, blue, brown, orange, gray and violet. Custom color and/or exact color match available; please contact our design team for your specific requirement.

All measurements are in inches unless otherwise stated.

[www.newenglandwire.com](http://www.newenglandwire.com)  
Tel: 603.838.6624

# Single and Multiconductor Cables PVC & PVC Insulated, *continued*

Number of Conductors	SINGLE CONDUCTOR DATA				Nominal Diameter Over Cabled Conductor	SHIELD		JACKET	
	Equivalent AWG	Strand Construction	Nominal Wall Thickness	Nominal Diameter		AWG of Shield	Nominal Diameter Over Shield	Nominal Wall Thickness	Nominal OD
4	36	7/44	.010	.026	.063	40	.077	.010	.097
4	34	10/44	.010	.027	.067	40	.079	.010	.099
4	34	7/42	.010	.028	.065	40	.081	.010	.101
4	32	7/40	.010	.029	.070	40	.084	.010	.104
4	32	19/44	.010	.030	.072	40	.086	.010	.106
4	30	11/40	.010	.032	.077	40	.091	.010	.111
4	30	7/38	.010	.032	.077	40	.091	.010	.111
4	28	19/40	.010	.035	.084	40	.098	.010	.118
4	28	7/36	.010	.035	.084	40	.098	.010	.118
4	26	26/40	.010	.038	.092	40	.106	.015	.136
4	26	19/38	.010	.039	.094	40	.108	.015	.138
4	24	42/40	.010	.043	.104	40	.118	.015	.148
4	24	19/36	.010	.044	.106	40	.120	.015	.150
5	36	7/44	.010	.026	.070	40	.084	.010	.104
5	34	10/44	.010	.027	.073	40	.087	.010	.107
5	34	7/42	.010	.028	.076	40	.090	.010	.110
5	32	7/40	.010	.029	.079	40	.093	.010	.113
5	32	19/44	.010	.030	.081	40	.095	.010	.115
5	30	11/40	.010	.032	.087	40	.101	.015	.131
5	30	7/38	.010	.032	.087	40	.101	.015	.131
5	28	19/40	.010	.035	.095	40	.109	.015	.139
5	28	7/36	.010	.035	.095	40	.109	.015	.139
5	26	26/40	.010	.039	.103	40	.117	.015	.147
5	26	19/38	.010	.038	.106	40	.120	.015	.150
5	24	42/40	.010	.043	.117	40	.131	.015	.161
5	24	19/36	.010	.044	.119	40	.133	.015	.163

Our standard colors for primary and overall jackets include: white, black, red, green, yellow, blue, brown, orange, gray and violet. Custom color and/or exact color match available; please contact our design team for your specific requirement.

*All measurements are in inches unless otherwise stated.*





## COMMUNICATION & CONTROL CABLES

New England Wire Technologies has been supplying custom cable products to the communications industry since 1898 when we sought out and purchased a design for a new type of machinery to wrap insulated threads of silk or cotton around fine copper wire. This wire was one of the key components of the early telephone.

Today, we have the technical know-how and manufacturing ability to design cables for a wide range of communications applications—from high-flex power cables for base stations to miniature coaxial cables for antennae. Some of the world's largest communications carriers and IT companies rely on New England Wire Technologies for interconnecting cables, cell phone base station wire and cables, and broadband cable. We offer winding wire for UL1950/IEC60950 IT applications, as well as NEWlan® for today's integrated voice, video, and data networks.

As safety and privacy concerns have grown, so has the complexity of alarm systems and security applications. New England Wire Technologies has the expertise and resources to design and produce custom communication cables that meet the increasing technical needs of today's computer-controlled electronic security equipment. We draw from a broad range of conductor sizes, materials, compounds, coatings, tapes and shield types to create superior quality cables with lower cross-talk, higher signal speed and greater integrity for longer transmission distances. Our design engineers and technical sales teams will work with you from start to finish, no matter how complex your security project.

Contact us to find out how we can help you create a custom solution to your power distribution, signal transmission, and security challenges.



## COMMUNICATION & CONTROL CABLES

New England Wire Technologies is a manufacturer of custom cables and Litz wire for the telecommunications field. From the late 1800s, we have evolved with the telecommunications industry and have been able to meet individual communications application needs such as high-flex power cables for base station applications, custom computer cables, custom LAN cables or miniature coaxial cables for antennae.

Communication & Control Composite Cables . . . . .	73
FEP/PFA & Silicone Rubber . . . . .	76
PFA & TPE . . . . .	78
FEP & Polyester . . . . .	80
PVC & Polyurethane . . . . .	82
PVC . . . . .	84
NEWlan™ Network Cables . . . . .	86
CATV, MATC, CCTV Coaxial Cables . . . . .	88
Alarm & Security . . . . .	88



# COMMUNICATION AND CONTROL COMPOSITE CABLES

New England Wire Technologies offers custom designed cables for the communication industry. We have the technical knowledge and manufacturing ability to design cables for a wide range of communication applications. We offer everything from high-flex power cables for base stations to miniature coaxial cables for antennae. The next few pages demonstrate a few of our design and manufacturing capabilities. If you have a special requirement please contact our sales department. Together with our design engineers, we will work with you from start to finish, no matter how complex your project.

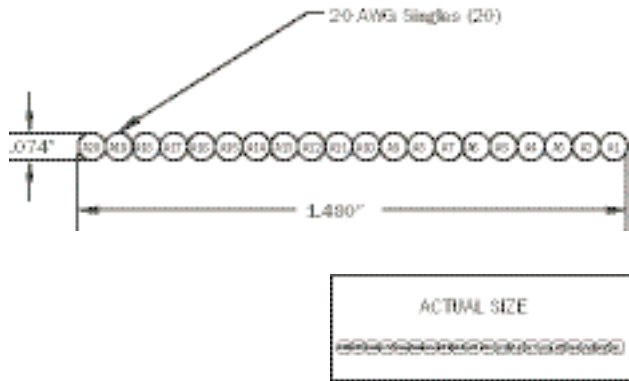

**20 Conductor Ribbon Cable:** 20 PVC insulated singles laid parallel and bonded to 1.480" wide.

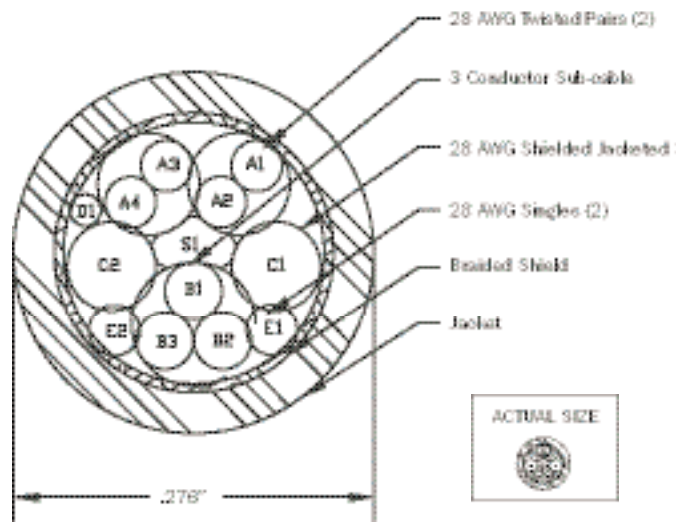

**11 Conductor Cable:** 2 twisted pairs with polyethylene insulation, 3 conductor low-noise sub-cable and 2 tinned copper singles with PVC insulation cabled around core strength member then shielded and jacketed with polyurethane to 0.276" O.D.

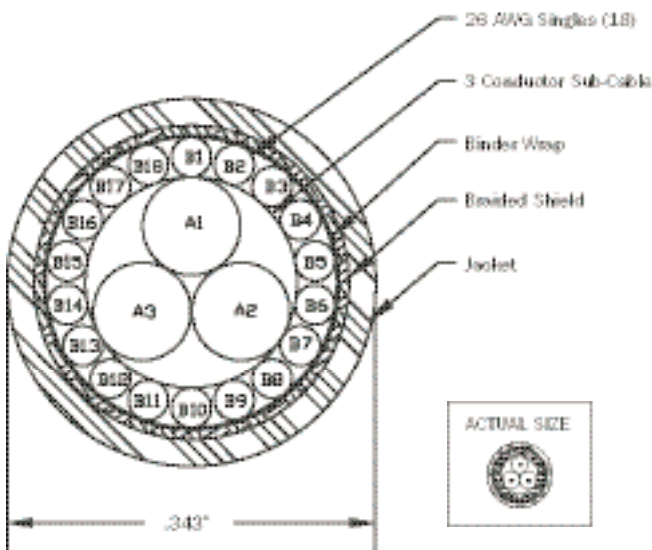

**21 Conductor Cable:** 18 singles cabled around a 3 conductor sub-cable then taped, shielded and jacketed with PVC to 0.343" O. D.

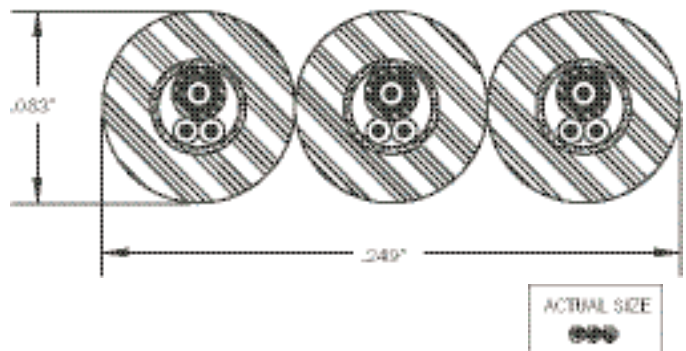

**9 Conductor Ribbon Cable:** Three NEWtral-E treated, shielded sub-cables with PVC insulation laid parallel and bonded to 0.083" by 0.249" wide .

[www.newenglandwire.com](http://www.newenglandwire.com)  
Tel: 603.838.6624

# COMMUNICATION AND CONTROL COMPOSITE CABLES, *continued*

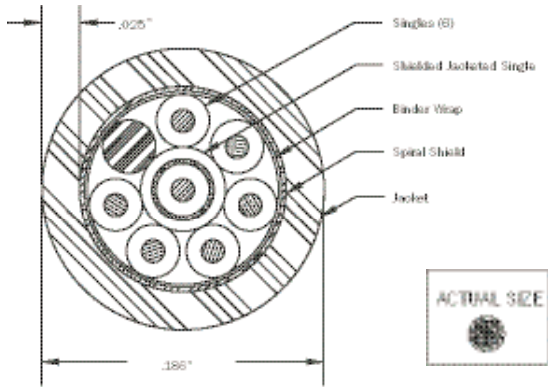

**7 Conductor Cable:** 6 - 28 AWG singles and a filler cabled around 28 AWG shielded, jacketed single then taped, spiral shielded and jacketed with PVC to 0.186" O.D.

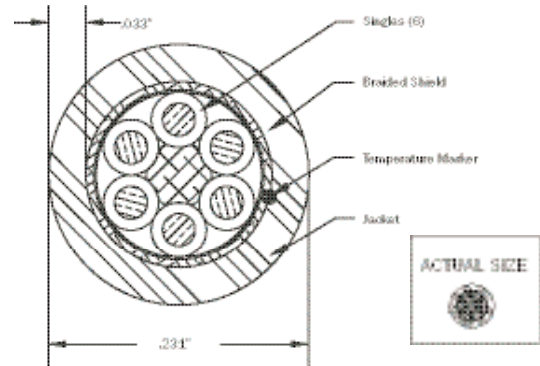

**6 Conductor Cable:** 6 - 22 AWG singles cabled around a core then taped, shielded and jacketed with PVC to 0.231" O.D.

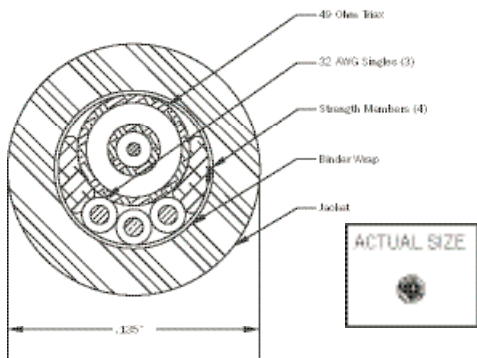

**4 Conductor Cable:** 3 - 32 AWG alloy singles cabled with 49 Ohm Triax and 4 strength members, then taped and jacketed with Polyurethane to 0.135" O.D.

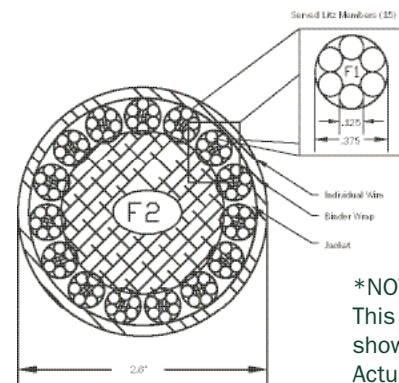

**Type 6 Litz:** 15 Litz members cabled around core, then taped and jacketed with PVC to 2.6" O.D.

# COMMUNICATION AND CONTROL COMPOSITE CABLES, *continued*

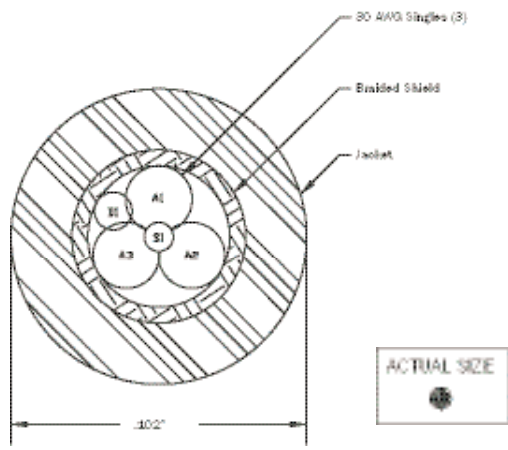

**3 Conductor Cable:** 3 - 30 AWG alloy singles cabled around core with drain wire, shielded and jacketed with PVC to 0.102" O.D.

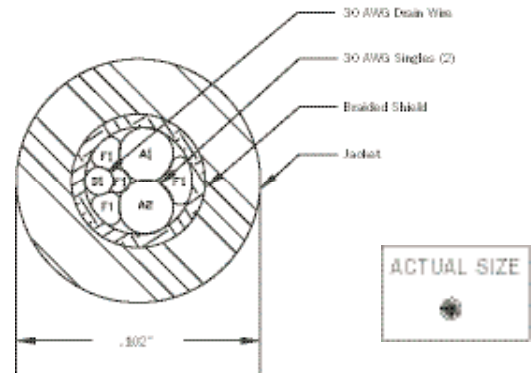

**2 Conductor Cable:** 2 - 30 AWG singles cabled with fillers and drain wire, shielded and jacketed with PVC to 0.102" O.D.

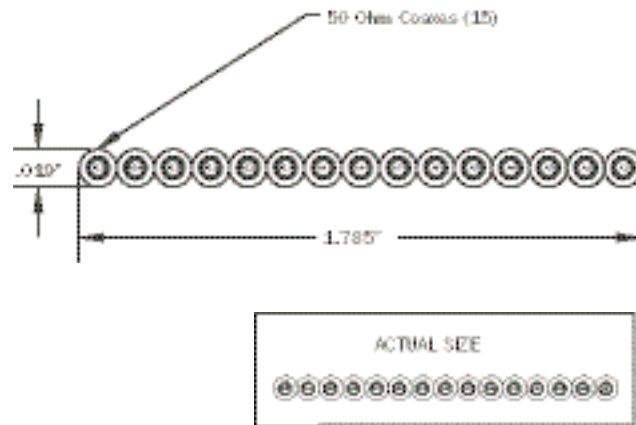

**15 Conductor Ribbon Cable:** 15 PVC insulated coaxes laid parallel and bonded to 1.785" wide.

# Ultra Flexible Single & Multiconductor FEP/PFA & Silicone Rubber Insulated Cables 250 Volts, 150° C

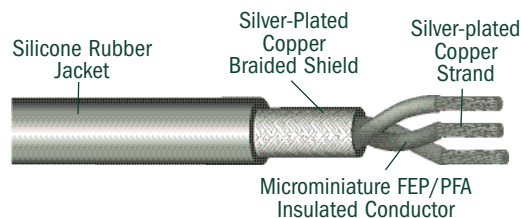

**DESCRIPTION:** Conductors are ultra flexible silver-plated copper strands insulated with 5 mil walls of color coded FEP or PFA. Extra flexible braided shields can be applied over the cabled conductors prior to jacketing with silicone rubber.

**USE:** Used where ultra flexible microminiature multiconductor cables are required; please contact our design team with your specific requirements.

Number of Conductors	SINGLE CONDUCTOR DATA				Nominal Diameter Over Cabled Conductor	SHIELD		JACKET	
	Equivalent AWG	Strand Construction	Nominal Wall Thickness	Nominal Diameter		AWG of Shield	Nominal Diameter Over Shield	Nominal Wall Thickness	Nominal OD
1	38	17/50	.005	.015	.015	44	.024	.010	.044
1	38	7/46	.005	.015	.015	44	.024	.010	.044
1	36	26/50	.005	.016	.016	44	.025	.010	.045
1	36	7/44	.005	.016	.016	44	.025	.010	.045
1	34	41/50	.005	.017	.017	44	.026	.010	.046
1	34	10/44	.005	.017	.017	44	.026	.010	.046
1	34	7/42	.005	.018	.018	44	.027	.010	.047
1	32	65/50	.005	.019	.019	44	.028	.010	.048
1	32	26/46	.005	.019	.019	44	.028	.010	.048
1	32	16/44	.005	.019	.019	44	.028	.010	.048
1	32	7/40	.005	.019	.019	44	.028	.010	.048
1	30	41/46	.005	.022	.022	44	.031	.010	.051
1	30	25/44	.005	.022	.022	44	.031	.010	.051
1	30	11/40	.005	.022	.022	44	.031	.010	.051
1	30	7/38	.005	.022	.022	44	.031	.010	.051
2	38	17/50	.005	.015	.029	44	.039	.010	.058
2	38	7/46	.005	.015	.029	44	.039	.010	.058
2	36	26/50	.005	.016	.031	44	.041	.010	.060
2	36	7/44	.005	.016	.031	44	.041	.010	.060
2	34	41/50	.005	.017	.031	44	.043	.010	.063
2	34	10/44	.005	.017	.033	44	.043	.010	.062
2	34	7/42	.005	.018	.035	44	.045	.010	.064
2	32	65/50	.005	.019	.037	44	.047	.010	.066
2	32	26/46	.005	.019	.037	44	.047	.010	.066
2	32	16/44	.005	.019	.037	44	.047	.010	.066
2	32	7/40	.005	.019	.037	44	.049	.010	.066
2	30	41/46	.005	.022	.043	44	.053	.010	.072
2	30	25/44	.005	.022	.043	44	.053	.010	.072
2	30	11/40	.005	.022	.043	44	.053	.010	.072
2	30	7/38	.005	.022	.043	44	.053	.010	.072
3	38	17/50	.005	.015	.032	44	.041	.010	.061
3	38	7/46	.005	.015	.032	44	.041	.010	.061
3	36	26/50	.005	.016	.034	44	.043	.010	.063
3	36	7/44	.005	.016	.034	44	.043	.010	.063
3	34	41/50	.005	.017	.037	44	.046	.010	.066

Our standard colors for primary and overall jackets include: white, black, red, green, yellow, blue, brown, orange, gray and violet. Custom color and/or exact color match available; please contact our design team for your specific requirement.

*All measurements are in inches unless otherwise stated.*

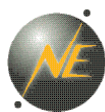

# Ultra Flexible Single & Multiconductor FEP/PFA & Silicone Rubber Insulated Cables, *continued*

Number of Conductors	SINGLE CONDUCTOR DATA				Nominal Diameter Over Cabled Conductor	SHIELD		JACKET	
	Equivalent AWG	Strand Construction	Nominal Wall Thickness	Nominal Diameter		AWG of Shield	Nominal Diameter Over Shield	Nominal Wall Thickness	Nominal OD
3	34	10/44	.005	.017	.037	44	.046	.010	.066
3	34	7/42	.005	.018	.039	44	.048	.010	.068
3	32	65/50	.005	.019	.041	44	.050	.010	.070
3	32	26/46	.005	.019	.041	44	.050	.010	.070
3	32	16/44	.005	.019	.041	44	.050	.010	.070
3	32	7/40	.005	.019	.041	44	.050	.010	.070
3	30	41/46	.005	.022	.047	44	.056	.010	.076
3	30	25/44	.005	.022	.047	44	.056	.010	.076
3	30	11/40	.005	.022	.047	44	.056	.010	.076
3	30	7/38	.005	.022	.047	44	.056	.010	.076
4	38	17/50	.005	.015	.032	44	.041	.010	.065
4	38	7/46	.005	.015	.036	44	.045	.010	.065
4	36	26/50	.005	.016	.039	44	.048	.010	.068
4	36	7/44	.005	.016	.039	44	.048	.010	.068
4	34	41/50	.005	.017	.041	44	.050	.010	.070
4	34	10/44	.005	.017	.041	44	.052	.010	.072
4	34	7/42	.005	.018	.043	44	.055	.010	.075
4	32	65/50	.005	.019	.046	44	.055	.010	.075
4	32	26/46	.005	.019	.046	44	.055	.010	.075
4	32	16/44	.005	.019	.046	44	.055	.010	.075
4	32	7/40	.005	.019	.046	44	.056	.010	.076
4	30	41/46	.005	.022	.053	44	.062	.010	.082
4	30	25/44	.005	.022	.053	44	.062	.010	.082
4	30	11/40	.005	.022	.053	44	.062	.010	.082
4	30	7/38	.005	.022	.053	44	.062	.010	.082
5	38	17/50	.005	.015	.041	44	.050	.010	.070
5	38	7/46	.005	.015	.041	44	.050	.010	.070
5	36	26/50	.005	.016	.043	44	.052	.010	.072
5	36	7/44	.005	.016	.043	44	.052	.010	.072
5	34	41/50	.005	.017	.046	44	.055	.010	.075
5	34	10/44	.005	.017	.046	44	.055	.010	.075
5	34	7/42	.005	.018	.049	44	.058	.010	.078
5	32	65/50	.005	.019	.051	44	.060	.010	.080
5	32	26/46	.005	.019	.051	44	.060	.010	.080
5	32	16/44	.005	.019	.051	44	.060	.010	.080
5	32	7/40	.005	.019	.051	44	.060	.010	.080
5	30	41/46	.005	.022	.059	44	.069	.010	.088
5	30	25/44	.005	.022	.059	44	.069	.010	.088
5	30	11/40	.005	.022	.059	44	.069	.010	.088
5	30	7/38	.005	.022	.059	44	.069	.010	.088

Our standard colors for primary and overall jackets include: white, black, red, green, yellow, blue, brown, orange, gray and violet. Custom color and/or exact color match available; please contact our design team for your specific requirement.

*All measurements are in inches unless otherwise stated.*

[www.newenglandwire.com](http://www.newenglandwire.com)

Tel: 603.838.6624

# Ultra Flexible Single & Multiconductor PFA & TPE Insulated Cables 250 Volts, 105° C

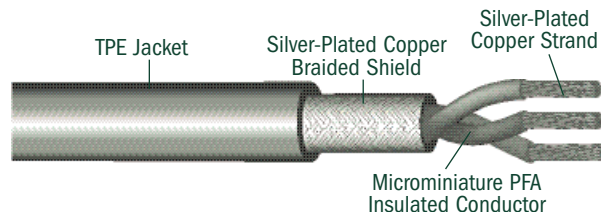

**DESCRIPTION:** Conductors are ultra flexible silver-plated copper strands insulated with 5 mil walls of color coded PFA. Extra flexible silver-plated copper braided shields can be applied over the cabled conductors prior to jacketing with TPE. Most of the items below are also available with tinned copper stranded conductors and shields.

**USE:** Ultra flexible microminiature multiconductor for use when flexibility and 105° C temperature rating are critical. Please contact our design team to discuss your specific application.

Number of Conductors	SINGLE CONDUCTOR DATA				Nominal Diameter Over Cabled Conductor	SHIELD		JACKET	
	Equivalent AWG	Strand Construction	Nominal Wall Thickness	Nominal Diameter		AWG of Shield	Nominal Diameter Over Shield	Nominal Wall Thickness	Nominal OD
1	38	17/50	.005	.015	.015	44	.024	.010	.044
1	38	7/46	.005	.015	.015	44	.024	.010	.044
1	36	26/50	.005	.016	.016	44	.025	.010	.045
1	36	7/44	.005	.016	.016	44	.025	.010	.045
1	34	41/50	.005	.017	.017	44	.026	.010	.046
1	34	10/44	.005	.017	.017	44	.026	.010	.046
1	34	7/42	.005	.018	.018	44	.027	.010	.047
1	32	65/50	.005	.019	.019	44	.028	.010	.048
1	32	26/46	.005	.019	.019	44	.028	.010	.048
1	32	16/44	.005	.019	.019	44	.028	.010	.048
1	32	7/40	.005	.019	.019	44	.028	.010	.048
1	30	41/46	.005	.022	.022	44	.031	.010	.051
1	30	25/44	.005	.022	.022	44	.031	.010	.051
1	30	11/40	.005	.022	.022	44	.031	.010	.051
1	30	7/38	.005	.022	.022	44	.031	.010	.051
2	38	17/50	.005	.015	.029	44	.039	.010	.058
2	38	7/46	.005	.015	.029	44	.039	.010	.058
2	36	26/50	.005	.016	.031	44	.041	.010	.060
2	36	7/44	.005	.016	.031	44	.041	.010	.060
2	34	41/50	.005	.017	.031	44	.043	.010	.063
2	34	10/44	.005	.017	.033	44	.043	.010	.062
2	34	7/42	.005	.018	.035	44	.045	.010	.064
2	32	65/50	.005	.019	.037	44	.047	.010	.066
2	32	26/46	.005	.019	.037	44	.047	.010	.066
2	32	16/44	.005	.019	.037	44	.047	.010	.066
2	32	7/40	.005	.019	.037	44	.049	.010	.066
2	30	41/46	.005	.022	.043	44	.053	.010	.072
2	30	25/44	.005	.022	.043	44	.053	.010	.072
2	30	11/40	.005	.022	.043	44	.053	.010	.072
2	30	7/38	.005	.022	.043	44	.053	.010	.072
3	38	17/50	.005	.015	.032	44	.041	.010	.061
3	38	7/46	.005	.015	.032	44	.041	.010	.061
3	36	26/50	.005	.016	.034	44	.043	.010	.063
3	36	7/44	.005	.016	.034	44	.043	.010	.063
3	34	41/50	.005	.017	.037	44	.046	.010	.066

Our standard colors for primary and overall jackets include: white, black, red, green, yellow, blue, brown, orange, gray and violet. Custom color and/or exact color match available; please contact our design team for your specific requirement.

*All measurements are in inches unless otherwise stated.*

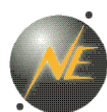

# Ultra Flexible Single & Multiconductor PFA & TPE Insulated Cables, *continued*

Number of Conductors	SINGLE CONDUCTOR DATA				Nominal Diameter Over Cabled Conductor	SHIELD		JACKET	
	Equivalent AWG	Strand Construction	Nominal Wall Thickness	Nominal Diameter		AWG of Shield	Nominal Diameter Over Shield	Nominal Wall Thickness	Nominal OD
3	34	10/44	.005	.017	.037	44	.046	.010	.066
3	34	7/42	.005	.018	.039	44	.048	.010	.068
3	32	65/50	.005	.019	.041	44	.050	.010	.070
3	32	26/46	.005	.019	.041	44	.050	.010	.070
3	32	16/44	.005	.019	.041	44	.050	.010	.070
3	32	7/40	.005	.019	.041	44	.050	.010	.070
3	30	41/46	.005	.022	.047	44	.056	.010	.076
3	30	25/44	.005	.022	.047	44	.056	.010	.076
3	30	11/40	.005	.022	.047	44	.056	.010	.076
3	30	7/38	.005	.022	.047	44	.056	.010	.076
4	38	17/50	.005	.015	.032	44	.041	.010	.065
4	38	7/46	.005	.015	.036	44	.045	.010	.065
4	36	26/50	.005	.016	.039	44	.048	.010	.068
4	36	7/44	.005	.016	.039	44	.048	.010	.068
4	34	41/50	.005	.017	.041	44	.050	.010	.070
4	34	10/44	.005	.017	.041	44	.052	.010	.072
4	34	7/42	.005	.018	.043	44	.055	.010	.075
4	32	65/50	.005	.019	.046	44	.055	.010	.075
4	32	26/46	.005	.019	.046	44	.055	.010	.075
4	32	16/44	.005	.019	.046	44	.055	.010	.075
4	32	7/40	.005	.019	.046	44	.056	.010	.076
4	30	41/46	.005	.022	.053	44	.062	.010	.082
4	30	25/44	.005	.022	.053	44	.062	.010	.082
4	30	11/40	.005	.022	.053	44	.062	.010	.082
4	30	7/38	.005	.022	.053	44	.062	.010	.082
5	38	17/50	.005	.015	.041	44	.050	.010	.070
5	38	7/46	.005	.015	.041	44	.050	.010	.070
5	36	26/50	.005	.016	.043	44	.052	.010	.072
5	36	7/44	.005	.016	.043	44	.052	.010	.072
5	34	41/50	.005	.017	.046	44	.055	.010	.075
5	34	10/44	.005	.017	.046	44	.055	.010	.075
5	34	7/42	.005	.018	.049	44	.058	.010	.078
5	32	65/50	.005	.019	.051	44	.060	.010	.080
5	32	26/46	.005	.019	.051	44	.060	.010	.080
5	32	16/44	.005	.019	.051	44	.060	.010	.080
5	32	7/40	.005	.019	.051	44	.060	.010	.080
5	30	41/46	.005	.022	.059	44	.069	.010	.088
5	30	25/44	.005	.022	.059	44	.069	.010	.088
5	30	11/40	.005	.022	.059	44	.069	.010	.088
5	30	7/38	.005	.022	.059	44	.069	.010	.088

Our standard colors for primary and overall jackets include: white, black, red, green, yellow, blue, brown, orange, gray and violet. Custom color and/or exact color match available; please contact our design team for your specific requirement.

*All measurements are in inches unless otherwise stated.*

[www.newenglandwire.com](http://www.newenglandwire.com)

Tel: 603.838.6624

# Single & Multiconductor FEP & Polyester Insulated Cables 600 Volts, 105° C

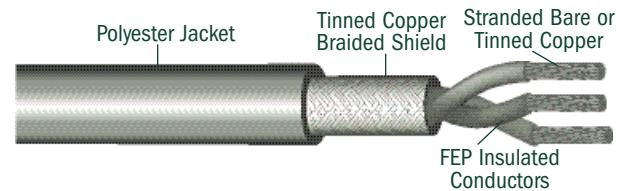

**DESCRIPTION:** Conductors are bare or tin-plated copper strands insulated with 10 mil walls of color coded FEP. Braided shields are available over the cabled conductors prior to jacketing with polyester. For special applications, spiral shields can be substituted for braided shields.

**USE:** Applications requiring high cut-through and abrasion resistance, good solvent resistance and good flexibility. Please contact our design team to discuss your specific application.

Number of Conductors	SINGLE CONDUCTOR DATA				Nominal Diameter Over Cabled Conductor	SHIELD		JACKET	
	Equivalent AWG	Strand Construction	Nominal Wall Thickness	Nominal Diameter		AWG of Shield	Nominal Diameter Over Shield	Nominal Wall Thickness	Nominal OD
1	36	7/44	.010	.026	.026	44	.035	.010	.055
1	36	19/48	.010	.026	.026	44	.035	.010	.055
1	34	19/46	.010	.027	.027	44	.036	.010	.056
1	34	7/42	.010	.028	.028	44	.037	.010	.057
1	32	19/44	.010	.030	.030	44	.039	.010	.059
1	32	7/40	.010	.029	.029	44	.038	.010	.058
1	30	19/42	.010	.032	.032	44	.041	.010	.061
1	30	7/38	.010	.032	.032	44	.041	.010	.061
1	28	19/40	.010	.035	.035	44	.044	.010	.064
1	28	7/36	.010	.035	.035	44	.044	.010	.064
1	26	19/38	.010	.039	.039	40	.053	.010	.073
1	26	7/34	.010	.039	.039	40	.053	.010	.073
1	24	19/36	.010	.044	.044	40	.058	.010	.078
1	24	7/32	.010	.044	.044	40	.058	.010	.078
1	22	19/34	.010	.050	.050	40	.064	.010	.084
1	22	7/30	.010	.050	.050	40	.064	.010	.084
1	20	19/32	.010	.058	.058	40	.072	.010	.092
1	18	19/30	.010	.068	.068	40	.082	.010	.102
2	36	7/44	.010	.026	.051	44	.060	.010	.080
2	36	19/48	.010	.026	.051	44	.060	.010	.080
2	34	19/46	.010	.027	.053	44	.062	.010	.082
2	34	7/42	.010	.028	.055	44	.064	.010	.084
2	32	19/44	.010	.030	.059	44	.068	.010	.088
2	32	7/40	.010	.029	.057	44	.066	.010	.086
2	30	19/42	.010	.032	.063	44	.072	.010	.092
2	30	7/38	.010	.032	.063	44	.072	.010	.092
2	28	19/40	.010	.035	.069	40	.083	.010	.103
2	28	7/36	.010	.035	.069	40	.083	.010	.103
2	26	19/38	.010	.039	.076	38	.090	.010	.110
2	26	7/34	.010	.039	.076	38	.090	.010	.110
2	24	19/36	.010	.044	.086	36	.109	.010	.129
2	24	7/32	.010	.044	.086	36	.109	.010	.129
2	22	19/34	.010	.050	.098	36	.121	.010	.141
2	22	7/30	.010	.050	.098	36	.121	.010	.141
2	20	19/32	.010	.058	.114	36	.137	.010	.157
2	18	19/30	.010	.068	.133	36	.156	.010	.176
3	36	7/44	.010	.026	.056	44	.065	.010	.085
3	36	19/48	.010	.026	.056	44	.065	.010	.085
3	34	19/46	.010	.027	.058	44	.067	.010	.087
3	34	7/42	.010	.028	.060	44	.069	.010	.089
3	32	19/44	.010	.030	.065	44	.074	.010	.094
3	32	7/40	.010	.029	.062	44	.071	.010	.091
3	30	19/42	.010	.032	.069	44	.078	.010	.098
3	30	7/38	.010	.032	.069	44	.078	.010	.098

All measurements are in inches unless otherwise stated.



NEW ENGLAND WIRE TECHNOLOGIES  
Innovate. Create. Accelerate.



# Single and Multiconductor Cables FEP & Polyester Insulated, *continued*

Number of Conductors	SINGLE CONDUCTOR DATA				Nominal Diameter Over Cabled Conductor	SHIELD		JACKET	
	Equivalent AWG	Strand Construction	Nominal Wall Thickness	Nominal Diameter		AWG of Shield	Nominal Diameter Over Shield	Nominal Wall Thickness	Nominal OD
3	28	19/40	.010	.035	.075	40	.089	.010	.109
3	28	7/36	.010	.035	.075	40	.089	.010	.109
3	26	19/38	.010	.039	.084	40	.098	.010	.118
3	26	7/34	.010	.039	.084	40	.098	.010	.118
3	24	19/36	.010	.044	.095	36	.118	.010	.138
3	24	7/32	.010	.044	.095	36	.118	.010	.138
3	22	19/34	.010	.050	.108	36	.131	.010	.151
3	22	7/30	.010	.050	.108	36	.131	.010	.151
3	20	19/32	.010	.058	.125	36	.148	.010	.168
3	18	19/30	.010	.068	.147	36	.169	.010	.189
4	36	7/44	.010	.026	.062	44	.071	.010	.091
4	36	19/48	.010	.026	.062	44	.071	.010	.091
4	34	19/46	.010	.027	.065	44	.074	.010	.094
4	34	7/42	.010	.028	.067	44	.076	.010	.096
4	32	19/44	.010	.030	.072	44	.081	.010	.101
4	32	7/40	.010	.029	.070	44	.079	.010	.099
4	30	19/42	.010	.032	.077	44	.086	.010	.106
4	30	7/38	.010	.032	.077	44	.086	.010	.106
4	28	19/40	.010	.035	.084	40	.098	.010	.118
4	28	7/36	.010	.035	.084	40	.098	.010	.118
4	26	19/38	.010	.039	.094	40	.108	.010	.128
4	26	7/34	.010	.039	.094	40	.108	.010	.128
4	24	19/36	.010	.044	.106	36	.129	.010	.149
4	24	7/32	.010	.044	.106	36	.129	.010	.149
4	22	19/34	.010	.050	.120	36	.143	.010	.163
4	22	7/30	.010	.050	.120	36	.143	.010	.163
4	20	19/32	.010	.058	.140	36	.162	.010	.182
4	18	19/30	.010	.068	.163	36	.186	.010	.206
5	36	7/44	.010	.026	.070	44	.079	.010	.099
5	36	19/48	.010	.026	.070	44	.079	.010	.099
5	34	19/46	.010	.027	.073	44	.082	.010	.102
5	34	7/42	.010	.028	.076	44	.085	.010	.105
5	32	19/44	.010	.030	.081	44	.090	.010	.110
5	32	7/40	.010	.029	.077	44	.088	.010	.108
5	30	19/42	.010	.032	.087	44	.096	.010	.116
5	30	7/38	.010	.032	.087	44	.096	.010	.116
5	28	19/40	.010	.035	.095	40	.109	.010	.129
5	28	7/36	.010	.035	.095	40	.109	.010	.129
5	26	19/38	.010	.039	.106	40	.120	.010	.140
5	26	7/34	.010	.039	.106	40	.120	.010	.140
5	24	19/36	.010	.044	.119	36	.142	.010	.162
5	24	7/32	.010	.044	.119	36	.142	.010	.162
5	22	19/34	.010	.050	.136	36	.159	.010	.179
5	22	7/30	.010	.050	.136	36	.159	.010	.179
5	20	19/32	.010	.058	.157	36	.180	.010	.200
5	18	19/30	.010	.068	.184	36	.207	.010	.227

Our standard colors for primary and overall jackets include: white, black, red, green, yellow, blue, brown, orange, gray and violet. Custom color and/or exact color match available; please contact our design team for your specific requirement.

*All measurements are in inches unless otherwise stated.*

[www.newenglandwire.com](http://www.newenglandwire.com)  
Tel: 603.838.6624

# Single & Multiconductor PVC & Polyurethane Insulated Cables 600 Volts, 80° C

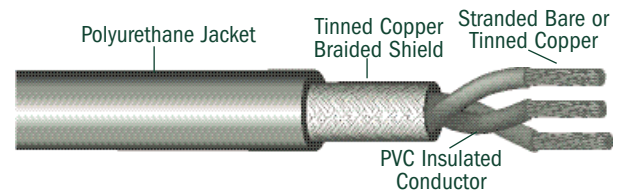

**DESCRIPTION:** Conductors are bare or tin-plated copper strands insulated with 10 mil walls of color coded PVC. Braided shields, jackets or both can be applied over the cabled conductors. For special applications, spiral shields can be substituted for braided shields.

**USE:** Applications requiring high cut-through resistance, good flexibility and other specialized applications requiring 600 volt, 80°C ultra flexible microminiature multiconductor cables. Please contact our design team for your specific application requirements.

Number of Conductors	SINGLE CONDUCTOR DATA				Nominal Diameter Over Cabled Conductor	SHIELD		JACKET	
	Equivalent AWG	Strand Construction	Nominal Wall Thickness	Nominal Diameter		AWG of Shield	Nominal Diameter Over Shield	Nominal Wall Thickness	Nominal OD
1	36	7/44	.010	.026	.026	44	.035	.010	.055
1	36	19/48	.010	.026	.026	44	.035	.010	.055
1	34	19/46	.010	.027	.027	44	.036	.010	.056
1	34	7/42	.010	.028	.028	44	.037	.010	.057
1	32	19/44	.010	.030	.030	44	.039	.010	.059
1	32	7/40	.010	.029	.029	44	.038	.010	.058
1	30	19/42	.010	.032	.032	44	.041	.010	.061
1	30	7/38	.010	.032	.032	44	.041	.010	.061
1	28	19/40	.010	.035	.035	44	.044	.010	.064
1	28	7/36	.010	.035	.035	44	.044	.010	.064
1	26	19/38	.010	.039	.039	40	.053	.010	.073
1	26	7/34	.010	.039	.039	40	.053	.010	.073
1	24	19/36	.010	.044	.044	40	.058	.010	.078
1	24	7/32	.010	.044	.044	40	.058	.010	.078
1	22	19/34	.010	.050	.050	40	.064	.010	.084
1	22	7/30	.010	.050	.050	40	.064	.010	.084
1	20	19/32	.010	.058	.058	40	.072	.010	.092
1	18	19/30	.010	.068	.068	40	.082	.010	.102
2	36	7/44	.010	.026	.051	44	.060	.010	.080
2	36	19/48	.010	.026	.051	44	.060	.010	.080
2	34	19/46	.010	.027	.053	44	.062	.010	.082
2	34	7/42	.010	.028	.055	44	.064	.010	.084
2	32	19/44	.010	.030	.059	44	.068	.010	.088
2	32	7/40	.010	.029	.057	44	.066	.010	.086
2	30	19/42	.010	.032	.063	44	.072	.010	.092
2	30	7/38	.010	.032	.063	44	.072	.010	.092
2	28	19/40	.010	.035	.069	40	.083	.010	.103
2	28	7/36	.010	.035	.069	40	.083	.010	.103
2	26	19/38	.010	.039	.076	38	.090	.010	.110
2	26	7/34	.010	.039	.076	38	.090	.010	.110
2	24	19/36	.010	.044	.086	36	.109	.010	.129
2	24	7/32	.010	.044	.086	36	.109	.010	.129
2	22	19/34	.010	.050	.098	36	.121	.010	.141
2	22	7/30	.010	.050	.098	36	.121	.010	.141
2	20	19/32	.010	.058	.114	36	.137	.010	.157
2	18	19/30	.010	.068	.133	36	.156	.010	.176
3	36	7/44	.010	.026	.056	44	.065	.010	.085
3	36	19/48	.010	.026	.056	44	.065	.010	.085
3	34	19/46	.010	.027	.058	44	.067	.010	.087
3	34	7/42	.010	.028	.060	44	.069	.010	.089
3	32	19/44	.010	.030	.065	44	.074	.010	.094
3	32	7/40	.010	.029	.062	44	.071	.010	.091
3	30	19/42	.010	.032	.069	44	.078	.010	.098
3	30	7/38	.010	.032	.069	44	.078	.010	.098

All measurements are in inches unless otherwise stated.



NEW ENGLAND WIRE TECHNOLOGIES  
Innovate. Create. Accelerate.

# Single and Multiconductor Cables

## PVC & Polyurethane Insulated, *continued*

Number of Conductors	SINGLE CONDUCTOR DATA				Nominal Diameter Over Cabled Conductor	SHIELD		JACKET	
	Equivalent AWG	Strand Construction	Nominal Wall Thickness	Nominal Diameter		AWG of Shield	Nominal Diameter Over Shield	Nominal Wall Thickness	Nominal OD
3	28	19/40	.010	.035	.075	40	.089	.010	.109
3	28	7/36	.010	.035	.075	40	.089	.010	.109
3	26	19/38	.010	.039	.084	40	.098	.010	.118
3	26	7/34	.010	.039	.084	40	.098	.010	.118
3	24	19/36	.010	.044	.095	36	.118	.010	.138
3	24	7/32	.010	.044	.095	36	.118	.010	.138
3	22	19/34	.010	.050	.108	36	.131	.010	.151
3	22	7/30	.010	.050	.108	36	.131	.010	.151
3	20	19/32	.010	.058	.125	36	.148	.010	.168
3	18	19/30	.010	.068	.147	36	.169	.010	.189
4	36	7/44	.010	.026	.062	44	.071	.010	.091
4	36	19/48	.010	.026	.062	44	.071	.010	.091
4	34	19/46	.010	.027	.065	44	.074	.010	.094
4	34	7/42	.010	.028	.067	44	.076	.010	.096
4	32	19/44	.010	.030	.072	44	.081	.010	.101
4	32	7/40	.010	.029	.070	44	.079	.010	.099
4	30	19/42	.010	.032	.077	44	.086	.010	.106
4	30	7/38	.010	.032	.077	44	.086	.010	.106
4	28	19/40	.010	.035	.084	40	.098	.010	.118
4	28	7/36	.010	.035	.084	40	.098	.010	.118
4	26	19/38	.010	.039	.094	40	.108	.010	.128
4	26	7/34	.010	.039	.094	40	.108	.010	.128
4	24	19/36	.010	.044	.106	36	.129	.010	.149
4	24	7/32	.010	.044	.106	36	.129	.010	.149
4	22	19/34	.010	.050	.120	36	.143	.010	.163
4	22	7/30	.010	.050	.120	36	.143	.010	.163
4	20	19/32	.010	.058	.140	36	.162	.010	.182
4	18	19/30	.010	.068	.163	36	.186	.010	.206
5	36	7/44	.010	.026	.070	44	.079	.010	.099
5	36	19/48	.010	.026	.070	44	.079	.010	.099
5	34	19/46	.010	.027	.073	44	.082	.010	.102
5	34	7/42	.010	.028	.076	44	.085	.010	.105
5	32	19/44	.010	.030	.081	44	.090	.010	.110
5	32	7/40	.010	.029	.077	44	.088	.010	.108
5	30	19/42	.010	.032	.087	44	.096	.010	.116
5	30	7/38	.010	.032	.087	44	.096	.010	.116
5	28	19/40	.010	.035	.095	40	.109	.010	.129
5	28	7/36	.010	.035	.095	40	.109	.010	.129
5	26	19/38	.010	.039	.106	40	.120	.010	.140
5	26	7/34	.010	.039	.106	40	.120	.010	.140
5	24	19/36	.010	.044	.119	36	.142	.010	.162
5	24	7/32	.010	.044	.119	36	.142	.010	.162
5	22	19/34	.010	.050	.136	36	.159	.010	.179
5	22	7/30	.010	.050	.136	36	.159	.010	.179
5	20	19/32	.010	.058	.157	36	.180	.010	.200
5	18	19/30	.010	.068	.184	36	.207	.010	.227

Our standard colors for primary and overall jackets include: white, black, red, green, yellow, blue, brown, orange, gray and violet. Custom color and/or exact color match available; please contact our design team for your specific requirement.

*All measurements are in inches unless otherwise stated.*

[www.newenglandwire.com](http://www.newenglandwire.com)

Tel: 603.838.6624

© 2005 New England Wire Technologies

# Ultra Flexible Single & Multiconductor PVC & PVC Insulated Cables 200 Volts, 105° C

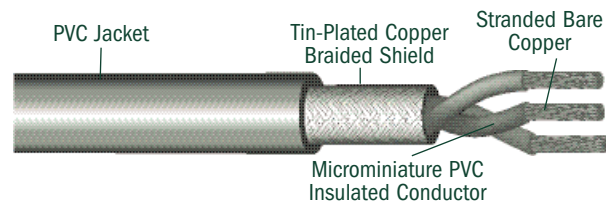

**DESCRIPTION:** Conductors are ultra flexible bare copper strands insulated with 5 mil walls of color coded 105°C PVC. Extra flexible braided shields are optional over the cabled conductors before extruding with 10 mil wall PVC jacket. Most of the items below are also available with tinned copper stranded conductors and shields.

**USE:** Applications requiring ultra flexible microminiature multiconductor cables. Please contact our design team to discuss your specific requirement.

Number of Conductors	SINGLE CONDUCTOR DATA				Nominal Diameter Over Cabled Conductor	SHIELD		JACKET	
	Equivalent AWG	Strand Construction	Nominal Wall Thickness	Nominal Diameter		AWG of Shield	Nominal Diameter Over Shield	Nominal Wall Thickness	Nominal OD
1	38	17/50	.005	.015	.015	44	.024	.010	.044
1	38	7/46	.005	.015	.015	44	.024	.010	.044
1	36	26/50	.005	.016	.016	44	.025	.010	.045
1	36	7/44	.005	.016	.016	44	.025	.010	.045
1	34	10/44	.005	.017	.017	44	.026	.010	.046
1	34	7/42	.005	.018	.018	44	.027	.010	.047
1	32	65/50	.005	.019	.019	44	.028	.010	.048
1	32	26/46	.005	.019	.019	44	.028	.010	.048
1	32	16/44	.005	.019	.019	44	.028	.010	.048
1	32	7/40	.005	.019	.019	44	.028	.010	.048
1	30	41/46	.005	.022	.022	44	.031	.010	.051
1	30	25/44	.005	.022	.022	44	.031	.010	.051
1	30	11/40	.005	.022	.022	44	.031	.010	.051
1	30	7/38	.005	.022	.022	44	.031	.010	.051
2	38	17/50	.005	.015	.029	44	.038	.010	.058
2	38	7/46	.005	.015	.029	44	.038	.010	.058
2	36	26/50	.005	.016	.031	44	.040	.010	.060
2	36	7/44	.005	.016	.031	44	.040	.010	.060
2	34	10/44	.005	.017	.033	44	.042	.010	.062
2	34	7/42	.005	.018	.035	44	.044	.010	.064
2	32	65/50	.005	.019	.037	44	.046	.010	.066
2	32	26/46	.005	.019	.037	44	.046	.010	.066
2	32	16/44	.005	.019	.037	44	.046	.010	.066
2	32	7/40	.005	.019	.037	44	.046	.010	.066
2	30	41/46	.005	.022	.043	44	.052	.010	.072
2	30	25/44	.005	.022	.043	44	.052	.010	.072
2	30	11/40	.005	.022	.043	44	.052	.010	.072
2	30	7/38	.005	.022	.043	44	.052	.010	.072
3	38	17/50	.005	.015	.032	44	.041	.010	.061
3	38	7/46	.005	.015	.032	44	.041	.010	.061
3	36	26/50	.005	.016	.034	44	.043	.010	.063
3	36	7/44	.005	.016	.034	44	.043	.010	.063
3	34	10/44	.005	.017	.037	44	.046	.010	.066
3	34	7/42	.005	.018	.039	44	.048	.010	.068
3	32	65/50	.005	.019	.041	44	.050	.010	.070
3	32	26/46	.005	.019	.041	44	.050	.010	.070

Our standard colors for primary and overall jackets include: white, black, red, green, yellow, blue, brown, orange, gray and violet. Custom color and/or exact color match available; please contact our design team for your specific requirement.

All measurements are in inches unless otherwise stated.

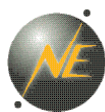

NEW ENGLAND WIRE TECHNOLOGIES  
Innovate. Create. Accelerate.

# Ultra Flexible Single & Multiconductor PVC & PVC Insulated Cables, *continued*

Number of Conductors	SINGLE CONDUCTOR DATA				Nominal Diameter Over Cabled Conductor	SHIELD		JACKET	
	Equivalent AWG	Strand Construction	Nominal Wall Thickness	Nominal Diameter		AWG of Shield	Nominal Diameter Over Shield	Nominal Wall Thickness	Nominal OD
3	32	16/44	.019	.019	.041	44	.050	.010	.070
3	32	7/40	.019	.019	.041	44	.050	.010	.070
3	30	41/46	.022	.022	.047	44	.056	.010	.076
3	30	25/44	.022	.022	.047	44	.056	.010	.076
3	30	11/40	.022	.022	.047	44	.056	.010	.076
3	30	7/38	.022	.022	.047	44	.056	.010	.076
4	38	17/50	.015	.015	.036	44	.045	.010	.065
4	38	7/46	.015	.015	.036	44	.045	.010	.065
4	36	26/50	.016	.016	.039	44	.048	.010	.068
4	36	7/44	.016	.016	.039	44	.048	.010	.068
4	34	10/44	.017	.017	.041	44	.050	.010	.070
4	34	7/42	.018	.018	.043	44	.052	.010	.072
4	32	65/50	.019	.019	.046	44	.055	.010	.075
4	32	26/46	.019	.019	.046	44	.055	.010	.075
4	32	16/44	.019	.019	.046	44	.055	.010	.075
4	32	7/40	.019	.019	.046	44	.055	.010	.075
4	30	41/46	.022	.022	.053	44	.062	.010	.082
4	30	25/44	.022	.022	.053	44	.062	.010	.082
4	30	11/40	.022	.022	.053	44	.062	.010	.082
4	30	7/38	.022	.022	.053	44	.062	.010	.082
5	38	17/50	.015	.015	.041	44	.050	.010	.070
5	38	7/46	.015	.015	.041	44	.050	.010	.070
5	36	26/50	.016	.016	.043	44	.052	.010	.072
5	36	7/44	.016	.016	.043	44	.052	.010	.072
5	34	10/44	.017	.017	.046	44	.055	.010	.075
5	34	7/42	.018	.018	.049	44	.058	.010	.078
5	32	65/50	.019	.019	.051	44	.060	.010	.080
5	32	26/46	.019	.019	.051	44	.060	.010	.080
5	32	16/44	.019	.019	.051	44	.060	.010	.080
5	32	7/40	.019	.019	.051	44	.060	.010	.080
5	30	41/46	.022	.022	.060	44	.069	.010	.089
5	30	25/44	.022	.022	.060	44	.069	.010	.089
5	30	11/40	.022	.022	.060	44	.069	.010	.089
5	30	7/38	.022	.022	.060	44	.069	.010	.089

Our standard colors for primary and overall jackets include: white, black, red, green, yellow, blue, brown, orange, gray and violet. Custom color and/or exact color match available; please contact our design team for your specific requirement.

*All measurements are in inches unless otherwise stated.*

[www.newenglandwire.com](http://www.newenglandwire.com)  
Tel: 603.838.6624

# NEWlan™ Networking Cables

We offer distributors some of the highest performing Networking Cables available on the market today. Our NEWlan™ series of cables meet or exceed all the applicable TIA/EIA specifications. They offer excellent bandwidth for current 1 Gbit/second Ethernet applications as well as emerging applications like IP based full motion video, IP based security, voice over IP and 10G Ethernet applications. These cables will allow you to maximize your investments for years to come. Available to distributors in ocean container shipments directly from our facilities in China.

## NEWlan™ Category-6E Gold

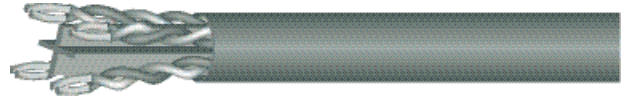

**DESCRIPTION:** 4 unshielded twisted pair cable using proprietary design and manufacturing techniques. 23 AWG bare copper center conductor, Polyolefin insulation, pairs with staggered lays, a cross-web filler and PVC jacket.

OD = 0.265 inches

Bending Radius = Minimum 1 inch

Available on reel or reel in a box

- Highest margin product available. 8-dB headroom in NEXT and ACR versus TIA/EIA.
- Tested to 600 Mhz with verified stability.
- 34% increase in signal strength at 100 Mhz and 50% increase at 250 Mhz.
- 3-year warranty on the cable.
- UL listed Type CMR and ETL verified to TIA/EIA 568-B.2-1 Cat 6.

## NEWlan™ Category-6 Premium

**DESCRIPTION:** 4 unshielded twisted pair cable utilizing 23 AWG bare copper center conductor, Polyolefin insulation, pairs with staggered lays, a cross-web filler and PVC jacket.

OD = 0.240 inches

Bending Radius = Minimum 1 inch

Available on reel or reel in a box

- Premium cable with a minimum 3 dB improvement in NEXT and ACR versus Cat-6.
- 1-year warranty of the cable.
- UL listed Type CMR and ETL verified to TIA/EIA 568-B2-1 Cat 6.

## NEWlan™ Category-6 Patch Cable

**DESCRIPTION:** 4 unshielded twisted pair cable utilizing 24 AWG stranded bare copper center conductor, Polyolefin insulation, pairs with staggered lays, a cross-web filler and PVC jacket.

OD = 0.250 inches

Bending Radius = Minimum 1 inch

Available on reel or reel in a box

- For making equipment cords and crossconnect cords in horizontal cabling system.
- 1-year warranty on the cable
- UL listed Type CMR and ETL verified to TIA/EIA 568-B.2-1 Cat 6 Patch Cable.



## NEWlan™ Networking Cables, *continued*

### NEWlan™

#### Category-5e Premium:

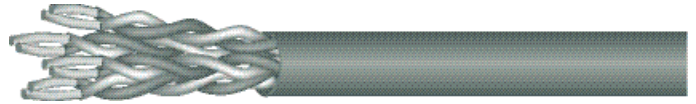

**DESCRIPTION:** 4 pair unshielded twisted pair cable with 24 awg solid bare copper conductor, Polyolefin insulation, staggered pair lays, PVC jacket.

- Exceeds TIA/EIA standards. Minimum 5-dB improvement in NEXT.
- Tested to 350 Mhz with verified stability.
- 1-year warranty on the cable.
- UL Listed Type CMR and ETL verified to TIA/EIA-568-B.2 Category-5e.

### NEWlan™

#### Category 5e Patch

**DESCRIPTION:** 4 pair unshielded twisted pair cabled with 24 awg stranded bare copper conductor, Polyolefin insulation, staggered pair lays, PVC jacket.

- For making equipment cords and crossconnect cords in horizontal cabling systems.
- 1-year warranty on the cable.
- UL Listed Type CMR and ETL verified to TIA/EIA-568-B.2 Category-5e Patch.

NEWlan™ Category-6 and Category-5e with overall foil shield are also available.

NEWlan™ Networking Cables for Rugged Environment can be manufactured using specialty jacket materials. Please contact our specialty sales team to discuss your specific requirements.

### NEWlan™

#### Hybrid Bundled Cable for Home Automations

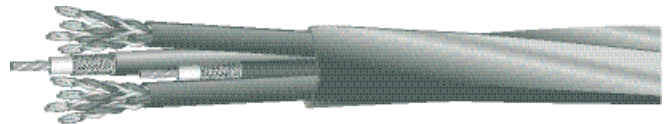

NEWlan™ Hybrid Bundled Cable is a composite cable consisting of two Category 5e 100-Ohm cables, two RG-6/U 75 Ohm Quad shielded coaxial cables with or without two simplex fiber optic cables. The elements can be cabled together and skip-bound or jacketed with an outer PVC jacket.

- For installation where LAN and coaxial connectivity are required.

[www.newenglandwire.com](http://www.newenglandwire.com)

Tel: 603.838.6624

© 2005 New England Wire Technologies

# CATV, MATV, CCTV COAXIAL CABLES

Our standard RG cables for CATV, MATV and CCTV are made to exacting performance standards, yet cost effectively. The cables can be sweep tested to 3.0 Ghz.

Alternate constructions with different center conductors, and/or braid coverage are available. Please contact our design team for your specific requirement.

Product	Construction	OD Inch	OD mm	Impedance Ohms	Nominal Velocity, %
RG-174/U Type	26 AWG, 7 strand bare copper covered steel, PE insulation, 90% tinned copper braid, PVC jacket.	.110	2.79	75	66
RG-179/U Type	30 AWG, 7 strand silver coated copper covered steel, PFA insulation, 95% silver coated copper braid shield, tinted brown FEP jacket.	.100	2.54	75	68
RG-316/U Type	26 AWG, 7 strand silver coated copper covered steel, PFA insulation, 95% silver coated copper braid shield, tinted white or brown FEP jacket.	.098	2.50	50	68

# ALARM & SECURITY CABLES



Cross Section

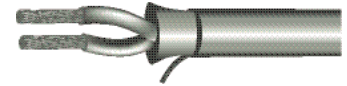

Modern alarm and security systems are very sophisticated. To support signal transmission, they require the highest quality cables that are free of noise ingress. New England Wire has designed a range of cables that have proven to be highly reliable and cost effective.

**DESCRIPTION** The cables are available in various AWG sizes with PVC, PE or foamed PE insulation, overall aluminum mylar tape with a drain wire and PVC jacket.

**SAFETY STANDARD** The cables meet UL CL2, CL3 and CM requirements and pass UL's vertical cable tray flame test.

Number of Conductors	CONDUCTOR			Drain AWG	JACKET	
	AWG Size	Construction	Nominal Wall Thickness		Nominal Wall Thickness	Nominal OD
6	18	19/30	.015	20	.038	.404
4	24	7/32	.019	24	.031	.266
4	24	7/32	.022	24	.049	.340
4	22	7/30	.009	24	.025	.168
4	18	19/30	.010	20	.035	.245
3	18	16/30	.018	20	.033	.246
2	24	7/32	.022	24	.039	.231
2	22	7/30	.016	22	.025	.175
2	20	7/28	.016	20	.028	.204
2	18	16/30	.019	20	.028	.222
2	16	19/29	.032	18	.032	.312
2	14	19/26	.032	16	.035	.354

Items listed on this page available in large quantities directly from our factory in China. Please contact our design team to discuss your specific requirements.

All measurements are in inches unless otherwise stated.



NEW ENGLAND WIRE TECHNOLOGIES  
Innovate. Create. Accelerate.





## AUDIO/VIDEO CABLES

We are in the midst of an entertainment and multimedia revolution and delivering high quality sound and pictures has never been more important.

That is why so many audio, video and home entertainment equipment manufacturers partner with New England Wire Technologies when they need to eliminate electromagnetic distortion and reduce dielectric losses.

We produce custom wire and cable products utilizing materials such as oxygen-free copper with gold, silver, nickel or tin plating, magnet wire, and Litz conductors as well as our proprietary NEWcel® dielectrics and NEWtral® low-noise coatings and compounds. Plus we offer custom color matching, custom printing and special strand configurations. New England Wire Technologies can meet the quality demands of high-end consumer and commercial audiovisual installations including home entertainment systems, recording studios, and theaters for both speaker and component connections. With the addition of our manufacturing facilities in China, we are now able to cost effectively produce high volume, custom audio/video cables. Call for a price quote today.

## **AUDIO/VIDEO CABLES**

New England Wire Technologies manufactures custom audio/video cable to very demanding specifications. Our experienced engineers are thoroughly familiar with audio/video wire and cable design issues and will supply you with custom solutions that help to eliminate electromagnetic distortion and dielectric losses that typically affect sound quality in audio/video cables.

Audio Video Composite Cables . . . . .	91
HDMI . . . . .	95
Audio Video Cables . . . . .	96

# AUDIO VIDEO COMPOSITE CABLES

New England Wire Technologies offers custom audio video cables designed to eliminate electromagnetic distortion and reduce dielectric losses for high quality sound and pictures. We manufacture custom wire and cable products utilizing oxygen-free copper with gold, silver, nickel or tin plating, magnet wire and Litz conductors. We have produced high-conductivity microphone cables, analog/digital audio and video cables, speaker cables, snake audio cables, RGB cables, S-video cables, multi-coax bundles and composite audio-video cables for multimedia, camera applications. The next few pages demonstrate a few of our design and manufacturing capabilities. Please call our design team to see how we can assist you with your specific requirements.

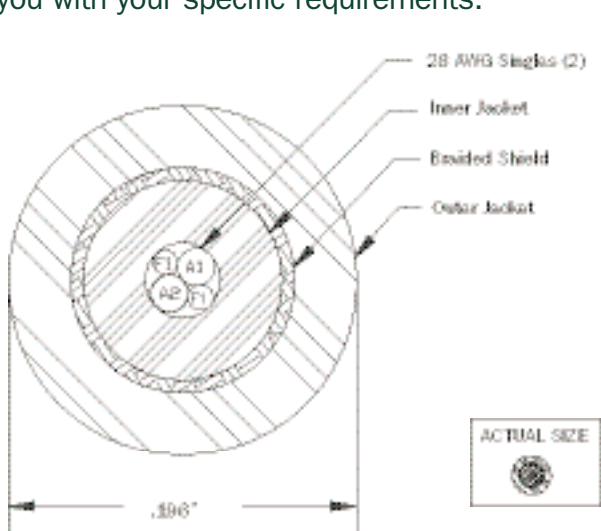

**2 Conductor Audio Cable:** 2 PFA insulated conductors twisted with fillers, jacketed with NEWcel®, shielded and then jacketed with PVC to 0.196" O.D.

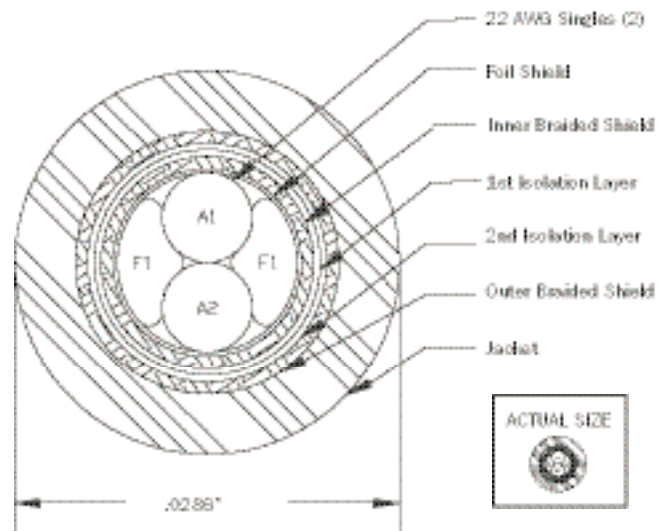

**110 Ohm Twinax Cable:** 2 singles and 2 cotton fillers cabled then tape shielded, copper braid shielded and jacketed with PVC to 0.286" O.D.

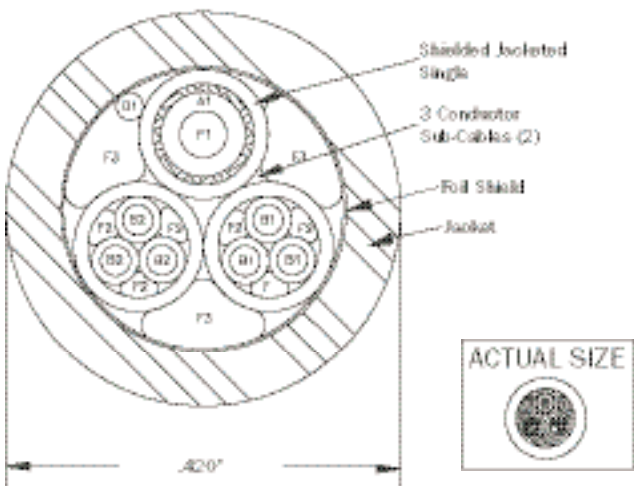

**7 Conductor Audio Cable:** Shielded jacketed single with fiberglass core and 2- 3 conductor oxygen free subcables cabled with fillers and drain wire, foil shielded and jacketed to 0.420" O.D.

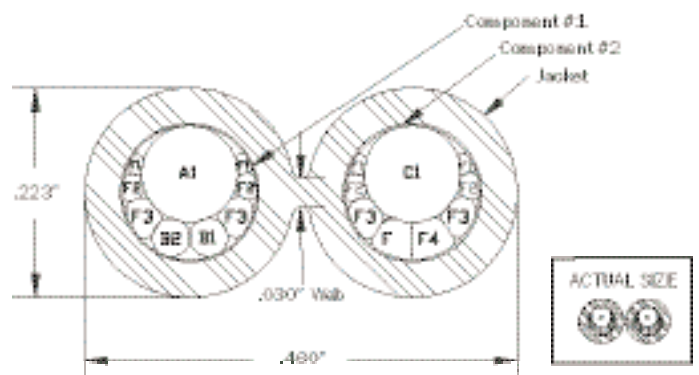

**4 Conductor (2 Component) Zip Cord:** One component consisting of a 22 AWG single and 2 - 26 AWG singles cabled with fillers and PTFE tape wrapped laid parallel with second component of 22 AWG single and fillers with PTFE tape wrap, and extruded with PVC in zip cord style to a total width of 0.460" O.D.

[www.newenglandwire.com](http://www.newenglandwire.com)

Tel: 603.838.6624

# AUDIO VIDEO COMPOSITE CABLES, *continued*

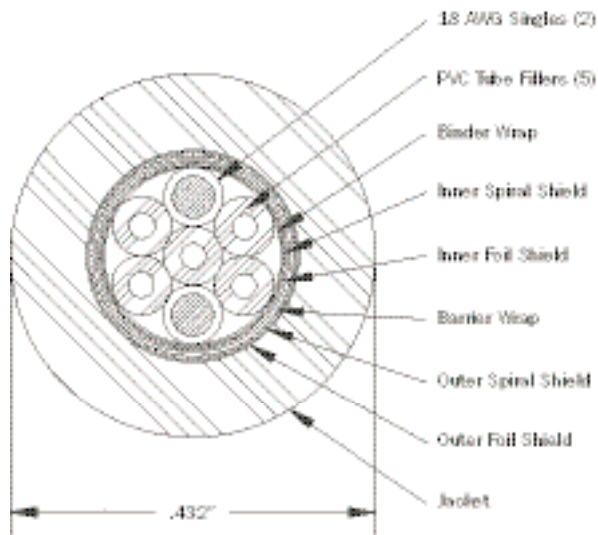

**2 Conductor Cable:** 2 - 18 AWG Polyurethane singles insulated with FEP and 4 PVC tubes cabled around tube core, wrapped, spiral shielded, foil shielded, taped, tinned copper spiral shielded, and foil shielded then jacketed with polyurethane to 0.432" O.D.

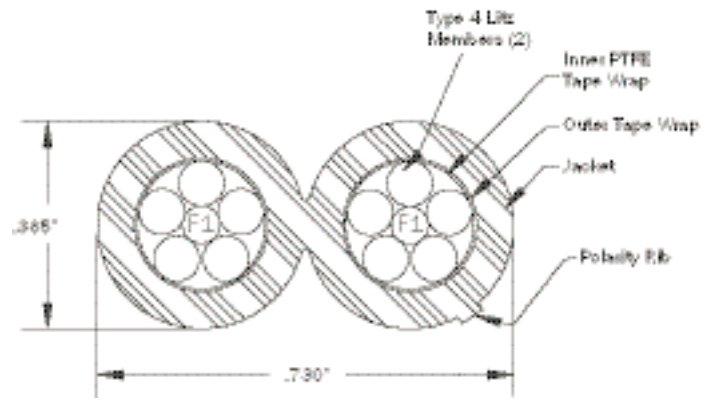

**2 Conductor Zip Cord:** 2 Type 4 Litz members, taped then laid parallel and extruded zip cord style with PVC to 0.730" wide x 0.365" thick.

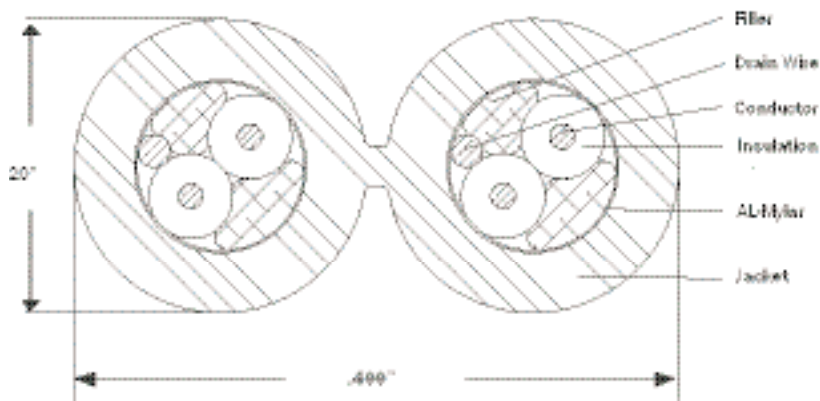

**Zip Cord Style Audio Interconnect:** 2 Polyethylene insulated conductors cabled with fillers and drain wire the foil shielded and jacketed with PVC in zip cord configuration to 0.488" wide x 0.220" thick.

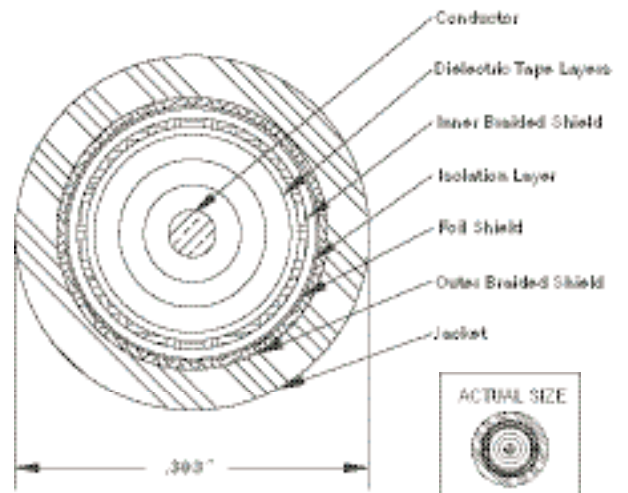

**75 Ohm Coax:** 16 AWG OFHC conductor with low-density unsintered PTFE tape, inner braided shield, PFA isolation layer and aluminum/mylar foil shield under a bare copper outer braided shield and then jacketed with PVC to 0.383" O.D.



# AUDIO VIDEO COMPOSITE CABLES, *continued*

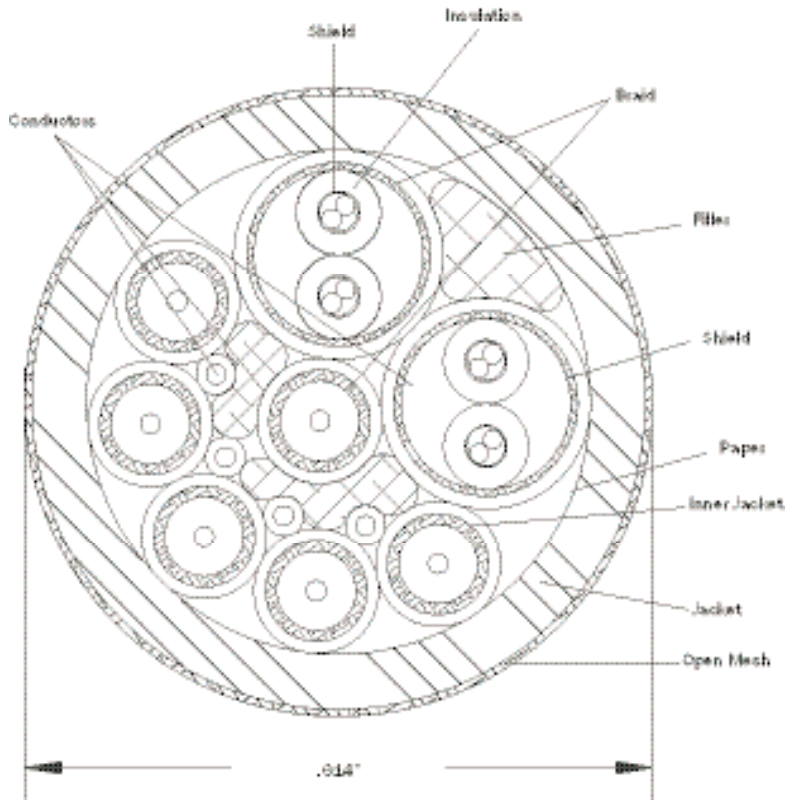

**14 Conductor Composite Cable:** 6 Coaxes cabled with 4 control wires, 2 balanced pairs and fillers then insulated with PVC and shielded to 0.614".

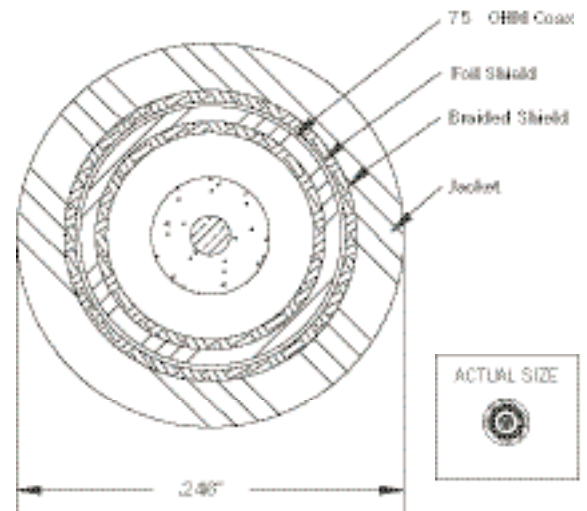

**Digital Link Cable:** 1-75 Ohm coax wrapped with aluminum/mylar tape, shielded and jacketed with PVC to 0.246" O.D.

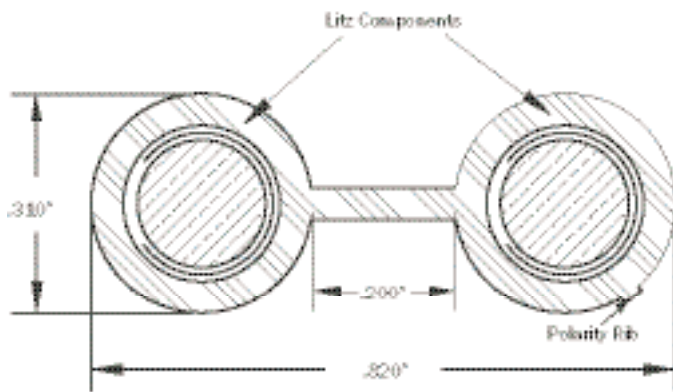

**2 Conductor:** 2 8 AWG Litz components laid parallel and PVC jacketed with web between components and polarity rib on one leg of cable to 0.820" wide x 0.310" thick.

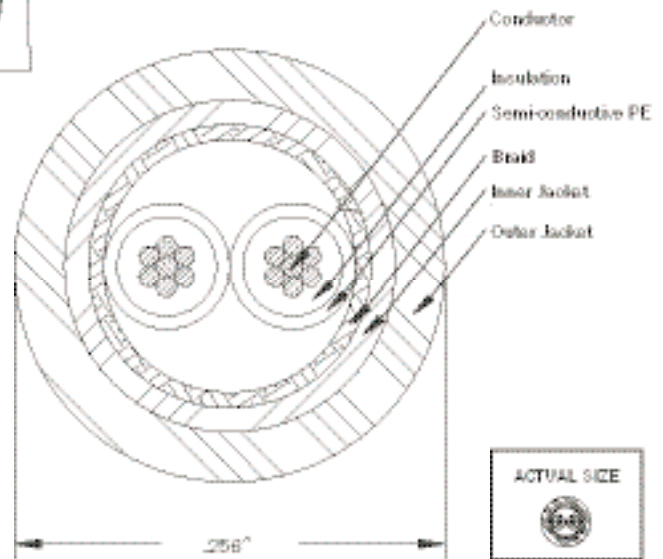

**Audio Interconnect:** 2 solid and stranded copper conductors insulated with Polyethylene, semi-conductive Polyethylene, braided and jacketed with two outside layers of PVC insulation to 0.256" O.D.



# AUDIO VIDEO COMPOSITE CABLES, *continued*

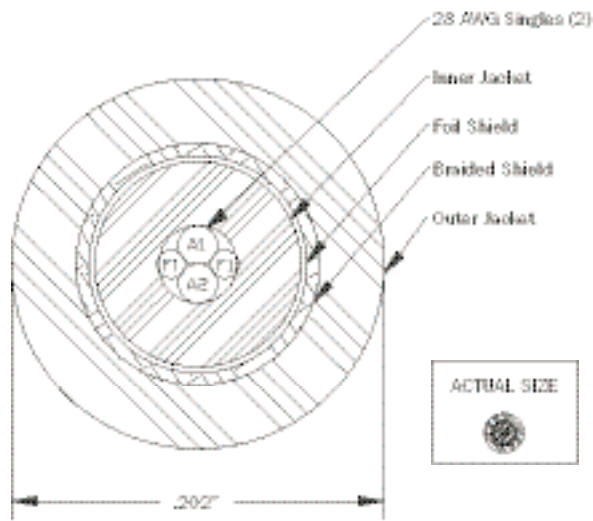

**2 Conductor Cable:** 2 bare OF copper singles cabled with 2 monofilaments in interstices, coated with NEWcel®, foil shielded then shielded with bare copper braid and insulated with PVC outer jacket to 0.202" O.D.

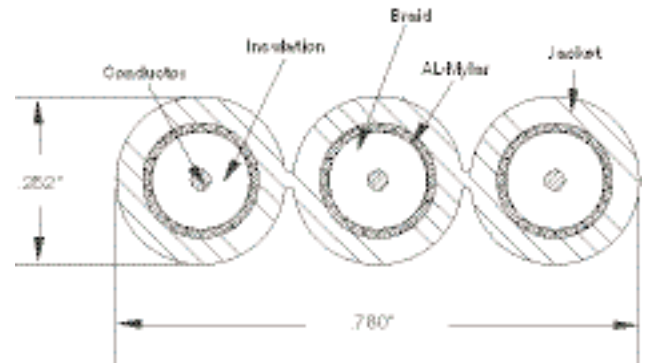

**High Resolution Video Interconnect Cable:** 3 copper conductors with foamed polyethylene insulation, Al-Mylar tape and copper braid laid parallel and then jacketed with PVC to 0.780" x 0.262".

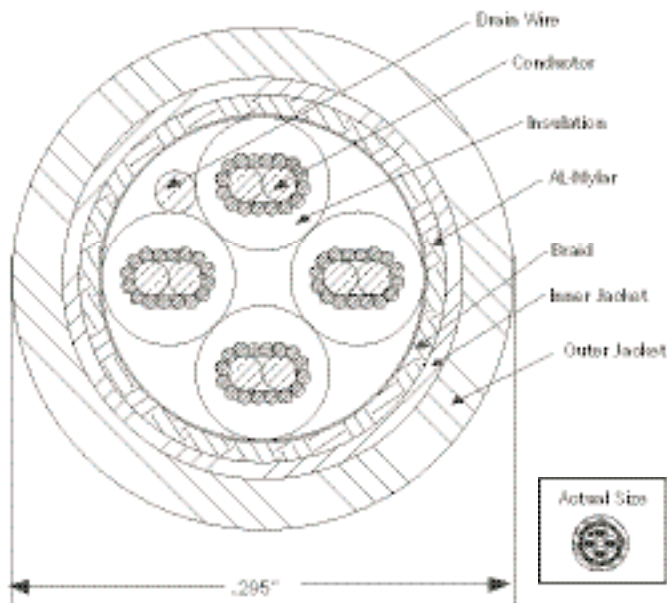

**Interconnect/Speaker Cable:** 4 conductors Polyethylene insulated conductors cabled with drain wire, foil and copper shielded then jacketed with PVC to 0.295" O.D.

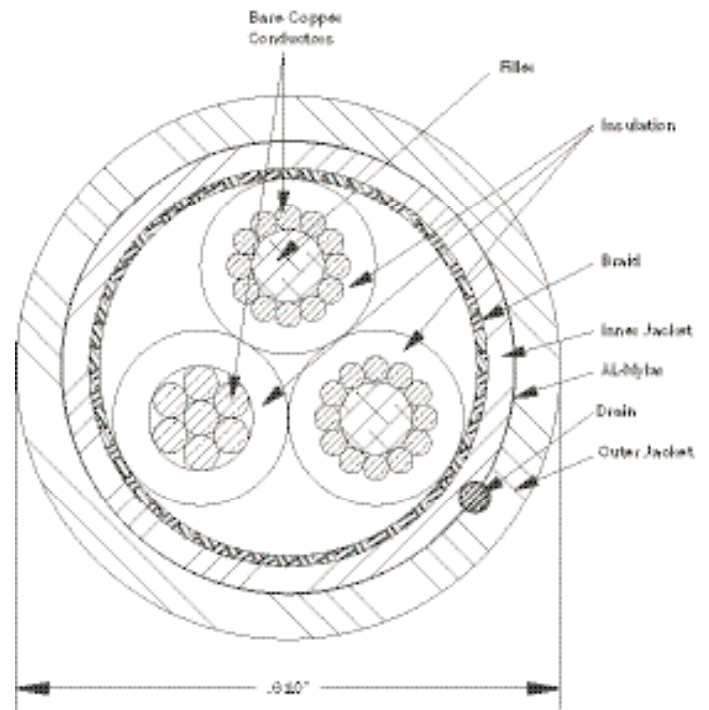

**High Current Audio Power Cord:** 3 insulated conductors are cabled with an overall braided shield, jacketed, and foil shielded with drain wire before jacketing with PVC.



# HDMI CABLES

High-Definition Multimedia Interface (HDMI) is the first and only industry-supported, uncompressed, all-digital audio/video interface. HDMI provides an interface between any audio/video source, such as a set-top box, DVD player or A/V receiver and an audio and/or video monitor, such as a digital television (DTV), over a single cable.

HDMI supports standard, enhanced or high-definition video, plus multi-channel digital audio on a single cable. It transmits all ATSC HDTV standards and supports 8-channel digital audio, with bandwidth to spare to accommodate future enhancements and requirements.

High-volume HDMI cable orders are manufactured and shipped directly to you from our factory in China. Please contact our design team to discuss your requirements.

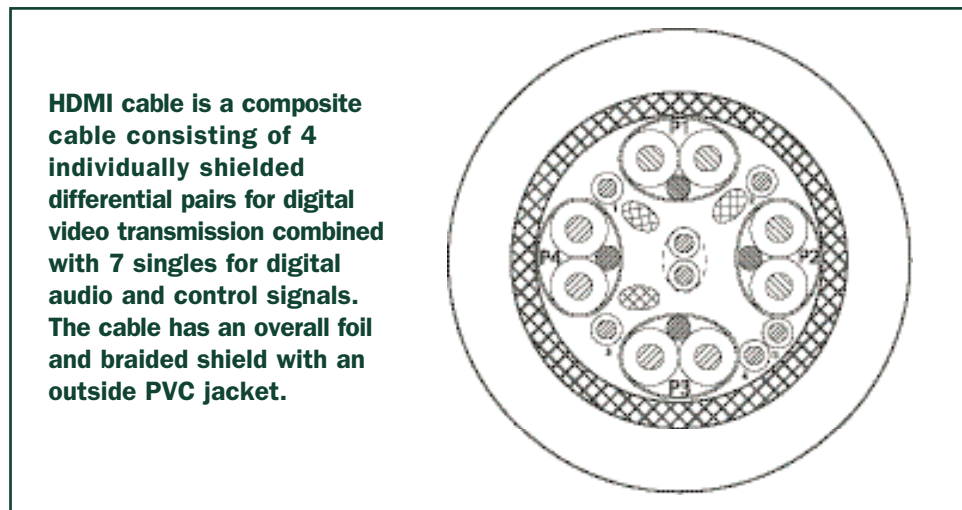

### Electrical Specifications, HDMI Cable:



Impedance (400MJ~1GHz) $\Omega$	100 $\pm$ 10
Differential Mode Delay, ns/m maximum	5.05
Intra Pair Skew, ps/assembly	151
Attenuation, dB/assembly	8.00(0.3~825MHz)
	21.00(825~2475MHz)
	30.00(2475~4125MHz)

Dimensions of HDMI Cable: AWG size of each conductor	Cable OD Inches	Cable OD mm
30 AWG	.236	6.0
28 AWG	.276	7.0
26 AWG	.335	8.5
24 AWG	.354	9.0

*Cable tested at 3, 5, 7 and 9 meter lengths to qualify.*

[www.newenglandwire.com](http://www.newenglandwire.com)  
Tel: 603.838.6624

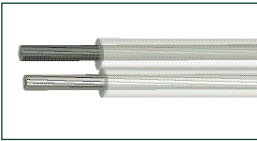
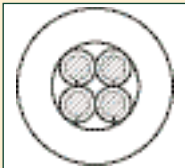
# Audio-Video Cables

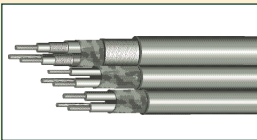
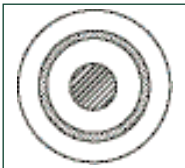
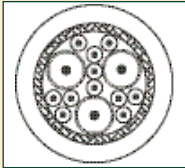
Product	Product Image	Description	OD Inch	OD mm	Impedance Ohms
Microphone Cable High Clarity		16 AWG composite bare copper conductor, Polyolefin insulation, semi-conductive shield, braid, and PVC jacket.	.275	7.0	N/A
Speaker Cable		16 AWG OFHC copper with clear PVC jacket.	1.50 x .305	3.8 x 7.6	N/A
Quad Audio Cable		4 20 AWG conductors with PVC insulation, cabled as a quad with a shielding tape, and transparent blue PVC jacket.	.216	5.5	N/A
S-Video Cable with double shielding		2 coaxes: 30 AWG OFHC copper each with tape and braided shield. cabled together with outside shielding tape, braid, and white PVC jacket.	.248	6.3	75
RGB Component Cable		3 coaxes: 24 AWG OFHC copper with a double shield, laid in parallel configuration, and then jacketed overall with beige PVC.	.250 x .780	6.35 x 19.85	75
Precision Analog/ Digital Video Coax		20 AWG Coax with 32 strand OFHC copper, foam PE insulation, foil and braided shield, then jacketed with transparent black PVC.	.236	6.00	75
High Resolution VGA/UXGA cable, small size		3 Coax Composite with 11 audio/control 30 AWG wires with double shield and overall black PVC jacket.	.204	5.2	75

\* Cables available with a variety of jackets including clear, transparent, neon and solid colors. High volume orders are available for shipment directly from our facilities in China. Please contact our design team to discuss your specific high volume requirements.







## MICROMINIATURE & MINIATURE COAXIAL CABLES

Manufacturing miniature coaxial cable for medical electronic applications requires precision equipment and a depth of expertise that has been the hallmark of New England Wire Technologies since our founding.

We recognize the importance of transmission line performance for maximizing signal quality in high-frequency systems. Instead of matching the system to the cable, we design and manufacture custom coaxial cables to match the characteristic impedance, capacitance and attenuation requirements of the specific application. We also offer coaxial cables for more common applications that can be added to composite cable configurations.

Our broad range of capabilities enables us to manufacture precision coaxes with conductor sizes as small as 42 AWG in countless material and plating options, dielectric thickness as low as .001", dielectric materials (solid and foamed) in various temperature ranges and performance properties, braided and spiral shields and foil tape layers. Precision in-process and final testing equipment ensures that specified performance is achieved.



## MICROMINIATURE & MINIATURE COAXIAL CABLES

Our line of miniature coaxial cables range in size from microminiature 42 AWG to 8 AWG in both custom and standard shielded, round or flat-wire braided and spiral and foil-wrapped constructions. Additionally we offer a large selection of extruded dielectric materials including polyethylene, polypropylene, fluoropolymers such as FEP, PFA and ETFE as well as full-density and expanded PTFE tapes.

Custom microminiature and miniature coaxial cables can be manufactured in production runs as low as 1000 feet. Please contact our design team to discuss how our capabilities can best be applied to your custom coaxial cable requirement.

Microminiature 42-34 AWG . . . . .	99
Miniature 32-34 AWG1 . . . . .	99
NEWcel® Foamed Dielectrics . . . . .	101

# MICROMINIATURE (42-34 AWG) & MINIATURE (32-24 AWG) COAXIAL CABLES

New England Wire Technologies designs and manufactures a wide range of coaxes from highly specialized miniature coaxes to audio/video coaxes and industry standard RG series coaxes.

Microminiature Coaxial Cables (42 - 34 AWG) are typically offered with fluoropolymer dielectrics to yield the smallest size and lowest loss cables possible. Ideal for short distance signal transmission, applications include antenna leads, ccd cables, ultrasound cables and test equipment leads. Due to their small size, composite cables can be manufactured with high densities of these components; samples of composite cables using coaxes are illustrated in medical, instrumentation, communications & controls, and audio/video sections of this catalog.

The constructions listed below represent a sampling of our capabilities. Custom cables will be designed to match the specific performance requirements of your application. Please contact our design team for your specific requirements.

AWG	Stranding	Dielectric Diameter	Shield AWG	Type of Shield	Jacket OD	Capacitance C (pF/ft)
<b>50 OHM - PFA DIELECTRIC</b>						
42	7/50	.006	44	Spiral	.020	43.80
40	7/48	.008	44	Spiral	.022	37.40
38	7/46	.011	44	Spiral	.025	36.70
38	7/46	.009	44	Braided	.027	34.70
36	7/44	.014	44	Spiral	.028	35.60
36	7/44	.013	44	Braided	.031	32.10
34	7/42	.018	44	Spiral	.032	34.87
34	7/42	.018	44	Braided	.036	30.70
<b>75 OHM - PFA DIELECTRIC</b>						
42	7/50	.011	44	Spiral	.027	24.70
42	7/50	.008	44	Braided	.028	24.50
40	7/48	.015	44	Spiral	.031	22.55
40	7/48	.013	44	Braided	.033	22.00
38	7/46	.018	44	Spiral	.034	23.54
38	7/46	.019	44	Braided	.039	20.86
36	7/44	.027	44	Spiral	.043	21.31
36	7/44	.026	44	Braided	.046	20.58
34	7/42	.035	44	Spiral	.051	20.90
34	7/42	.035	44	Braided	.055	20.03

Miniature coaxial cables (24 - 32 AWG) are available in countless combinations of conductor and insulation materials (including NEWcel® foamed dielectrics), stranding options and shield configurations. Ideal for short and medium distance high-speed and low-loss signal transmission, applications include antenna leads, audio/video, sensors and test and measurement. The miniature size and ultra flexibility of these cables make them ideal for composite cable constructions as illustrated elsewhere in our catalog.

The constructions listed below represent a sampling of our capabilities. Custom cable designs will be performed to match the specific requirements of the application. Please call our design team to discuss your specific requirements.

AWG	Stranding	Dielectric Diameter	Shield AWG	Type of Shield	Jacket OD	Capacitance C (pF/ft)
<b>50 OHM - PFA DIELECTRIC</b>						
32	19/44	.027	40	Spiral	.047	32.02
32	19/44	.025	40	Braided	.051	30.49
30	19/42	.031	40	Spiral	.051	33.56
30	19/42	.031	40	Braided	.057	30.02
28	19/40	.040	40	Spiral	.060	32.40
28	19/40	.040	40	Braided	.066	30.02
26	19/38	.051	40	Spiral	.071	32.69
26	19/38	.053	40	Braided	.079	29.56
24	19/36	.063	40	Spiral	.083	33.52
24	19/36	.068	40	Braided	.094	29.65

All measurements are in inches unless otherwise stated.

[www.newenglandwire.com](http://www.newenglandwire.com)  
Tel: 603.838.6624

## MINIATURE COAXIAL CABLES, *continued*

AWG	Stranding	Dielectric Diameter	Shield AWG	Type of Shield	Jacket OD	Capacitance C (pF/ft)
<b>50 OHM - FOAMED FLUOROPOLYMER DIELECTRIC</b>						
28	19/40	.036	40	Spiral	.056	27.30
28	19/40	.034	40	Braided	.060	25.80
26	19/38	.046	40	Spiral	.066	27.20
26	19/38	.044	40	Braided	.070	25.50
24	19/36	.058	40	Spiral	.076	27.40
24	19/36	.058	40	Braided	.084	25.50
<b>75 OHM - PFA DIELECTRIC</b>						
32	19/44	.048	40	Spiral	.070	20.93
32	19/44	.048	40	Braided	.076	20.00
30	19/42	.058	40	Spiral	.080	20.88
30	19/42	.060	40	Braided	.088	19.70
28	19/40	.072	40	Spiral	.094	21.01
28	19/40	.076	40	Braided	.104	19.70
26	19/38	.092	40	Spiral	.114	20.93
26	19/38	.098	40	Braided	.126	19.70
24	19/36	.115	40	Spiral	.137	22.10
24	19/36	.126	40	Braided	.154	19.61
<b>75 OHM - FOAMED FLUOROPOLYMER DIELECTRIC</b>						
32	19/44	.038	40	Spiral	.060	18.30
32	19/44	.037	40	Braided	.065	17.30
30	19/42	.043	40	Spiral	.065	19.10
30	19/42	.046	40	Braided	.074	17.20
28	19/40	.054	40	Spiral	.076	19.10
28	19/40	.059	40	Braided	.087	17.20
26	19/38	.072	40	Spiral	.094	18.50
26	19/38	.077	40	Braided	.105	17.00
24	19/36	.088	40	Spiral	.110	19.00
24	19/36	.098	40	Braided	.126	17.10

\* All coaxial cables are designed, specified and tested at frequencies of 10 Mhz for characteristic impedance and 1 kHz for capacitance unless otherwise requested by the customer.



# NEWcel® FOAMED DIELECTRICS

## TECHNICAL INFORMATION

Air is a near perfect dielectric medium allowing a signal to propagate through it at approximately the speed of light. However, an air dielectric is impractical for use as a cable insulation as it provides no structural integrity. Thus, manufacturers resort to using materials with higher dielectric constants (lower propagation velocity) to meet physical requirements.

NEWcel® is the perfect solution. A closed-cell foamed dielectric material specifically designed to reduce dielectric constant and dissipation factor yielding low-capacitance, low-loss, high V.O.P. ultraminiature coaxial, triaxial and twinaxial cables.

Typical coaxial, triaxial and twinaxial cables are manufactured using low dielectric constant (2.0 - 2.6) materials that possess inherently better electrical properties than standard insulation material such as PVC. Using highly controlled extrusion processes, these materials are foamed yielding a dielectric medium with a high air concentration. The result of this process is a significantly reduced dielectric constant (1.45 - 1.8) that approaches the nearly ideal properties of air without sacrificing structural integrity. This results in a significant capacitance reduction while providing the customer with the choice of reduced diameter/same attenuation or same diameter/reduced attenuation.

### MATERIAL PROPERTIES

Property	-B04	-B05	-GX20	-GX16
Temperature Rating	80° C	80° C	150° C	200° C
Dielectric Constant	1.80	1.60	1.60	1.45
Propagation Velocity	74.5%	79.0%	79.0%	82.5%

## PRODUCT ADVANTAGES

- \* Reduces Attenuation
- \* Reduces Cable Size
- \* Reduces Capacitance
- \* Wide Temperature Range

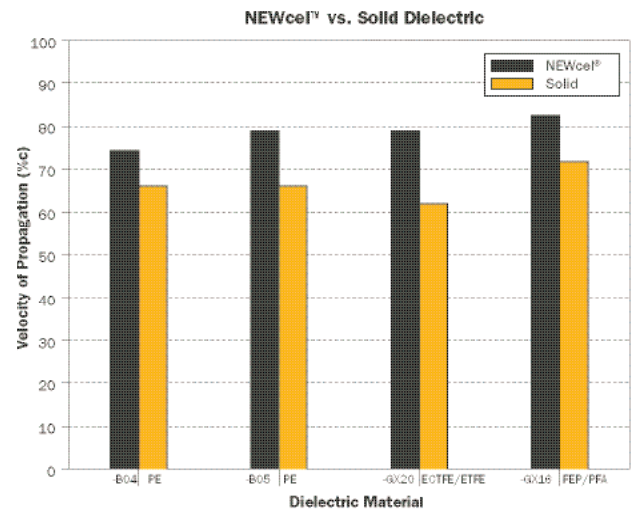

A comparison of the propagation velocity of a signal through NEWcel® and equivalent solid dielectric materials.

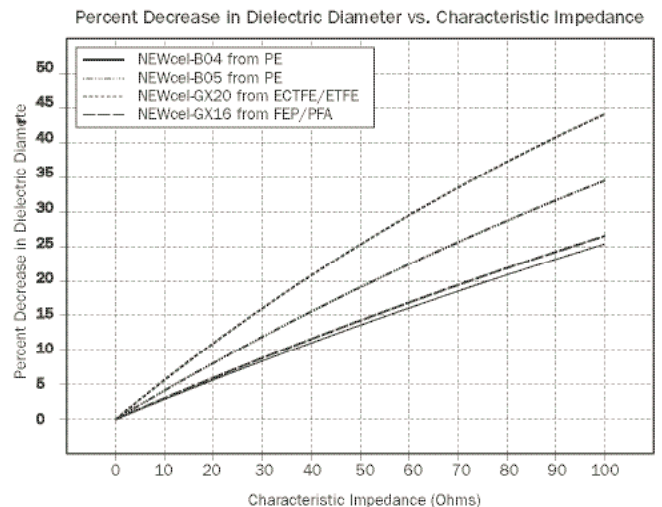

An estimated percent decrease in dielectric diameter resulting from switching to NEWcel® from equivalent solid dielectric materials if the characteristic impedance is constant.

www.newenglandwire.com

Tel: 603.838.6624





## POWER LEADS/FLEXIBLE INTERCONNECT CABLES

Power leads and flexible interconnect wires play a vital role in today's electrical and electronic applications. New England Wire Technologies manufactures a broad selection of single and multiconductor designs for general and special purpose applications.

Our specialty flexible interconnects combine our ultra fine-wire stranding technology with thin walls of nylon, polyethylene, polyurethane, polypropylene, polyester, silicone rubber, PVC, FEP, ETFE, PFA, and TPE. These are used in speaker interconnects, biomedical instruments, computers, and other products requiring miniature conductors with superior flexibility.

New England Wire's general-purpose power leads and flexible interconnect wires can be manufactured using a range of wire gauge sizes, strand constructions, conductor materials, wall thicknesses, shields and jackets.

We are a world leader in the manufacture of custom ultra-flexible interconnects offering conductor sizes from microminiature up to 250 MCM. These include a range of ropelay constructions using bare as well as tinned-, silver- or nickel-plated copper, and high-strength alloys. Power distribution applications demand wire products with the uncompromising quality and maximum flexibility that New England Wire Technologies delivers.



## POWER LEADS/FLEXIBLE INTERCONNECT CABLES

For power distribution applications that require high temperature wire with maximum flexibility, New England Wire Technologies has single and multiconductor cables available in sizes up to 250 MCM. Our flexible interconnects are commonly supplied in UL and CSA recognized PVC insulated constructions, but these conductors can also be insulated with silicone rubbers, polyester, polyurethanes or TPEs.

In addition, New England Wire Technologies has developed special-use, proprietary power cables. Hyflex™ Power Distribution cables are specifically engineered to handle the high voltage and temperatures inherent with today's diesel hybrid vehicles. Independently tested to meet the requirements of SAE J 1654 and 1127, Hyflex™ cables are rated for use at 125° C and up to 600 volts.

COLDflex Ground Cables™ were developed using a high performance compound specifically formulated for flexibility in power distribution applications during cold weather...down to -40° C, is UV resistant and has an operating voltage up to 5kV.

Extra Flexible Silicone Rubber Grounding . . . .	105	FEP Lead Wire - 300 Volts . . . . .	114
Extra Flexible PVC - 300 Volts . . . . .	106	FEP Lead Wire - 600 Volts . . . . .	115
Extra Flexible PVC - 300 Volts . . . . .	106	FEP Lead Wire - 1000 Volts . . . . .	116
Ultra Flexible Miniature Silicone Rubber . . . .	107	UL 1007 PVC . . . . .	117
Extra Flexible Silicone Rubber Lead - 600 Volt . . . . .	108	UL 1015 PVC . . . . .	118
Extra Flexible Silicone Rubber Lead - 1000 Volt . . . . .	109	UL 1032 PVC . . . . .	119
Ultra Flexible Micro & Miniature PVC . . . . .	110	UL 1662 PVC . . . . .	120
Extra Flexible PVC Lead - 600 Volts . . . . .	111	UL 3123 Silicone Rubber . . . . .	121
PVC Lead - 1000 Volts . . . . .	112	UL 3132 Silicone Rubber . . . . .	122
PVC Lead - 3000 Volts . . . . .	112	Hyflex™ Power Distribution Cables . . . . .	123
Ultra Flexible Microminiature FEP 150 V . . . .	113	COLDflex Ground Cables™ . . . . .	124
		PVC Ground Strap . . . . .	125



# Extra Flexible Silicone Rubber Grounding/Power Cables 600 Volt, 150° C UL, VW-1 Rated

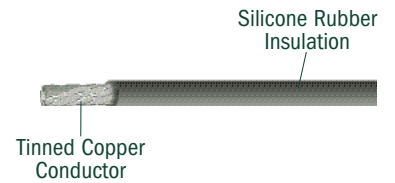

**DESCRIPTION:** Tinned-copper conductors insulated with silicone rubber.

**USE:** Ground strap lead wire for internal wiring of electronic equipment where acceptability of the combination is to be determined by UL, Inc.

UL Style	CONDUCTOR				Cable OD	Minimal Wall Thickness	Nominal OD
	Equivalent AWG Size	Number of Strands	AWG of Strand	Construction			
3212	22	26	36	26/36	.029	.052	.133
3212	20	42	36	42/36	.037	.052	.141
3212	18	65	36	65/36	.047	.052	.151
3212	18	63	36	7x9/36	.049	.052	.153
3212	16	105	36	7x15/36	.063	.052	.167
3212	14	168	36	7x24/36	.082	.052	.184
3212	12	259	36	7x37/36	.099	.052	.203
3212	10	413	36	7x59/36	.126	.052	.230

UL Style	CONDUCTOR				Cable OD	Minimal Wall Thickness	Nominal OD
	Equivalent AWG Size	Number of Strands	AWG of Strand	Construction			
3213	8	665	36	7x95/36	.159	.070	.299
3213	7	833	36	7x119/36	.178	.070	.318
3213	6	1050	36	7x150/36	.200	.070	.340
3213	5	1323	36	7x7x27/36	.242	.070	.382
3213	4	1666	36	7x7x34/36	.271	.070	.411
3213	3	2107	36	7x7x43/36	.305	.070	.445
3213	2	2646	36	7x7x54/36	.342	.070	.482

UL Style	CONDUCTOR				Cable OD	Minimal Wall Thickness	Nominal OD
	Equivalent AWG Size	Number of Strands	AWG of Strand	Construction			
3214	1	3332	36	7x7x68/36	.383	.086	.555
3214	1/0	4214	36	7x7x86/36	.431	.086	.603
3214	2/0	5292	36	7x7x108/36	.483	.086	.655
3214	3/0	6783	36	19x7x51/36	.547	.086	.719
3214	4/0	8512	36	19x7x64/36	.613	.086	.785

Our standard colors for primary and overall jackets include: white, black, red, green, yellow, blue, brown, orange, gray and violet. Custom color and/or exact color match available; please contact our design team for your specific requirement.

*All measurements are in inches unless otherwise stated.*

[www.newenglandwire.com](http://www.newenglandwire.com)  
Tel: 603.838.6624

# Extra Flexible PVC Insulated Power Cables 300 Volts, 105° C

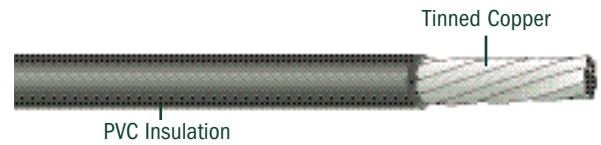

UL 10198, CSA Approved, VW-1 Rated

USE: UL10198 - Ground strap lead wire for internal wiring of electronic equipment where acceptability of the combination is to be determined by UL, Inc.

Stocked Item*	New England Part Number	Equivalent AWG Size	Construction	Number of Strands	Strand AWG Size	Cable OD <sup>2</sup>	Minimal Wall Thickness	Nominal OD
	N20-36T-467-R01-X <sup>1</sup> UC	18	65/36	65	36	.047	.015	.080
	N20-36T-417-R01-X <sup>1</sup> UC	18	7x9/36	63	36	.049	.015	.083
	N20-36T-510-R01-X <sup>1</sup> UC	16	7x15/36	105	36	.063	.015	.098
	N30-36T-569-R01-X <sup>1</sup> UC	14	7x24/36	168	36	.080	.020	.126
B	N30-36T-622-R01-X <sup>1</sup> UC	12	7x37/36	259	36	.099	.020	.146
B,R	N30-36T-673-X <sup>1</sup> UC	10	7x59/36	413	36	.126	.020	.173
B,R	N30-36T-737-X <sup>1</sup> UC	8	7x95/36	665	36	.159	.030	.235
	N30-36T-739-X <sup>1</sup> UC	7	7x119/36	833	36	.178	.030	.249
B	N30-36T-775-X <sup>1</sup> UC	6	7x150/36	1050	36	.200	.030	.272
B	N30-36T-776-X <sup>1</sup> UC	4	7x7x34/36	1666	36	.271	.030	.349
	N30-36T-815-X <sup>1</sup> UC	2	7x7x54/36	2646	36	.342	.030	.422
	N30-36T-814-X <sup>1</sup> UC	1	7x7x68/36	3332	36	.383	.040	.488
B	N30-36T-857-X <sup>1</sup> UC	1/0	7x7x86/36	4214	36	.431	.040	.538
B	N30-36T-870-X <sup>1</sup> UC	2/0	7x7x108/36	5292	36	.483	.050	.614
	N30-36T-905-X <sup>1</sup> UC	3/0	19x7x51/36	6783	36	.547	.060	.679
	N30-36T-960-X <sup>1</sup> UC	4/0	19x7x64/36	8512	36	.613	.080	.789

# Extra Flexible PVC Insulated Power Cables 600 Volts, 105° C

\*STOCKED ITEMS: B = Black jacket w/white print  
R = Red jacket w/white print  
W = White jacket w/black print

UL 10070, CSA Approved, VW-1 Rated

USE: Internal wiring of computers and electronic equipment.

Stocked Item*	New England Part Number	Equivalent AWG Size	Construction	Number of Strands	Strand AWG Size	Cable OD <sup>2</sup>	Minimal Wall Thickness	Nominal OD
	N30-36T-459-R01-X <sup>1</sup> UC	18	65/36	65	36	.047	.030	.113
	N30-36T-417-R01-X <sup>1</sup> UC	18	7x9/36	63	36	.049	.030	.116
	N30-36T-516-R01-X <sup>1</sup> UC	16	7x15/36	105	36	.063	.030	.131
B,W	N30-36T-566-R01-X <sup>1</sup> UC	14	7x24/36	168	36	.082	.030	.148
B,R	N30-36T-617-R01-X <sup>1</sup> UC	12	7x37/36	259	36	.099	.030	.168
B,W,R	N30-36T-669-X <sup>1</sup> UC	10	7x59/36	413	36	.126	.030	.195
B	N30-36T-731-X <sup>1</sup> UC	8	7x95/36	665	36	.159	.045	.263
	N40-36T-713-X <sup>1</sup> UC	7	7x119/36	833	36	.178	.060	.315
B	N40-36T-767-X <sup>1</sup> UC	6	7x150/36	1050	36	.200	.060	.338
B	N40-36T-764-R01-X <sup>1</sup> UC	4	7x7x34/36	1666	36	.271	.060	.415
B	N40-36T-822-X <sup>1</sup> UC	2	7x7x54/36	2646	36	.342	.060	.488
	N40-36T-823-X <sup>1</sup> UC	1	7x7x68/36	3332	36	.383	.080	.576
	N40-36T-869-X <sup>1</sup> UC	1/0	7x7x86/36	4214	36	.431	.080	.626
	N40-36T-871-X <sup>1</sup> UC	2/0	7x7x108/36	5292	36	.483	.080	.680
	N40-36T-906-X <sup>1</sup> UC	3/0	19x7x51/36	6783	36	.547	.080	.723
	N40-36T-961-X <sup>1</sup> UC	4/0	19x7x64/36	8512	36	.613	.080	.789

- PVC colors designated by numbered suffix in place of the first "X" in the above part numbers: 1 - white; 2 - black; 3 - red; 4 - green; 5 - yellow; 6 - blue; 7 - brown; 8 - orange; 9 - gray; 10 - violet
- The uninsulated cable diameter is determined when the cable is under tension during the extrusion process. Please request a sample of our cable for evaluation prior to making decisions regarding connectors to be used.
- Cable printed in white or black.

All measurements are in inches unless otherwise stated.



NEW ENGLAND WIRE TECHNOLOGIES  
Innovate. Create. Accelerate.

# Ultra Flexible Miniature Silicone Rubber Lead Wire 300 Volt, 150° C



**DESCRIPTION:** Ultra flexible stranded bare copper or silver-plated copper conductor insulated with a 10 mil wall of extruded silicone rubber providing ultimate flexibility.

**USE:** Various medical and general electronic equipment where long flex-life and maximum flexibility are required. Recommended for some industrial applications where higher temperature ratings are required. Please contact our design team for your specific requirements.

Equivalent Gauge	CONDUCTOR INFORMATION					Nominal Wall Thickness	Nominal Outside Diameter
	Construction	Circular Mil Area	Number of Strands	AWG of Strand	Conductor Diameter		
36	26/50	26.0	26	50	.006	.010	.026
36	10/46	25.6	10	46	.006	.010	.026
36	7/44	28.0	7	44	.006	.010	.026
34	41/50	41.0	41	50	.007	.010	.027
34	16/46	41.0	16	46	.007	.010	.027
34	10/44	40.0	10	44	.007	.010	.027
32	65/50	365.0	65	50	.009	.010	.029
32	26/46	66.6	26	46	.009	.010	.029
32	16/44	64.0	16	44	.009	.010	.029
30	7/40	67.3	7	40	.009	.010	.029
30	41/46	105.0	41	46	.012	.010	.032
28	25/44	100.0	25	44	.012	.010	.032
28	65/46	166.4	65	46	.015	.010	.035
28	40/44	160.0	40	44	.015	.010	.035
28	19/40	182.6	19	40	.015	.010	.035
26	66/44	264.0	66	46	.019	.010	.039
26	26/40	249.9	26	44	.018	.010	.038
24	3x35/44	420.0	105	44	.025	.010	.045
24	42/40	403.6	42	40	.023	.010	.043

Our standard colors for primary and overall jackets include: white, black, red, green, yellow, blue, brown, orange, gray and violet. Custom color and/or exact color match available; please contact our design team for your specific requirement.

*All measurements are in inches unless otherwise stated.*

[www.newenglandwire.com](http://www.newenglandwire.com)  
Tel: 603.838.6624

# Extra Flexible Silicone Rubber Lead Wire 600 Volts, 150° C



**DESCRIPTION:** Stranded tin or silver plated copper conductor insulated with a 16 mil wall of extruded silicone rubber.

**USE:** High temperature military and commercial applications where flexibility and long service life are important. Offers superior electrical properties under severe service and environmental conditions.

Equivalent AWG Size	Construction	CONDUCTOR			Nominal Conductor Diameter	Nominal Wall Thickness	Nominal OD
		Circular Mil Area	Number of Strands	AWG of Strands			
32	16/44	64.0	16	44	.009	.016	.041
32	7/40	67.2	7	40	.009	.016	.041
30	41/46	104.9	41	46	.012	.016	.044
30	25/44	100.0	25	44	.012	.016	.044
30	19/42	118.7	19	42	.012	.016	.044
30	7/38	112.0	7	38	.012	.016	.044
29	52/46	133.1	52	46	.013	.016	.045
28	65/46	166.4	65	46	.015	.016	.047
28	40/44	160.0	40	44	.015	.016	.047
28	19/40	182.5	19	40	.015	.016	.047
28	7/36	175.0	7	36	.015	.016	.047
26	66/44	264.0	66	44	.019	.016	.051
26	26/40	249.8	26	40	.018	.016	.050
26	19/38	304.0	19	38	.019	.016	.051
26	7/34	277.8	7	34	.019	.016	.051
24	3x35/44	420.0	105	44	.025	.016	.057
24	42/40	403.6	42	40	.023	.016	.055
24	19/36	475.0	19	36	.024	.016	.056
24	7/32	448.0	7	32	.024	.016	.056
23	3x50/44	600.0	150	44	.030	.016	.062
22	66/40	634.2	66	40	.031	.016	.063
22	26/36	650.0	26	36	.029	.016	.061
22	19/34	754.1	19	34	.030	.016	.062
22	7/30	700.0	7	30	.030	.016	.062
20	7x37/44	1036.0	259	44	.040	.016	.072
20	7x15/40	1009.0	105	40	.039	.016	.071
20	42/36	1050.0	42	36	.037	.016	.069
20	10/30	1000.0	10	30	.037	.016	.069
20	19/32	1216.0	19	32	.038	.016	.070
18	7x59/44	1652.0	413	44	.050	.016	.082
18	7x24/40	1614.4	168	40	.050	.016	.082
18	65/36	1625.0	65	36	.047	.016	.079

Our standard colors for primary and overall jackets include: white, black, red, green, yellow, blue, brown, orange, gray and violet. Custom color and/or exact color match available; please contact our design team for your specific requirement.

*All measurements are in inches unless otherwise stated.*

# Silicone Rubber Insulated Lead Wire 1000 Volts, 150° C

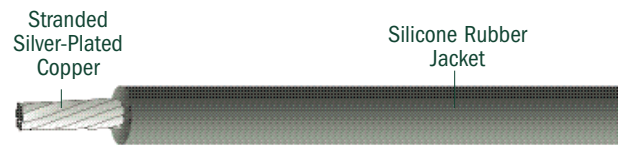

**DESCRIPTION:** Stranded silver-plated copper conductor insulated with extruded silicone rubber jacket.

**USE:** High temperature military and commercial applications where flexibility and long service life are important. Offers superior electrical properties under severe service and environmental conditions. Please contact our design team for your specific requirements

Equivalent AWG Size	Construction	CONDUCTOR					Nominal Wall Thickness	Nominal OD
		Circular Mil Area	Number of Strands	AWG of Strands	Nominal Conductor Diameter			
32	65/50	65.0	65	50	.009	.030	.069	
32	26/46	66.5	26	46	.009	.030	.069	
32	19/44	76.0	19	44	.010	.030	.070	
32	7/40	67.2	7	40	.009	.030	.069	
30	41/46	104.9	41	46	.012	.030	.072	
30	19/42	118.7	19	42	.012	.030	.072	
30	7/38	112.0	7	38	.012	.030	.072	
28	65/46	166.4	65	46	.015	.030	.075	
28	19/40	182.5	19	40	.015	.030	.075	
28	7/36	175.0	7	36	.015	.030	.075	
28	7/34	277.8	7	34	.019	.031	.081	
26	66/44	264.0	66	44	.019	.031	.081	
26	19/38	304.0	19	38	.019	.031	.081	
24	42/40	403.6	42	40	.023	.031	.085	
24	19/36	475.0	19	36	.024	.031	.086	
24	7/32	448.0	7	32	.024	.031	.086	
22	66/40	634.2	66	40	.029	.031	.091	
22	19/34	754.1	19	34	.030	.031	.092	
22	7/30	700.0	7	30	.030	.031	.092	
20	42/36	1050.0	42	36	.037	.031	.099	
20	19/32	1216.0	19	32	.038	.031	.100	
18	65/36	1625.1	65	36	.047	.031	.109	
18	19/30	1900.0	19	30	.048	.031	.110	

Our standard colors for primary and overall jackets include: white, black, red, green, yellow, blue, brown, orange, gray and violet. Custom color and/or exact color match available; please contact our design team for your specific requirement.

*All measurements are in inches unless otherwise stated.*

[www.newenglandwire.com](http://www.newenglandwire.com)  
Tel: 603.838.6624

# Ultra Flexible Microminiature & Miniature PVC Insulated Lead Wire 200 Volts, 105° C



**DESCRIPTION:** Ultra flexible stranded bare copper conductor insulated with a 5 mil wall of extruded PVC providing ultimate flexibility in a microminiature hook up wire. Temperature rating to 105°C. Voltage rating 300 volts. Resistant to acids, oils, alkalies, flame, solvents and moisture. Most items also available using tinned copper stranding.

**USE:** Gyroscopes, medical instruments, measurement and test equipment and other specialized applications where ultra flexibility is required in a microminiature insulated conductor.

## Ultra Flexible Microminiature PVC Insulated Lead Wire

Equivalent AWG	CONDUCTOR INFORMATION				Nominal Wall Thickness	Nominal OD
	Circular Mil Area	Number of Wires	AWG of Wire	Conductor Diameter		
38	16.0	17	50	.005	.005	.015
38	17.9	7	46	.005	.005	.015
36	25.0	26	50	.006	.005	.016
36	28.0	7	44	.006	.005	.016
34	40.0	41	50	.007	.005	.017
34	40.0	10	44	.007	.005	.017
34	43.8	7	42	.008	.005	.018

## Ultra Flexible Miniature PVC Insulated Lead Wire

Equivalent AWG	CONDUCTOR INFORMATION				Nominal Wall Thickness	Nominal OD
	Circular Mil Area	Number of Wires	AWG of Wire	Conductor Diameter		
32	65.0	65	50	.009	.005	.019
32	64.0	26	46	.009	.005	.019
32	64.0	16	44	.009	.005	.019
32	67.3	7	40	.009	.005	.019
30	102.0	41	46	.012	.005	.022
30	100.0	25	44	.012	.005	.022
30	96.1	11	40	.012	.005	.022
30	112.0	7	38	.012	.005	.022

Our standard colors for primary and overall jackets include: white, black, red, green, yellow, blue, brown, orange, gray and violet. Custom color and/or exact color match available; please contact our design team for your specific requirement.

*All measurements are in inches unless otherwise stated.*



NEW ENGLAND WIRE TECHNOLOGIES  
Innovate. Create. Accelerate.

# Extra Flexible Miniature PVC Insulated Lead Wire 600 Volts, 105° C

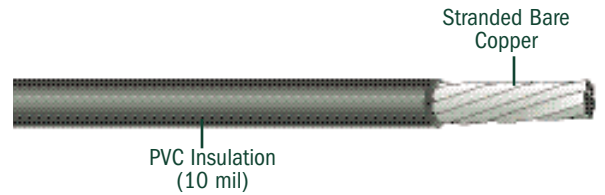

**DESCRIPTION:** Extra flexible stranded bare copper conductor insulated with a 10 mil wall of extruded PVC. Resistant to acids, oils, alkalis, solvents and flame. Most constructions also available with tinned copper stranding.

**USE:** Useful in various medical instruments as well as other electronic applications requiring a miniature, extra-flexible conductor. Please call our design team to assist with your specific application.

Equivalent AWG	CONDUCTOR INFORMATION					Nominal Wall Thickness	Nominal OD
	Construction	Circular Mil Area	Number of Wires	AWG of Wire	Conductor Diameter		
38	7/46	17.9	7	46	.005	.010	.025
36	11/46	28.1	11	46	.006	.010	.026
36	7/44	28.0	7	44	.006	.010	.026
34	16/46	41.0	16	46	.007	.010	.027
34	10/44	40.0	10	44	.007	.010	.027
34	5/40	48.0	5	40	.008	.010	.028
32	26/46	66.5	26	46	.009	.010	.029
32	16/44	64.0	16	44	.009	.010	.029
32	7/40	67.2	7	40	.009	.010	.029
30	41/46	104.9	41	46	.012	.010	.032
30	25/44	100.0	25	44	.012	.010	.032
30	7/38	112.0	7	38	.012	.010	.032
29	52/46	133.1	52	46	.013	.010	.033
28	65/46	166.4	65	46	.015	.010	.035
28	40/44	160.0	40	44	.015	.010	.035
28	19/40	182.5	19	40	.015	.010	.035
26	7x15/46	420.0	105	44	.020	.010	.040
26	3x35/46	420.0	105	46	.020	.010	.040
26	3x22/44	420.0	66	44	.020	.010	.040
26	66/44	264.0	66	44	.019	.010	.039
26	26/40	249.8	26	40	.018	.010	.038
26	19/38	304.0	19	38	.019	.010	.039
24	3x35/44	600.0	105	44	.025	.010	.045
24	7x15/44	420.0	105	44	.025	.010	.045
24	42/40	403.6	42	40	.023	.010	.043
24	19/36	475.0	19	36	.024	.010	.044
23	3x50/44	600.0	150	44	.030	.010	.050
22	7x24/44	672.0	168	44	.032	.010	.052
22	66/40	634.2	66	40	.029	.010	.049
22	26/36	650.0	26	36	.029	.010	.049
20	7x37/44	1036.0	259	44	.040	.010	.060
20	7x15/40	1009.0	105	40	.039	.010	.059
20	42/36	1050.0	42	36	.037	.010	.057
18	7x59/44	1652.0	413	44	.050	.010	.070
18	7x24/40	1615.0	168	40	.050	.010	.070

Our standard colors for primary and overall jackets include: white, black, red, green, yellow, blue, brown, orange, gray and violet. Custom color and/or exact color match available; please contact our design team for your specific requirement.

*All measurements are in inches unless otherwise stated.*

[www.newenglandwire.com](http://www.newenglandwire.com)  
Tel: 603.838.6624

# PVC Insulated Lead Wire 1000 Volts, 105° C

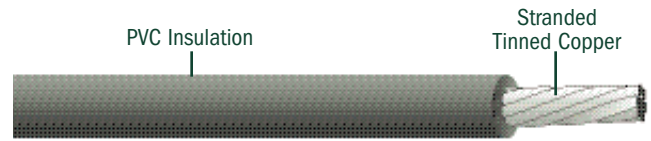

**DESCRIPTION:** Stranded tin-plated copper conductor insulated with a 17 mil nominal wall of extruded PVC which is resistant to water, oils, acids, solvents and is self-extinguishing.

**USE:** General Purpose hook-up wire. Please call our design team for your specific requirement.

Equivalent AWG Size	CONDUCTOR				Nominal Conductor Diameter	Nominal Wall Thickness	Nominal OD
	Construction	Circular Mil Area	Number of Strands	AWG of Strands			
28	19/40	183	19	440	.015	.017	.049
28	7/36	175	7	36	.015	.017	.049
26	19/38	304	19	38	.019	.017	.053
26	7/34	278	7	34	.019	.017	.053
24	19/36	475	19	36	.024	.017	.058
24	7/32	448	7	32	.024	.017	.058
22	19/34	754	19	34	.030	.017	.064
22	7/30	700	7	30	.030	.017	.064
20	19/32	1216	19	32	.038	.017	.072
18	19/30	1900	19	30	.048	.017	.082

# PVC Insulated Lead Wire 3000 Volts, 105° C



**Stranded tin-plated copper conductor insulated with a 29 mil wall of extruded PVC which is resistant to water, oils, acids, solvents and is self-extinguishing.**

**General purpose electronic hook-up wire. Please call our design team for your specific requirement.**

Equivalent AWG Size	CONDUCTOR				Nominal Conductor Diameter	Nominal Wall Thickness	Nominal OD
	Construction	Circular Mil Area	Number of Strands	AWG of Strands			
26	19/38	304	19	38	.019	.029	.077
26	7/34	278	7	34	.019	.029	.077
24	19/36	475	19	36	.024	.029	.082
24	7/32	448	7	32	.024	.029	.082
22	19/34	754	19	34	.030	.029	.088
22	7/30	700	7	30	.030	.029	.088
20	19/32	1216	19	32	.038	.029	.096
18	19/30	1900	19	30	.048	.029	.106

Our standard colors for primary and overall jackets include: white, black, red, green, yellow, blue, brown, orange, gray and violet. Custom color and/or exact color match available; please contact our design team for your specific requirement.

*All measurements are in inches unless otherwise stated.*



# Ultra Flexible Microminiature FEP Insulated Lead Wire 150 Volts, 150° C



**DESCRIPTION:** Ultra flexible stranded bare copper conductor insulated with a 3.5 mil wall of clear, non-hygroscopic fluoropolymer (FEP).

\*When using silver-plated copper strand this item is rated for 200° C.

**USE:** Critical physiological applications where small diameters, long flex-life and non-toxic insulations are of primary consideration. Designed for long usage in flow probes and pressure measuring instruments. Please call our design team for your specific application.

CONDUCTOR INFORMATION						
Equivalent Gauge	Circular Mil Area	Number of Strands	AWG of Strand	Conductor Diameter	Nominal Wall Thickness	Nominal OD
42	7.00	7	50	.003	.0035	.010
40	10.00	10	50	.004	.0035	.011
40	10.08	7	48	.004	.0035	.011
38	17.00	17	50	.005	.0035	.012
38	17.92	7	46	.005	.0035	.012
36	26.00	26	50	.006	.0035	.013
36	27.36	19	48	.006	.0035	.013
34	41.00	41	50	.007	.0035	.014
34	40.96	16	46	.007	.0035	.014
33	52.00	52	50	.008	.0035	.015
32	65.00	65	50	.009	.0035	.016
32	66.56	26	46	.009	.0035	.016
31	75.00	75	50	.010	.0035	.017
30	104.96	41	46	.012	.0035	.019
29	133.12	52	46	.013	.0035	.020
28	166.40	65	46	.015	.0035	.022

Our standard colors for primary and overall jackets include: white, black, red, green, yellow, blue, brown, orange, gray and violet. Custom color and/or exact color match available; please contact our design team for your specific requirement.

*All measurements are in inches unless otherwise stated.*

[www.newenglandwire.com](http://www.newenglandwire.com)  
Tel: 603.838.6624

# FEP Insulated Lead Wire 300 Volts, 200° C



**DESCRIPTION:** Stranded silver-plated copper conductor insulated with a 6 mil wall of extruded FEP.

**USE:** General purpose high temperature hook-up wire offering excellent chemical, moisture and abrasion resistance, in addition to superior dielectric properties up to 200°C. Please contact our design team to discuss your specific application.

Equivalent AWG Size	CONDUCTOR				Nominal Conductor Diameter	Nominal Wall Thickness	Nominal OD
	Circular Mil Area	Construction	Number of Strands	AWG of Strands			
36	26.0	26/50	26	50	.006	.006	.018
36	28.2	11/46	11	46	.006	.006	.018
36	28.0	7/44	7	44	.006	.006	.018
34	41.0	41/50	41	50	.007	.006	.019
34	40.9	16/46	16	46	.007	.006	.019
34	40.0	10/44	10	44	.007	.006	.019
32	65.0	65/50	65	50	.009	.006	.021
32	66.6	26/46	26	46	.009	.006	.021
32	64.0	16/44	16	44	.009	.006	.021
30	104.9	41/46	41	46	.012	.006	.024
30	100.0	25/44	25	44	.012	.006	.024
30	118.8	19/42	19	42	.012	.006	.024
30	112.0	7/38	7	38	.012	.006	.024
29	113.1	52/46	52	46	.013	.006	.025
28	166.4	65/46	65	46	.015	.006	.027
28	160.0	40/44	40	44	.015	.006	.027
28	182.6	19/40	19	40	.015	.006	.027
28	175.0	7/36	7	36	.015	.006	.027
26	277.8	66/44	66	44	.019	.006	.031
26	304.0	19/38	19	38	.019	.006	.031
26	264.0	7/34	7	34	.019	.006	.031
24	420.0	7x15/44	105	44	.025	.006	.037
24	475.0	42/40	42	40	.024	.006	.036
24	403.6	19/36	19	36	.023	.006	.035
22	672.0	7x24/44	168	44	.032	.006	.044
22	634.3	66/40	66	40	.029	.006	.042
22	754.1	19/34	19	34	.030	.006	.042
20	1009.0	7x15/40	105	40	.039	.006	.051
20	1050.0	42/36	42	36	.037	.006	.049

Our standard colors for primary and overall jackets include: white, black, red, green, yellow, blue, brown, orange, gray and violet. Custom color and/or exact color match available; please contact our design team for your specific requirement.

All measurements are in inches unless otherwise stated.



# FEP Insulated Lead Wire 600 Volts, 200° C



**DESCRIPTION:** Stranded silver-plated copper conductor insulated with a 10 mil wall of FEP.

**USE:** General purpose high temperature hook-up wire offering excellent chemical, moisture and abrasion resistance, in addition to superior dielectric properties up to 200°C.

Equivalent AWG Size	CONDUCTOR				Nominal Conductor Diameter	Nominal Wall Thickness	Nominal OD
	Circular Mil Area	Construction	Number of Strands	AWG of Strands			
36	26.0	26/50	26	50	.006	.010	.026
36	28.2	11/46	11	46	.006	.010	.026
36	28.0	7/44	7	44	.006	.010	.026
34	41.0	41/50	41	50	.007	.010	.027
34	40.9	16/46	16	46	.007	.010	.027
34	40.0	10/44	10	44	.007	.010	.027
32	65.0	65/50	65	50	.009	.010	.029
32	66.6	26/46	26	46	.009	.010	.029
32	64.0	16/44	16	44	.009	.010	.029
30	104.9	41/46	41	46	.012	.010	.032
30	100.0	25/44	25	44	.012	.010	.032
30	118.8	19/42	19	42	.012	.010	.032
30	112.0	7/38	7	38	.012	.010	.032
29	113.1	52/46	52	46	.013	.010	.033
28	166.4	65/46	65	46	.015	.010	.035
28	160.0	40/44	40	44	.015	.010	.035
28	182.6	19/40	19	40	.015	.010	.035
28	175.0	7/36	7	36	.015	.010	.035
26	277.8	66/44	66	44	.019	.010	.039
26	304.0	19/38	19	38	.019	.010	.039
26	264.0	7/34	7	34	.019	.010	.039
24	420.0	7x15/44	105	44	.025	.010	.045
24	475.0	42/40	42	40	.024	.010	.044
24	403.6	19/36	19	36	.023	.010	.043
22	672.0	7x24/44	168	44	.032	.010	.050
22	634.3	66/40	66	40	.029	.010	.049
22	754.1	19/34	19	34	.030	.010	.050
20	1009.0	7x15/40	105	40	.039	.010	.059
20	1050.0	42/36	42	36	.037	.010	.057

Our standard colors for primary and overall jackets include: white, black, red, green, yellow, blue, brown, orange, gray and violet. Custom color and/or exact color match available; please contact our design team for your specific requirement.

*All measurements are in inches unless otherwise stated.*

[www.newenglandwire.com](http://www.newenglandwire.com)  
Tel: 603.838.6624

# FEP Insulated Lead Wire 1000 Volts, 200° C



**DESCRIPTION:** Stranded silver-plated copper conductor insulated with a 15 mil wall of extruded FEP.

**USE:** General purpose high temperature hook-up wire offering excellent chemical, moisture and abrasion resistance, in addition to superior dielectric properties up to 200°C. Please contact our design team for your specific application.

Equivalent AWG Size	CONDUCTOR						Nominal Wall Thickness	Nominal OD
	Circular Mil Area	Construction	Number of Strands	AWG of Strands	Nominal Conductor Diameter			
32	65.0	65/50	65	50	.009	.015	.039	
32	66.5	26/46	26	46	.009	.015	.039	
32	76.0	19/44	19	44	.010	.015	.040	
32	67.2	7/40	7	40	.009	.015	.039	
30	104.9	41/46	41	46	.012	.015	.042	
30	118.7	19/42	19	42	.012	.015	.042	
30	112.0	7/38	7	38	.012	.015	.042	
28	166.4	65/46	65	46	.015	.015	.045	
28	182.5	19/40	19	40	.015	.015	.045	
28	175.0	7/36	7	36	.015	.015	.045	
26	264.0	66/44	66	44	.019	.015	.049	
26	304.0	19/38	19	38	.019	.015	.049	
26	277.8	7/34	7	34	.019	.015	.049	
24	403.6	42/40	42	40	.023	.015	.053	
24	475.0	19/36	19	36	.024	.015	.054	
24	448.0	7/32	7	32	.024	.015	.054	
22	634.2	66/40	66	40	.029	.015	.059	
22	754.1	19/34	19	34	.030	.015	.060	
22	700.0	7/30	7	30	.030	.015	.060	
20	1050.0	42/36	42	36	.037	.015	.067	
20	1216.0	19/32	19	32	.038	.015	.068	
18	1900.0	19/30	19	30	.048	.015	.078	
18	1625.0	65/36	65	36	.047	.015	.077	

Our standard colors for primary and overall jackets include: white, black, red, green, yellow, blue, brown, orange, gray and violet. Custom color and/or exact color match available; please contact our design team for your specific requirement.

*All measurements are in inches unless otherwise stated.*

# UL Style 1007 PVC Insulated Lead Wire 300 Volt, 80° C



**DESCRIPTION:** 32 - 16 AWG tin-plated copper conductor insulated with a 16 mil wall of PVC. Resistant to moisture, oil, solvents, and is self-extinguishing.

**USE:** Appliance and electronic equipment hook-up wire.

Equivalent AWG Size	CONDUCTOR				Nominal Conductor Diameter	Nominal Wall Thickness	Nominal OD
	Circular Mil Area	Construction	Number of Strands	AWG of Strands			
32	65.0	65/50	65	50	.009	.016	.041
32	66.5	26/46	26	46	.009	.016	.041
32	76.0	19/44	19	44	.010	.016	.042
32	67.2	7/40	7	40	.009	.016	.041
30	104.9	41/46	41	46	.012	.016	.044
30	118.7	19/42	19	42	.012	.016	.044
30	112.0	7/38	7	38	.012	.016	.044
28	166.4	65/46	65	46	.015	.016	.047
28	182.5	19/40	19	40	.015	.016	.047
28	175.0	7/36	7	36	.015	.016	.047
26	268.8	3x35/46	105	46	.020	.016	.052
26	264.0	66/44	66	44	.019	.016	.051
26	304.0	19/38	19	38	.019	.016	.051
26	277.8	7/34	7	34	.019	.016	.051
24	420.0	7x15/44	105	44	.025	.016	.057
24	403.6	42/40	42	40	.023	.016	.055
24	475.0	19/36	19	36	.024	.016	.056
24	448.0	7/32	7	32	.024	.016	.056
22	634.2	66/40	66	40	.029	.016	.061
22	754.1	19/34	19	34	.030	.016	.062
22	700.0	7/30	7	30	.030	.016	.062
20	1036.0	7x37/44	259	44	.040	.016	.072
20	1050.0	42/36	42	36	.037	.016	.069
20	1216.0	19/32	19	32	.038	.016	.070
18	1652.0	7x59/44	413	44	.050	.016	.082
18	1625.0	65/36	65	36	.047	.016	.079
18	1900.0	19/30	19	30	.048	.016	.080
16	2660.0	7x95/44	665	44	.064	.016	.096
16	2690.8	7x40/40	280	40	.064	.016	.096

Our standard colors for primary and overall jackets include: white, black, red, green, yellow, blue, brown, orange, gray and violet. Custom color and/or exact color match available; please contact our design team for your specific requirement.

*All measurements are in inches unless otherwise stated.*

[www.newenglandwire.com](http://www.newenglandwire.com)  
Tel: 603.838.6624

# UL Style 1015 PVC Insulated Lead Wire 600 Volt, 105° C

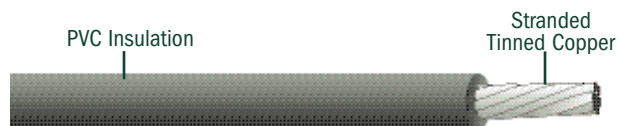

**DESCRIPTION:** 30 - 9 AWG tin-plated copper conductor insulated with 31 mil wall of PVC. Resistant to moisture, oil, solvents, and is self-extinguishing.

**USE:** Appliance and electronic equipment hook-up wire.

Equivalent AWG Size	CONDUCTOR						Nominal Wall Thickness	Nominal OD
	Circular Mil Area	Construction	Number of Strands	AWG of Strands	Nominal Conductor Diameter			
30	104	41/46	41	46	.012	.031	.074	
30	118	19/42	19	42	.012	.031	.074	
30	112	7/38	7	38	.012	.031	.074	
28	166	65/46	65	46	.015	.031	.077	
28	182	19/40	19	40	.015	.031	.077	
28	175	7/36	7	36	.015	.031	.077	
26	268	3x35/46	105	46	.020	.031	.082	
26	264	66/44	66	44	.019	.031	.081	
26	304	19/38	19	38	.019	.031	.081	
26	277	7/34	7	34	.019	.031	.081	
24	420	3x35/44	105	44	.025	.031	.087	
24	403	42/40	42	40	.023	.031	.085	
24	475	19/36	19	36	.024	.031	.086	
24	448	7/32	7	32	.024	.031	.086	
22	634	66/40	66	40	.029	.031	.091	
22	754	19/34	19	34	.030	.031	.092	
22	700	7/30	7	30	.030	.031	.092	
20	1036	7x37/44	259	44	.040	.031	.102	
20	1050	42/36	42	36	.037	.031	.099	
20	1216	19/32	19	32	.038	.031	.100	
18	1652	7x59/44	413	44	.050	.031	.112	
18	1625	65/36	65	36	.047	.031	.109	
18	1900	19/30	19	30	.048	.031	.110	
16	2660	7x95/44	665	44	.064	.031	.126	
16	2690	7x40/40	280	40	.064	.031	.126	
14	4200	7x3x50/44	1050	44	.082	.031	.144	
14	4238	7x3x21/40	441	40	.083	.031	.145	
14	4200	7x24/36	168	36	.080	.031	.142	
12	6664	7x7x34/44	1666	44	.108	.031	.170	
12	6458	7x96/40	672	40	.099	.031	.161	
12	6475	7x37/36	259	36	.099	.031	.161	
10	10325	7x59/36	413	36	.126	.031	.188	
10	10279	7x37/34	259	34	.125	.031	.187	
10	10500	7x15/30	105	30	.127	.031	.189	
9	13117	7x3x65/40	1365	40	.146	.031	.208	
9	13125	7x75/36	525	36	.142	.031	.204	
9	13300	7x19/30	133	30	.143	.031	.205	

Our standard colors for primary and overall jackets include: white, black, red, green, yellow, blue, brown, orange, gray and violet. Custom color and/or exact color match available; please contact our design team for your specific requirement.

*All measurements are in inches unless otherwise stated.*

# UL Style 1032 PVC Insulated Lead Wire 1000 Volt, 90° C

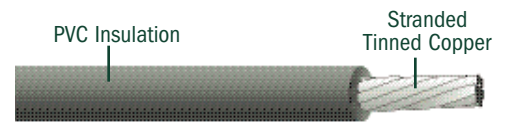

**DESCRIPTION:** 30 - 9 AWG tin-plated copper conductor insulated with a 31 mil wall of PVC. Resistant to moisture, oil, solvents, and is self-extinguishing.

**USE:** Appliance and electronic equipment hook-up wire.

Equivalent AWG Size	CONDUCTOR				Nominal Conductor Diameter	Nominal Wall Thickness	Nominal OD
	Circular Mil Area	Construction	Number of Strands	AWG of Strands			
30	104	41/46	41	46	.012	.031	.074
30	118	19/42	19	42	.012	.031	.074
30	112	7/38	7	38	.012	.031	.074
28	166	65/46	65	46	.015	.031	.077
28	182	19/40	19	40	.015	.031	.077
28	175	7/36	7	36	.015	.031	.077
26	268	3X35/46	105	46	.020	.031	.082
26	264	66/44	66	44	.019	.031	.081
26	304	19/38	19	38	.019	.031	.081
26	277	7/34	7	34	.019	.031	.081
24	420	3X35/44	105	44	.025	.031	.087
24	403	42/40	42	40	.023	.031	.0852
24	475	19/36	19	36	.024	.031	.086
24	448	7/32	7	32	.024	.031	.086
22	634	66/40	66	40	.029	.031	.091
22	754	19/34	19	34	.030	.031	.092
22	700	7/30	7	30	.030	.031	.092
20	1036	7X37/44	259	44	.040	.031	.102
20	1050	42/36	42	36	.037	.031	.099
20	1216	19/32	19	32	.038	.031	.100
18	1652	7x59/44	413	44	.050	.031	.112
18	1625	65/36	65	36	.047	.031	.109
18	1900	19/30	19	30	.048	.031	.110
16	2660	7x95/44	665	44	.064	.031	.126
16	2690	7x40/40	280	40	.064	.031	.126
14	4200	7x3x50/44	1050	44	.082	.031	.144
14	4238	7x3x21/40	441	40	.083	.031	.145
14	4200	7x24/36	168	36	.080	.031	.142
12	6664	7x7x34/44	1666	44	.108	.031	.170
12	6458	7x96/40	672	40	.099	.031	.161
12	6475	7x37/36	259	36	.099	.031	.161
10	10325	7x59/36	413	36	.126	.031	.188
10	10279	7x37/34	259	34	.125	.031	.187
10	10500	7x15/30	105	30	.127	.031	.189
9	13117	7x3x65/40	1365	40	.146	.031	.208
9	13125	7x75/36	525	36	.142	.031	.204
9	13300	7x19/30	133	30	.143	.031	.205

Our standard colors for primary and overall jackets include: white, black, red, green, yellow, blue, brown, orange, gray and violet. Custom color and/or exact color match available; please contact our design team for your specific requirement.

*All measurements are in inches unless otherwise stated.*

[www.newenglandwire.com](http://www.newenglandwire.com)  
Tel: 603.838.6624

# UL Style 1662 PVC Insulated Lead Wire 300 Volt, 80° C



**DESCRIPTION:** 30 AWG - 4/0 stranded tin-plated copper conductor insulated with PVC which is resistant to water, oil, acids, solvents and is self-extinguishing.

**USE:** Ground and lead wire for internal wiring of electronic equipment.

Equivalent AWG Size	CONDUCTOR					Nominal Conductor Diameter	Nominal Wall Thickness	Nominal OD
	Circular Mil Area	Construction	Number of Strands	AWG of Strands				
30	105	11/40	11	40	.012	.016	.044	
30	112	7/38	7	38	.012	.016	.044	
28	183	19/40	19	40	.015	.016	.047	
28	175	7/36	7	36	.015	.016	.047	
26	264	66/44	66	44	.019	.016	.051	
26	304	19/38	19	38	.019	.016	.051	
26	278	7/34	7	34	.019	.016	.051	
24	420	3x35/44	105	44	.025	.016	.057	
24	404	42/40	42	40	.023	.016	.055	
24	475	19/36	19	36	.024	.016	.056	
24	448	7/32	7	32	.024	.016	.056	
22	634	66/40	66	40	.029	.016	.061	
22	754	19/34	19	34	.030	.016	.062	
22	700	7/30	7	30	.030	.016	.062	
20	1036	7x37/44	259	44	.040	.016	.072	
20	1050	42/36	42	36	.037	.016	.069	
20	1216	19/32	19	32	.038	.016	.070	
18	1652	7x59/44	413	44	.050	.016	.082	
18	1625	65/36	65	36	.047	.016	.079	
18	1900	19/30	19	30	.048	.016	.080	
16	2660	7x95/44	665	44	.064	.016	.096	
16	2691	7x40/40	280	40	.064	.016	.096	
16	2625	7x15/36	105	36	.063	.016	.095	
14	4200	7x3x50/44	1050	44	.082	.022	.126	
14	4238	7x3x21/40	441	40	.083	.022	.127	
14	4200	7x24/36	168	36	.080	.022	.124	
12	6664	7x7x34/44	1666	44	.108	.031	.170	
12	6458	7x96/40	672	40	.099	.031	.161	
12	6475	7x37/36	259	36	.099	.022	.143	
10	10325	7x59/36	413	36	.126	.022	.170	
10	10285	7x37/34	259	34	.125	.022	.169	
10	10500	7x15/30	105	30	.127	.022	.171	
9	13117	7x3x65/40	1365	40	.146	.022	.190	
9	13125	7x75/36	525	36	.142	.022	.186	
9	13300	7x19/30	133	30	.143	.022	.187	
8	16481	7x7x35/40	1715	40	.171	.033	.237	
8	16625	7x95/36	665	36	.159	.033	.225	
7	20825	7x119/36	833	36	.178	.033	.244	
6	26250	7x150/36	1050	36	.200	.033	.266	
5	33075	7x7x27/36	1323	36	.242	.033	.308	
4	45325	7x7x34/36	1666	36	.271	.033	.337	
3	52675	7x7x43/36	2107	36	.305	.033	.371	
2	66150	7x7x54/36	2646	36	.342	.033	.408	
1	72275	7x7x59/36	2891	36	.357	.033	.423	
1/0	105350	7x7x86/36	4214	36	.431	.044	.519	
2/0	132300	7x7x108/36	5292	36	.483	.055	.593	
3/0	169575	19x7x51/36	6783	36	.547	.055	.657	
4/0	212800	19X7X64/36	8512	36	.613	.055	.723	

All measurements are in inches unless otherwise stated.

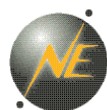

NEW ENGLAND WIRE TECHNOLOGIES  
Innovate. Create. Accelerate.



# UL Style 3123 Silicone Rubber Insulated Lead Wire

## 600 Volt, 150° C

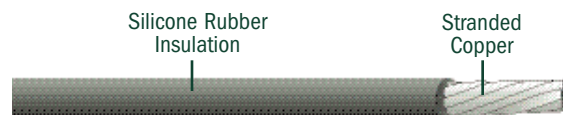

**DESCRIPTION:** UL, CSA Approved, VW-1 Rated. 30 - 16 AWG stranded tinned, nickel or silver plated copper conductor insulated with 33 mil wall of silicone rubber.

**USE:** Mercury switch leads and internal wiring of computers and electronic equipment.

		Construction	Number of Strands			Nominal Wall Thickness		
30	119	19/42	19	42	.012	.033	.078	
30	106	11/40	11	40	.012	.033	.078	
30	112	7/38	7	38	.012	.033	.078	
28	183	65/46	65	46	.015	.033	.081	
28	160	40/44	40	44	.015	.033	.081	
28	183	19/40	19	40	.015	.033	.081	
28	175	7/36	7	36	.015	.033	.081	
26	264	66/44	66	44	.019	.033	.085	
26	304	19/38	19	38	.019	.033	.085	
26	278	7/34	7	34	.019	.033	.085	
24	420	3x35/44	105	44	.025	.033	.091	
24	404	42/40	42	40	.023	.033	.089	
24	475	19/36	19	36	.024	.033	.090	
24	448	7/32	7	32	.024	.033	.090	
22	672	7x24/44	168	44	.032	.033	.098	
22	634	66/40	66	40	.029	.033	.095	
22	754	19/34	19	34	.030	.033	.096	
22	700	7/30	7	30	.030	.033	.096	
20	1036	7x37/44	259	44	.040	.033	.106	
20	1050	42/36	42	36	.037	.033	.103	
20	1216	19/32	19	32	.038	.033	.104	
18	1652	7x59/44	413	44	.050	.033	.116	
18	1575	7x24/40	168	40	.050	.033	.116	
18	1625	65/36	65	36	.047	.033	.113	
18	1900	19/30	19	30	.048	.033	.114	
16	2660	7x95/44	665	44	.064	.033	.130	
16	2691	7x40/40	280	40	.064	.033	.130	
16	2625	7x15/36	105	36	.063	.033	.129	

# UL Style 3132 Silicone Rubber Insulated Lead Wire

## 300 Volt, 150° C, Class 22



**DESCRIPTION:** 30 - 16 AWG solid or stranded tinned copper insulated with a minimum 15 mil wall of silicone rubber.

**USE:** Internal wiring of appliances where totally enclosed.

Equivalent AWG Size	CONDUCTOR				Nominal Conductor Diameter	Nominal Wall Thickness	Nominal OD
	Circular Mil Area	Construction	Number of Strands	AWG of Strands			
30	119	19/42	19	42	.012	.0165	.045
30	106	11/40	11	40	.012	.0165	.045
30	112	7/38	7	38	.012	.0165	.045
28	183	65/46	65	46	.015	.0165	.048
28	160	40/44	40	44	.015	.0165	.048
28	183	19/40	19	40	.015	.0165	.048
28	175	7/36	7	36	.015	.0165	.048
26	264	66/44	66	44	.019	.0165	.052
26	304	19/38	19	38	.019	.0165	.052
26	278	7/34	7	34	.019	.0165	.052
24	420	3x35/44	105	44	.025	.0165	.058
24	404	42/40	42	40	.023	.0165	.056
24	475	19/36	19	36	.024	.0165	.057
24	448	7/32	7	32	.024	.0165	.057
22	672	7x24/44	168	44	.032	.0165	.065
22	634	66/40	66	40	.029	.0165	.062
22	754	19/34	19	34	.030	.0165	.063
22	700	7/30	7	30	.030	.0165	.063
20	1036	7x37/44	259	44	.040	.0165	.073
20	1050	42/36	42	36	.037	.0165	.070
20	1216	19/32	19	32	.038	.0165	.071
18	1652	7x59/44	413	44	.050	.0165	.083
18	1575	7x24/40	168	40	.050	.0165	.083
18	1625	65/36	65	36	.047	.0165	.080
18	1900	19/30	19	30	.048	.0165	.081
16	2660	7x95/44	665	44	.064	.0165	.097
16	2691	7x40/40	280	40	.064	.0165	.097
16	2625	7x15/36	105	36	.063	.0165	.096

Our standard colors for primary and overall jackets include: white, black, red, green, yellow, blue, brown, orange, gray and violet. Custom color and/or exact color match available; please contact our design team for your specific requirement.

*All measurements are in inches unless otherwise stated.*

# HYflex™ Power Distribution Cables

## TECHNICAL INFORMATION

HYflex™ power distribution cables are specifically engineered to handle the high voltage and temperatures inherent with today's diesel hybrid vehicles. Independently tested to meet the requirements of SAE J 1654 and 1127, the HYflex™ line of cables is rated for use at 125°C and up to 600 volts.

HYflex™ incorporates a uniquely designed, high performance compound specifically formulated for use in heavy duty diesel hybrid vehicles and high strand count, flexible conductors to produce cables ideally suited for applications where flexibility, long life and performance is critical. These cables have also been tested to meet the stringent flame test requirements of VW-1 flame test per Underwriters Laboratories Standard for Safety UL1581.

HYflex™ cables are manufactured using high strand count tinned copper conductors. Standard sizes and constructions are listed below, however ultra flexible strandings and a variety of conductor materials are also available. Please contact our design team to discuss your specific requirement.

## PRODUCT ADVANTAGES

- \* Extra flexible high strand count, tinned copper conductors
- \* Meets SAE J 1654 & 1127 for 600 volt and 125° C diesel applications
- \* Improved flexibility over XLPO insulations
- \* Improved chemical resistance, temperature rating and cold weather performance vs. PVC
- \* Available in shielded and multiconductor configurations
- \* RoHS compliant
- \* Available in 10 standard colors

Part Number*	CONDUCTOR INFORMATION				INSULATION INFORMATION			WEIGHT
	Equivalent Size	Number of Strands	AWG of Strand	Nominal Outside Diameter**	Wall Thickness	Nominal Outside Diameter	Tolerance	LBS per 1000 FT
N48-30T-802	250 kCMA	2499	30	0.635"	0.088"	0.811"	+/- .020"	880.1
N48-30T-801	4/0 AWG	2121	30	0.585"	0.088"	0.761"	+/- .020"	754.0
N48-30T-752	3/0 AWG	1680	30	0.521"	0.088"	0.697"	+/- .020"	606.2
N48-30T-751	2/0 AWG	1344	30	0.466"	0.088"	0.642"	+/- .020"	492.9
N48-30T-753	1/0 AWG	1071	30	0.416"	0.088"	0.592"	+/- .020"	400.2
N48-30T-700	1 AWG	833	30	0.367"	0.066"	0.499"	+/- .016"	300.8
N48-30T-701	2 AWG	665	30	0.319"	0.066"	0.451"	+/- .016"	245.6
N48-30T-650	3 AWG	525	30	0.283"	0.066"	0.415"	+/- .016"	196.4
N48-30T-651	4 AWG	413	30	0.251"	0.066"	0.383"	+/- .016"	158.2
N48-30T-600	5 AWG	329	30	0.224"	0.066"	0.356"	+/- .016"	129.4
N48-30T-601	6 AWG	259	30	0.199"	0.066"	0.331"	+/- .016"	105.1
N48-30T-550 ^	7 AWG	210	30	0.179"	0.066"	0.311"	+/- .016"	98.9
N48-30T-551 ^	8 AWG	168	30	0.160"	0.066"	0.292"	+/- .016"	73.0

\*Multiconductor, shielded and unshielded cables also available. Please contact our design team for your specific application.

\*\*Conductor O.D. is determined when the cable is under tension during the extrusion process. Please request a sample of cable for evaluation prior to making decisions regarding connectors to be used with these cables.

^Manufactured and tested in accordance with SAE J 1127, however these sizes are not included in the specification.

**Reference documents:** ASTM B3-specification for soft or annealed copper wire; ASTM B 33-specification for tinned soft or annealed copper for electrical purposes; ASTM B 286-specification for copper conductors in hook-up wire for electronic equipment; SAE J 1127-Battery cable; SAE J 1654-High voltage primary cable and UL 1581 Standard for Safety of Electrical Wires, Cables and Flexible cords.

[www.newenglandwire.com](http://www.newenglandwire.com)

Tel: 603.838.6624

## TECHNICAL INFORMATION

**COLDflex Ground Cable™ product line is specifically designed for flexible, low-temperature ground cable applications. Tested for cold weather flexibility down to -40°C, COLDflex Ground Cables are UV resistant and have operating voltages up to 5kV.**

**Manufactured using highly stranded bare copper conductors, COLDflex Ground Cable™ standard conductor sizes and constructions are listed below. Ultra flexible stranded conductors are also available in a variety of conductor materials. Please contact our design team for more specific information or to discuss your specific requirements.**

**Our high performance compounds are specifically formulated for use where cold weather flexibility, UV resistance and high dielectric strength are required. Standard jacket colors include: white, black, red, green, yellow, blue, brown, orange, gray and violet. Custom colors and printing are available upon request.**

## PRODUCT ADVANTAGES

- \* Tested for cold weather flexibility down to -40° C
- \* UV resistant
- \* Operating voltages up to 5kV
- \* High dielectric strength
- \* Standard bare copper conductors; also available in variety of other conductor materials
- \* Standard sizes 250 kCMA - 4 AWG  
Other sizes available upon request
- \* Available in 10 standard colors
- \* Standard and custom surface printing available

Part Number	CONDUCTOR INFORMATION				INSULATION INFORMATION			WEIGHT
	Equivalent Size	Number of Strands	AWG of Strand	Nominal Outside Diameter*	Wall Thickness	Nominal Outside Diameter	Tolerance	LBS per 1000 FT
N48-30B-802	250 kCMA	2499	30	0.635"	0.085"	0.805"	+/- .020"	871.8
N48-30B-803	4/0 AWG	2121	30	0.585"	0.085"	0.755"	+/- .020"	746.6
N48-30B-755	3/0 AWG	1680	30	0.521"	0.085"	0.691"	+/- .020"	599.2
N48-30B-756	2/0 AWG	1344	30	0.466"	0.085"	0.636"	+/- .020"	486.5
N48-30B-757	1/0 AWG	1071	30	0.416"	0.085"	0.586"	+/- .020"	394.3
N48-30B-701	2 AWG	665	30	0.319"	0.065"	0.449"	+/- .016"	240.9
N48-30B-650	4 AWG	413	30	0.251"	0.065"	0.381"	+/- .016"	156.0

\*Conductor O.D. is determined when the cable is under tension during the extrusion process. Please request a sample of cable for evaluation prior to making decisions regarding connectors to be used with these cables.

**Reference documents:** ASTM B3-specification for soft or annealed copper wire; ASTM B 33-specification for tinned soft or annealed copper for electrical purposes; ASTM B 286-specification for copper conductors in hook-up wire for electronic equipment; CSA C22.2 No. 3-01 Test methods for electrical wires and cables; and UL 1581 Standard for Safety for Electrical Wires, Cables.

*All measurements are in inches unless otherwise stated.*



# PVC Insulated Ground Strap 300 Volt, 105° C



**DESCRIPTION:** Braided tin-plated copper conductor insulated with extruded PVC which is resistant to water, oil, acids and solvents and is self-extinguishing.

**USE:** Insulated bonds, grounds, leads, flexible connectors.

Typically constructed with tinned or bare copper wire, material may also be supplied to UL Style 1680; please contact our design team to assist you with a product for your specific application.

Equivalent AWG Size	Circular Mil Area	Wire AWG	Number of Wires	Braid Construction	BRAID DIMENSION		INSULATION DIMENSION		
					Nominal Width	Nominal Thickness	Nominal Wall	Nominal Width	Nominal Thickness
18	1800	36	72	24-3-36	.109	.025	.015	.139	.055
16	2400	36	96	24-4-36	.156	.025	.015	.186	.055
15	3000	36	120	24-5-36	.188	.025	.020	.228	.065
14	4200	36	168	24-7-36	.219	.031	.020	.259	.071
12	6000	36	240	24-10-36	.250	.040	.020	.290	.080
12	7200	36	288	48-6-36	.375	.031	.020	.415	.071
10	9600	30	96	24-4-30	.313	.050	.020	.353	.090
10	9600	36	384	24-16-36	.375	.063	.020	.415	.103
10	9600	36	384	48-8-36	.500	.031	.020	.540	.071
9	12000	30	120	24-5-30	.375	.050	.020	.415	.090
9	13200	36	528	48-11-36	.625	.040	.020	.665	.080
8	16800	30	168	24-7-30	.438	.063	.030	.498	.123
8	18000	36	720	48-15-36	.625	.040	.030	.685	.100
7	21600	36	864	48-18-36	.625	.050	.030	.685	.110
6	24000	30	240	24-10-30	.500	.094	.030	.560	.154
6	26400	36	1056	48-22-36	.875	.050	.030	.935	.110
5	36000	30	360	24-15-30	.625	.094	.030	.685	.154
4	43200	30	432	24-18-30	.719	.094	.030	.779	.154
3	48000	30	480	24-20-30	.750	.125	.030	.810	.185
2	64800	30	648	24-27-30	.938	.125	.030	.998	.185
1	76800	30	768	24-32-30	1.000	.125	.040	1.080	.205
1/0	105600	30	1056	24-44-30	1.250	.125	.040	1.330	.205

\* Material is manufactured to width specification; thickness dimensions are given as reference only and may vary slightly due manufacturing process inherent with braiding. Please contact your design team if you have specific thickness dimensions.

All measurements are in inches unless otherwise stated.

[www.newenglandwire.com](http://www.newenglandwire.com)  
Tel: 603.838.6624



The term “Litz,” derived from the German word “Litzendraht” describes a conductor consisting of insulated strands twisted or braided together. This design equalizes the flux linkages and the individual strands causing the current to spread uniformly throughout the conductor. The resistance ratio (A.C. to D.C.) then tends to approach unity, which is desirable in all high-Q circuit applications.

In 1898, New England Wire became the first company in the United States to manufacture Litz wire on a commercial basis. Since then we have designed and manufactured thousands of constructions for use in high frequency inductors and transformers, inverters, communication equipment, ultrasonic equipment, sonar equipment, television equipment, radio equipment and induction heating equipment. We have also provided cabling, insulating and other services to the superconductor industry since its inception in the early 1960s. And our products are integrated into major accelerator projects, ore separator magnets, NMR magnets, and superconducting magnetic energy storage magnets.

### **WINDING WIRES**

New England Wire Technologies also manufactures specialty winding wires that reduce the size of your designs and save you time and money.

NEWind® Specialty Winding Wire solves the problem of insulating between winding turns by coating the conductors with thin layers of fluoropolymer insulation.

## LITZ & WINDING WIRES

New England Wire Technologies is a pioneer and leading designer and manufacturer of Litz wire and specialty winding wire. Litz wire conductors are beneficial for reducing A.C. losses in high frequency windings. New England Wire offers many Litz wire constructions with multiple layers of insulation to meet voltage withstand requirements of UL and IEC.

Our NE-F1 Class F (155° C) Electrical Insulation Systems featuring NEWind® Specialty Winding Wires meets UL 1446 Electrical Insulation System. These high performance products eliminate the need for long term component testing and allow the development of unique solutions to your most complex design challenges, making them ideal for transformer, motor and coil applications.

Litz Wire Types & Constructions . . . . .	129	Fiber & Tape Insulations . . . . .	147
Litz Wire Info Page . . . . .	130	NEWind® Specialty Winding Wire . . . . .	148
Round Litz . . . . .	132	NEWind® Solid/PFA . . . . .	149
Rectangular Braided Litz . . . . .	137	NEWind® Solid/FEP . . . . .	150
Rectangular Compacted Litz . . . . .	138	NEWind® Solid/ETFE . . . . .	151
Single Film Coated-Round . . . . .	144	NE-F1® Classs F Electrical Insulation System . . . . .	152
Heavy Film Coated-Round . . . . .	145		
Film Insulations . . . . .	146		



# LITZ WIRE TYPES & CONSTRUCTION

## Round Type 1

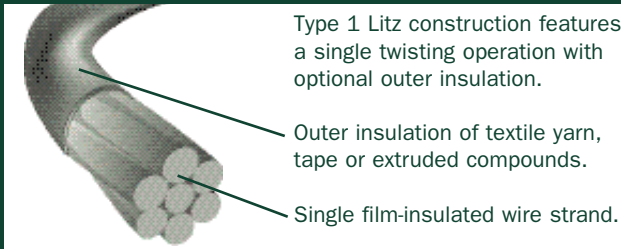

Type 1 Litz construction features a single twisting operation with optional outer insulation.

Outer insulation of textile yarn, tape or extruded compounds.

Single film-insulated wire strand.

## Round Type 5

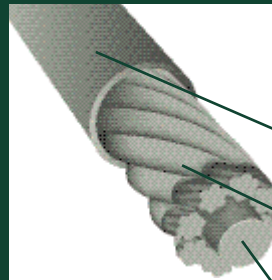

Type 5 Litz construction features insulated bundles of Type 2 Litz wire twisted around a fiber core.

Optional outer insulation of textile yarn, tape or extruded compounds.

Individually insulated bundles of Type 2 Litz wire.

Fiber core.

## Round Type 2

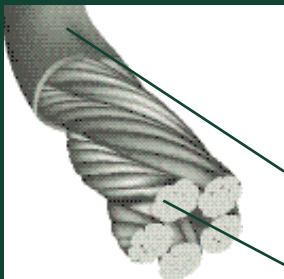

Type 2 Litz construction features bundles of twisted wire twisted together with optional outer insulation.

Outer insulation of textile yarn, tape or extruded compounds.

Bundles of Type 1 Litz wire.

## Round Type 6

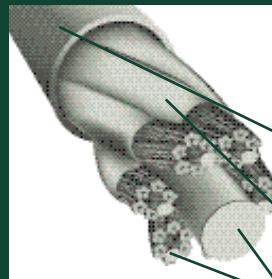

Type 6 Litz construction features insulated bundles of Type 4 Litz wire twisted around a fiber core.

Optional outer insulation of textile yarn, tape or extruded compounds.

Bundles of Type 4 Litz wire insulated with nylon serving.

Fiber cores.

## Round Type 3

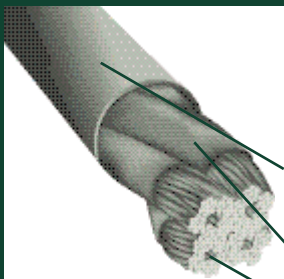

Type 3 Litz construction features insulated bundles of twisted wire twisted together with optional outer insulation.

Outer insulation of textile yarn, tape or extruded compounds.

Individually insulated bundles.

Bundles of Type 2 Litz wire.

## Rectangular Type 7

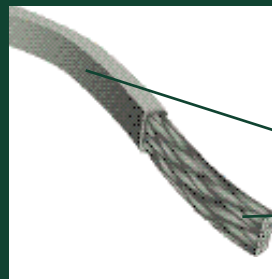

Type 7 Litz construction features insulated wire braided and formed into rectangular profile.

Optional outer insulation of textile yarn, tape or extruded compounds.

Braided film-insulated wire.

## Round Type 4

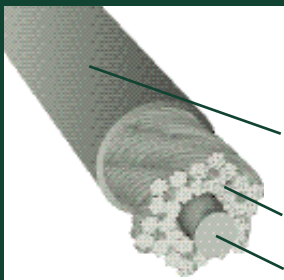

Type 4 Litz construction features bundles of twisted wire twisted together around a central fiber core.

Outer insulation of textile yarn, tape or extruded compounds.

Bundles of Type 2 Litz wire.

Fiber core.

## Rectangular Type 8

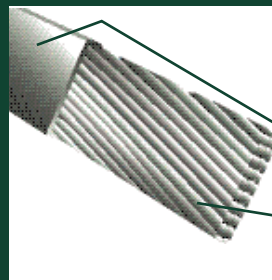

Type 8 Litz construction features insulated strands twisted and compressed into rectangular profile.

Optional outer insulation of textile yarn, tape or extruded compounds.

Compacted film-insulated wires or compacted groups.

[www.newenglandwire.com](http://www.newenglandwire.com)

Tel: 603.838.6624

# Litz Wire

For optimum performance, the Litz constructions covered in this section are made with individually insulated strands. Common magnet wire film insulations such as: polyvinylformal, polyurethane, polyurethane/nylon; solderable polyester, solderable polyester/nylon, polyester/polyamide-imide, and polyimide are normally used. The outer insulation and the insulation on the component conductors, in some styles, may be servings or braids of nylon, cotton, Nomex<sup>1</sup>, fiberglass or ceramic. Polyester, heat sealed polyester, polyimide and PTFE tape wraps along with extrusions of most thermoplastics are also available as outer insulation if the applications dictate special requirements for voltage breakdown or environmental protection.

## Litz Design

Typically, the design engineer requiring the use of Litz knows the operating frequency and RMS current required for the application. Since the primary benefit of a Litz conductor is the reduction of A.C. losses, the first consideration in any Litz design is the operating frequency. The operating frequency not only influences the actual Litz construction, but is also used to determine the individual wire gauge.

Ratios of alternating-current resistance to direct-current resistance for an isolated solid round wire (H) in terms of a value (X) are shown in Table 1.

**Table 1**

<b>X</b>	0	0.5	0.6	0.7	0.8	0.9	1.0
<b>H</b>	1.0000	1.0003	1.0007	1.0012	1.0021	1.0034	1.005

The value of X for copper wire is determined by Formula 1.

**FORMULA 1**

$$X = 0.271 D_M \sqrt{F_{MHz}}$$

Where:  $D_M$  = Wire diameter in mills  
 $F_{MHz}$  = Frequency in Megahertz

From Table 1 and other empirical data the following table of recommended wire gauges vs. frequency for most Litz constructions has been prepared.

**Table 2**

FREQUENCY	RECM'D WIRE GAUGE	NOM. DIA. OVER COPPER	DC RES. OHMS/M' (MAX)	SINGLE STRAND $R_{ac}/R_{dc}$ "H"
60 HZ to 1 KHZ	28 AWG	.0126	66.37	1.0000
1 KHZ to 10 KHZ	30 AWG	.0100	105.82	1.0000
10 KHZ to 20 KHZ	33 AWG	.0071	211.70	1.0000
20 KHZ to 50 KHZ	36 AWG	.0050	431.90	1.0000
50 KHZ to 100 KHZ	38 AWG	.0040	681.90	1.0000
100 KHZ to 200 KHZ	40 AWG	.0031	1152.3	1.0000
200 KHZ to 350 KHZ	42 AWG	.0025	1801.0	1.0000
350KHZ to 850 KHZ	44 AWG	.0020	2873.0	1.0003
850 KHZ to 1.4 MHZ	46 AWG	.0016	4544.0	1.0003
1.4MHZ to 2.8 MHZ	48 AWG	.0012	7285.0	1.0003

After the individual wire gauge has been determined and assuming that the Litz construction has been designed such that each strand tends to occupy all possible positions in the cable to approximately the same extent, the ratio of A.C. to D.C. resistance of an isolated Litz conductor can be determined from the following formula.

**FORMULA 2<sup>2</sup>**

$$\frac{\text{Resistance to Alternating Current}}{\text{Resistance to Direct Current}} = H + K \left( \frac{N D_i}{D_o} \right)^2 G$$

<sup>1</sup> DuPont Registered Trademark

<sup>2</sup> See Radio Engineers Handbook - Terman, pp. 30-83.



Where: H = Resistance ratio of individual strands when isolated (taken from Table 1 or 2)

$$G = \text{Eddy-current basis factor} = \left( \frac{D_i \sqrt{F}}{10.44} \right)^4$$

F = Operating frequency in HZ

N = Number of strands in the cable

D<sub>i</sub> = Diameter of the individual strands over the copper in inches

D<sub>o</sub> = Diameter of the finished cable over the strands in inches

K = Constant depending on N, given in the following table

N	3	9	27	Infinity
K	1.55	1.84	1.92	2

The D.C. resistance of a Litz conductor is related to the following parameters:

1. AWG of the individual strands.
2. Number of strands in the cable.
3. Factors relating to the increased length of the individual strands per unit length of cable (take-up). For normal Litz constructions a 1.5% increase in D.C. resistance for every bunching operation and a 2.5% increase in D.C. resistance for every cabling operation are approximately correct.

The formula derived from these parameters for the D.C. resistance of any Litz construction is:

FORMULA 3

$$R_{DC} = \frac{R_s (1.02)^{N_b} (1.03)^{N_c}}{N_s}$$

Where: R<sub>DC</sub> = Resistance in Ohms/1000 ft.

R<sub>s</sub> = Maximum D.C. resistance of the individual strands (taken from Table 2)

N<sub>b</sub> = Number of bunching operations

N<sub>c</sub> = Number of cabling operations

N<sub>s</sub> = Number of individual strands

Following is an example of the calculations required to evaluate a Type 2 Litz construction consisting of 450 strands of 40 AWG single-film polyurethane-coated wire operating at 100 KHZ. This construction, designed with two bunching operations and one cabling operation, would be written 5x3/30/40 (NEW uses "x" to indicate a cabling operation and "/" to indicate a bunching operation.)

**1. Calculate the D.C. resistance of the Litz construction using formula 3.**

$$R_{DC} = \frac{1152.3 \times (1.015)^2 \times (1.025)^1}{450} = 2.70 \text{ ohms/1000'}$$

**2. Calculate the A.C. to D.C. resistance ratio using formula 2.**

$$\frac{R_{AC}}{R_{DC}} = 1.0000 + 2 \left( \frac{450 \times 0.0031}{0.094} \right)^2 (7.8 \times 10^{-6}) = 1.0344$$

**3. The A.C. resistance is, therefore, 1.0344 x 2.70 or 2.79 ohms/1000 ft.**

The value of Litz can easily be seen if the above example is compared with a solid round wire with equivalent cross sectional area, 65.8 mils in diameter. Using the same operating parameters, the D.C. resistance is 2.395 ohms/1000 ft. However, the A.C./D.C. resistance ratio increases to approximately 21.4 making the A.C. resistance 51.3 ohms/1000 ft.

The following tables list examples of Litz constructions which can be manufactured by New England Wire Technologies. These are categorized by operating frequency and by equivalent AWG size. Round, braided and rectangular Litz conductors are shown separately to provide the greatest possible selection for any design application.

# Round Litz

Litz constructions Types 1 through 6 are all designed to be round and vary from a simple bunch of conductors (Type 1) to complex designs utilizing multiple cores and several manufacturing operations (Type 6).

The smaller constructions of Litz Types 1 and 2 are typically used in High Q circuitry, such as toroidal coils and transformers. The larger Type 2 and 3 Litz designs have greater current carrying capacities necessary for high frequency power supply, inverter and grounding applications. Type 4, 5 and 6 Litz constructions all utilize at least one inert core and are used primarily in tuning circuitry for high power radio transmitters.

Equivalent AWG	Circular Mil Area	Number of Wires	AWG of Wire	Film Coating <sup>1</sup>	Construction Type	Outer Insulation <sup>2</sup>	Nominal OD	Nominal LBS./1000 FT.	Direct Current Resistance OHM/1000 FT <sup>^</sup>	Construction
<b>RECOMMENDED OPERATING FREQUENCY - 60 HZ TO 1 KHZ</b>										
24	476	3	28	S	1	-	.027	1.49	22.570	3/28
22	794	5	28	S	1	-	.035	2.49	13.540	5/28
20	1112	7	28	S	1	-	.042	3.49	9.670	7/28
18	1588	10	28	S	1	-	.050	4.99	6.770	10/28
16	2700	17	28	S	1	SN	.065	8.68	3.980	17/28
14	4129	26	28	S	1	SN	.080	13.23	2.600	26/28
12	6670	42	28	S	1	SN	.102	21.28	1.610	42/28
10	10480	66	28	S	2	SN	.140	34.02	1.060	3X22/28
8	16674	105	28	S	2	SN	.177	54.01	.660	3X35/28
6	26202	165	28	S	2	SN	.222	86.59	.420	5X33/28
4	42240	266	28	S	2	DN	.285	141.87	.260	7X38/28
2	66696	420	28	S	2	DN	.431	227.39	.170	5X3X28/28
1/0	105602	665	28	S	2	SNB	.537	366.00	.110	7X5X19/28
2/0	133392	840	28	S	5	SNB	.657	480.00	.084	6(5X28/28)
3/0	171504	1080	28	S	5	SNB	.787	634.00	.065	9(5X24/28)
4/0	217238	1368	28	S	5	SNB	.941	828.00	.051	12(3X38/28)
<b>RECOMMENDED OPERATING FREQUENCY - 1 HZ TO 10 KHZ</b>										
26	300	3	30	S	1	-	.022	.95	35.980	3/30
24	500	5	30	S	1	-	.028	1.58	21.590	5/30
22	700	7	30	S	1	-	.033	2.21	15.420	7/30
20	1100	11	30	S	1	-	.045	3.47	9.810	11/30
18	1700	17	30	S	1	SN	.055	5.52	6.350	17/30
16	2600	26	30	S	1	SN	.064	8.38	4.150	26/30
14	4200	42	30	S	1	SN	.082	13.48	2.570	42/30
12	6500	65	30	S	2	SN	.112	21.21	1.710	5X13/30
10	11000	110	30	S	2	SN	.145	35.75	1.010	5X22/30
8	16800	168	30	H	2	-	.191	55.03	.660	7X24/30
7	25900	259	30	H	2	-	.237	84.83	.430	7X37/30
6	26600	266	30	H	2	-	.240	87.13	.420	7X38/30
4	41300	413	30	H	2	-	.300	138.27	.270	7X59/30
3	52500	525	30	H	2	-	.338	171.96	.210	7X75/30
2	66500	665	30	H	2	-	.380	217.81	.170	7X95/30
2	80500	805	30	H	2	DN	.421	272.95	.140	7X115/30
1/0	125000	1250	30	S	2	SNB	.631	435.00	.090	5X5X50/30
2/0	135000	1350	30	S	5	SNB	.667	486.00	.083	6(5X45/30)
3/0	195000	1950	30	S	5	SNB	.794	697.00	.057	6(5X5X13/30)
4/0	252000	2520	30	S	5	SNB	.981	916.00	.045	6(5X3X28/30)

- 1 S = single-film coating thickness  
H = heavy-film coating thickness
- 2 SN = single nylon serving  
DN = double nylon serving  
SNB = single nylon braid  
PVC = extruded polyvinylchloride

<sup>^</sup> Not for specification purposes.

All measurements are in inches unless otherwise stated.



# Round Litz, *continued*

Equivalent AWG	Circular Mil Area	Number of Wires	AWG of Wire	Film Coating <sup>1</sup>	Construction Type	Outer Insulation <sup>2</sup>	Nominal OD	Nominal LBS/1000 FT	Direct Current Resistance OHMS/1000 FT <sup>^</sup>	Construction
<b>RECOMMENDED OPERATING FREQUENCY - 10 KHZ TO 20 KHZ</b>										
26	303	6	33	S	1	SN	.025	1.00	35.990	6/33
24	403	8	33	S	1	-	.025	1.27	26.990	8/33
22	655	13	33	S	1	SN	.035	2.13	16.610	13/33
20	1059	21	33	S	1	SN	.044	3.41	10.280	21/33
18	1613	32	33	S	1	SN	.054	5.24	6.750	32/33
16	2672	53	33	S	1	SN	.066	8.59	4.070	53/33
14	5041	100	33	S	2	SN	.099	16.44	2.220	5X20/33
12	7562	150	33	S	2	SN	.121	24.60	1.480	5X30/33
10	10586	210	33	S	2	SN	.143	34.36	1.060	3X70/33
8	16585	329	33	S	2	DN	.175	55.20	.680	7X47/33
6	26465	525	33	S	2	DN	.237	92.03	.440	5X3X35/33
4	42849	850	33	S	2	DN	.302	147.14	.270	5X5X34/33
2	66541	1320	33	S	5	SNB	.484	244.00	.171	6(5X44/33)
1	90738	1800	33	S	5	SNB	.558	334.00	.127	6(3/5/20/33)
1/0	105861	2100	33	S	5	SNB	.600	383.00	.107	6(5/70/33)
2/0	136107	2700	33	S	5	SNB	.675	496.00	.084	6(5X3/30/33)
3/0	169377	3360	33	S	5	SNB	.850	651.00	.067	12(5X56/33)
4/0	211772	4200	33	S	5	SNB	.987	841.00	.054	14(5X3/20/33)
-	299435	5940	33	S	6	PVC	1.290	1255.00	.038	6(6(5/33/33))
-	512972	10176	33	S	6	PVC	1.800	2283.00	.022	8(6(4X53/33))
-	725904	14400	33	S	6	PVC	2.420	3550.00	.016	15(6(5X32/33))
-	917462	18200	33	S	6	PVC	3.120	5088.00	.012	20(13(70/33))
-	1572792	31200	33	S	6	PVC	3.990	8684.00	.007	20(6(5/52/33))

<b>RECOMMENDED OPERATING FREQUENCY - 20 KHZ TO 50 KHZ</b>										
30	100	4	36	S	1	-	.013	.318	110.100	4/36
28	175	7	36	S	1	-	.017	.557	62.900	7/36
26	250	10	36	S	1	SN	.023	.839	44.050	10/36
24	400	16	36	S	1	SN	.029	1.340	27.530	16/36
22	675	27	36	S	1	SN	.037	2.220	16.320	27/36
20	1025	41	36	S	1	SN	.044	3.350	10.740	41/36
18	1625	65	36	S	2	SN	.059	5.440	6.980	5X13/36
16	2625	105	36	S	2	SN	.074	8.740	4.320	3X35/36
14	4125	165	36	S	2	SN	.092	13.660	2.750	5X33/36
12	6625	265	36	S	2	SN	.116	21.830	1.710	5X53/36
10	10500	420	36	S	2	DN	.158	35.630	1.110	5X3X28/36
8	16500	660	36	S	2	DN	.197	59.010	.710	5X3X44/36
6	26250	1050	36	S	2	DN	.247	92.450	.450	5X5X42/36
4	45000	1800	36	S	2	DN	.322	156.420	.260	5X5X72/36
2	66500	2660	36	S	2	DN	.373	228.670	.180	7X5X76/36
1	84000	3360	36	S	5	SNB	.548	318.000	.140	6(5X4X28/36)
1/0	108000	4320	36	S	5	SNB	.655	420.000	.109	9(5X3X32/36)
2/0	135000	5400	36	S	5	SNB	.728	522.000	.087	9(5X3X40/36)
3/0	171000	6840	36	S	5	SNB	.870	682.000	.069	12(5X3X38/36)
4/0	211500	8460	36	S	5	SNB	.962	840.000	.055	12(5X3X47/36)

- 1 S = single-film coating thickness  
H = heavy-film coating thickness
- 2 SN = single nylon serving  
DN = double nylon serving  
SNB = single nylon braid  
PVC = extruded polyvinylchloride

<sup>^</sup> *Not for specification purposes.*

*All measurements are in inches unless otherwise stated.*

**www.newenglandwire.com**  
**Tel: 603.838.6624**

# Round Litz, *continued*

Equivalent AWG	Circular Mil Area	Number of Wires	AWG of Wire	Film Coating <sup>1</sup>	Construction Type	Outer Insulation <sup>2</sup>	Nominal OD	Nominal LBS/1000 FT	Direct Current Resistance OHMS/1000 FT <sup>^</sup>	Construction
<b>RECOMMENDED OPERATING FREQUENCY - 50 KHZ TO 100 KHZ</b>										
30	112	7	38	S	1	SN	.017	.380	99.360	7/38
28	160	10	38	S	1	SN	.019	.542	69.550	10/38
26	256	16	38	S	1	SN	.024	.850	43.470	16/38
24	400	25	38	S	1	SN	.029	1.320	27.820	25/38
22	640	40	38	S	1	SN	.036	2.060	17.390	40/38
20	1056	66	38	S	1	SN	.045	3.380	10.750	3/22/38
18	1600	100	38	S	2	SN	.059	5.250	7.160	5X20/38
16	2592	162	38	S	2	SN	.069	8.270	4.380	3/54/38
14	4160	260	38	S	2	SN	.093	13.470	2.760	5X52/38
12	6720	420	38	S	2	SN	.117	21.690	1.740	5X3/28/38
10	10560	660	38	S	2	DN	.149	33.980	1.110	5X3/44/38
8	16800	1050	38	S	2	DN	.200	58.940	.700	5X5X42/38
6	26400	1650	38	S	2	DN	.249	91.200	.450	5X5X66/38
4	42000	2625	38	S	2	DN	.320	143.450	.290	5X5X3/35/38
2	66240	4140	38	S	5	SNB	.494	247.000	.180	6(5X3/46/38)
1	84000	5250	38	S	5	SNB	.551	311.000	.141	6(5X5X35/38)
1/0	105600	6600	38	S	5	SNB	.613	389.000	.112	6(5X5X44/38)
2/0	136000	8500	38	S	5	SNB	.749	522.000	.087	10(5X5X34/38)
3/0	168000	10500	38	S	5	SNB	.828	642.000	.070	10(5X5X42/38)
4/0	211200	13200	38	S	5	SNB	.966	824.000	.056	12(5X5X44/38)

<b>RECOMMENDED OPERATING FREQUENCY - 100 KHZ TO 200 KHZ</b>										
34	38.4	4	40	S	1	-	.008	.127	293.840	4/40
32	67.3	7	40	S	1	-	.011	.221	167.910	7/40
30	106.0	11	40	S	1	SN	.016	.379	106.850	11/40
28	163.0	17	40	S	1	SN	.020	.580	69.140	17/40
26	260.0	27	40	S	1	SN	.024	.897	43.530	27/40
24	404.0	42	40	S	1	SN	.029	1.397	27.980	42/40
22	634.0	66	40	S	2	SN	.038	2.197	18.340	3X22/40
20	1036.0	108	40	S	2	SN	.045	3.492	11.100	3/36/40
18	1634.0	170	40	S	2	SN	.056	5.537	7.050	5/34/40
16	2595.0	270	40	S	2	SN	.069	8.809	4.530	3/3/30/40
14	4180.0	435	40	S	2	SN	.093	14.264	2.840	5X3/29/40
12	6727.0	700	40	S	2	SN	.126	23.371	1.780	5X5X28/40
10	10571.0	1100	40	S	2	SN	.157	36.608	1.130	5X5X44/40
8	17298.0	1800	40	S	5	DN	.236	66.600	.700	6(5X3/20/40)
6	26812.0	2790	40	S	5	DN	.293	103.000	.451	6(5X3/31/40)
4	42813.0	4455	40	S	5	SNB	.431	176.000	.282	9(5X3/33/40)
2	69192.0	7200	40	S	5	SNB	.572	290.000	.174	12(5X3/40/40)
1/0	105710.0	11000	40	S	5	SNB	.668	428.000	.114	10(5X5X44/40)

- 1 S = single-film coating thickness  
H = heavy-film coating thickness
- 2 SN = single nylon serving  
DN = double nylon serving  
SNB = single nylon braid  
PVC = extruded polyvinylchloride

<sup>^</sup> Not for specification purposes.

All measurements are in inches unless otherwise stated.



# Round Litz, *continued*

Equivalent AWG	Circular Mil Area	Number of Wires	AWG of Wire	Film Coating <sup>1</sup>	Construction Type	Outer Insulation <sup>2</sup>	Nominal OD	Nominal LBS/1000 FT.	Direct Current Resistance OHMS/1000 FT <sup>^</sup>	Construction
<b>RECOMMENDED OPERATING FREQUENCY - 200 KHZ TO 350 KHZ</b>										
36	25	4	42	S	1	-	.006	.079	459.260	4/42
34	44	7	42	S	1	SN	.012	.169	262.430	7/42
32	63	10	42	S	1	SN	.013	.228	183.700	10/42
30	100	16	42	S	1	SN	.016	.346	114.810	16/42
28	163	26	42	S	1	SN	.019	.542	70.650	26/42
26	250	40	42	S	1	SN	.023	.829	45.930	40/42
24	413	66	42	S	2	SN	.029	1.370	28.390	3/22/42
22	656	105	42	S	2	SN	.036	2.130	17.850	5/21/42
20	1031	165	42	S	2	SN	.045	3.330	11.360	5/33/42
18	1688	270	42	S	2	SN	.060	5.580	7.150	5X3/18/42
16	2625	420	42	S	2	SN	.074	8.630	4.600	5X3/28/42
14	4125	660	42	S	2	SN	.092	13.490	2.920	5X3/44/42
12	6563	1050	42	S	2	DN	.127	21.820	1.860	5X5X42/42
10	10687	1710	42	S	5	DN	.185	40.300	1.150	6(5X3/19/42)
8	16875	2700	42	S	5	DN	.231	63.000	.729	6(5X3/30/42)
6	26250	4200	42	S	5	DN	.287	97.100	.468	6(5X5/28/42)
4	42188	6750	42	S	5	SNB	.434	169.000	.291	10(5X3/45/42)
2	67500	10800	42	S	5	SNB	.561	272.000	.182	12(5X5/36/42)

<b>RECOMMENDED OPERATING FREQUENCY - 350 KHZ TO 850 KHZ</b>										
38	16	4	44	S	1	-	.005	.050	732.620	4/44
36	28	7	44	S	1	SN	.010	.118	418.640	7/44
34	40	10	44	S	1	SN	.011	.156	293.050	10/44
32	64	16	44	S	1	SN	.013	.230	183.150	16/44
30	100	25	44	S	1	SN	.016	.342	117.220	25/44
28	160	40	44	S	1	SN	.019	.529	73.260	40/44
26	264	66	44	S	2	SN	.024	.874	45.290	3/22/44
24	420	105	44	S	2	SN	.029	1.380	28.470	3/35/44
22	640	160	44	S	2	SN	.035	2.060	18.680	5/32/44
20	1020	255	44	S	2	SN	.044	3.250	11.720	5/51/44
18	1620	405	44	S	2	SN	.058	5.310	7.600	5X3/27/44
16	2600	650	44	S	2	SN	.072	8.470	4.740	5X5/26/44
14	4200	1050	44	S	2	SN	.094	13.870	2.960	5X5X42/44
12	6600	1650	44	S	2	DN	.120	22.010	1.920	5X5X3/22/44
10	10500	2625	44	S	2	DN	.149	34.810	1.210	5X5X3/35/44
8	16800	4200	44	S	5	DN	.226	62.000	.747	6(5X5/28/44)

1 S = single-film coating thickness  
H = heavy-film coating thickness

2 SN = single nylon serving  
DN = double nylon serving  
SNB = single nylon braid  
PVC = extruded polyvinylchloride

<sup>^</sup> Not for specification purposes.

All measurements are in inches unless otherwise stated.

# Round Litz, *continued*

Equivalent AWG	Circular Mil Area	Number of Wires	AWG of Wire	Film Coating <sup>1</sup>	Construction Type	Outer Insulation <sup>2</sup>	Nominal OD	Nominal LBS./1000 FT	Direct Current Resistance OHMS/1000 FT <sup>^</sup>	Construction
<b>RECOMMENDED OPERATING FREQUENCY - 850 KHZ TO 1.4 MHZ</b>										
38	17.3	7	46	S	1	-	.005	.054	662.13	7/46
36	24.7	10	46	S	1	SN	.009	.108	463.49	10/46
34	39.5	16	46	S	1	SN	.011	.155	289.68	16/46
32	64.2	26	46	S	1	SN	.013	.232	178.26	26/46
30	101.0	41	46	S	1	SN	.016	.349	113.05	41/46
28	163.0	66	46	S	2	SN	.019	.554	71.63	3/22/46
26	259.0	105	46	S	2	SN	.023	.865	45.02	3/35/46
24	408.0	165	46	S	2	SN	.029	1.350	28.65	5/33/46
22	667.0	270	46	S	2	SN	.038	2.200	18.03	3X3/30/46
20	1038.0	420	46	S	2	SN	.047	3.400	11.59	5X3/28/46
18	1630.0	660	46	S	2	SN	.058	5.380	7.38	5X3/44/46
16	2593.0	1050	46	S	2	SN	.072	8.480	4.64	5X5/42/46
14	4261.0	1725	46	S	2	DN	.094	14.440	2.91	5X5X3/23/46
12	6669.0	2700	46	S	2	DN	.120	22.400	1.86	5X5X3/36/46
10	10745.0	4350	46	S	5	DN	.191	40.500	1.14	6(5X5/29/46)

<b>RECOMMENDED OPERATING FREQUENCY - 1.4 MHZ TO 2.8 MHZ</b>										
42	7.7	5	48	S	1	-	.004	.246	1486.14	5/48
40	10.8	7	48	S	1	SN	.007	.034	1061.53	7/48
38	18.5	12	48	S	1	SN	.009	.090	619.23	12/48
36	27.7	18	48	S	1	SN	.010	.120	412.82	18/48
34	40.0	26	48	S	1	SN	.011	.159	285.80	26/48
32	69.3	45	48	S	1	SN	.014	.252	165.13	45/48
30	102.0	66	48	S	2	SN	.016	.356	114.84	3/22/48
28	162.0	105	48	S	2	SN	.020	.560	71.18	5/21/48
26	277.0	180	48	S	2	SN	.026	.955	42.52	5X36/48
24	462.0	300	48	S	2	SN	.031	1.560	25.77	5/3/20/48
22	647.0	420	48	S	2	SN	.036	2.160	18.41	5/3/28/48
20	1040.0	675	48	S	2	SN	.048	3.470	11.57	5X3/45/48
18	1694.0	1100	48	S	2	SN	.060	5.680	7.10	5X5/44/48
16	2657.0	1725	48	S	2	SN	.074	9.350	4.62	5X5/3/23/48
14	4158.0	2700	48	S	2	SN	.093	14.600	2.95	5X5/3/36/48
12	6930.0	4500	48	S	5	DN	.159	26.900	1.77	6(5X5/30/48)

- 1 S = single-film coating thickness  
H = heavy-film coating thickness
- 2 SN = single nylon serving  
DN = double nylon serving  
SNB = single nylon braid  
PVC = extruded polyvinylchloride

<sup>^</sup> **Not for specification purposes.**

*All measurements are in inches unless otherwise stated.*





# Rectangular Braided Litz

The Type 7 braided Litz constructions shown below are used primarily in high frequency grounding applications, or where special inductor designs require high aspect ratio conductors. We have listed only the most popular constructions and frequency ranges. Specific sizes utilizing almost any wire gauge are available to meet customer specification.

Equivalent AWG	Circular Mil Area	Number of Wires	AWG of Wire	Film Coating <sup>1</sup>	Nominal Width	Nominal Thickness	Nominal LBS/1000 FT	Construction
<b>RECOMMENDED OPERATING FREQUENCY - 1 KHZ TO 15 KHZ</b>								
10	9600	96	30	H	.363	.073	33	24-4-30
9	12000	120	30	H	.435	.073	41	24-5-30
8	16800	168	30	H	.508	.073	58	24-7-30
6	24000	240	30	H	.580	.109	83	24-10-30
5	36000	360	30	H	.725	.109	124	24-15-30
5	33600	336	30	H	1.600	.073	121	48-7-30
4	48000	480	30	H	.870	.145	173	24-20-30
3	64800	648	30	H	1.090	.145	227	24-27-30
2	76800	768	30	H	1.160	.145	279	24-32-30
1/0	105600	1056	30	H	1.450	.145	373	24-44-30
2/0	153600	1536	30	H	2.320	.181	526	48-32-30
3/0	168000	1680	30	H	2.610	.181	569	48-35-30
4/0	249600	2496	30	H	2.900	.181	824	48-52-30
<b>RECOMMENDED OPERATING FREQUENCY - 15 KHZ TO 50 KHZ</b>								
22	800	32	36	H	.075	.038	2.79	16-2-36
18	1600	64	36	H	.113	.038	5.41	16-4-36
16	2400	96	36	H	.188	.038	8.50	24-4-36
14	4200	168	36	H	.263	.038	15.00	24-7-36
12	7200	288	36	H	.450	.038	26.00	48-6-36
10	9600	384	36	H	.450	.076	33.00	24-16-36
9	13200	528	36	H	.750	.076	46.00	48-11-36
8	18000	720	36	H	.750	.075	63.00	48-15-36
6	26400	1056	36	H	1.050	.075	96.00	48-22-36
4	40200	1608	36	H	.900	.113	143.00	24-67-36
2	72000	2880	36	H	1.500	.113	265.00	48-60-36
1/0	100800	4032	36	H	1.950	.150	376.00	48-84-36

1 H = heavy-film coating

*All measurements are in inches unless otherwise stated.*

# Rectangular Compacted Litz\*

The rectangular compacted Type 8 Litz constructions listed in this section are designed with copper densities from 60 to 75 percent of the cable's cross sectional area. This type Litz is particularly suited for high frequency motor, generator, transformer and inverter windings where limited space necessitates a conductor with excellent fill factor and copper density.

New England Wire has pioneered the development of Type 8 Litz designs including square configurations as well as the rectangular constructions listed. Please consult our design team for the Type 8 designs requiring specific wire sizes or dimensions.

Equivalent AWG	Circular Mil Area	Number of Wires	AWG of Wire	Film Coating <sup>1</sup>	Nominal Width	Nominal Thickness	Nominal LBS/1000 FT	Direct Current Resistance OHMS/1000 FT <sup>^</sup>	Construction
RECOMMENDED OPERATING FREQUENCY - 400 HZ TO 5 KHZ · The following designs utilize monolithic conductors for the base group.									
4	46403	7	12	H	.327	.152	140.0	.262	7X12
3	53032	8	12	H	.374	.152	160.0	.229	8X12
3	59661	9	12	H	.421	.152	180.0	.204	9X12
2	66290	10	12	H	.468	.152	200.0	.184	10X12
2	72919	11	12	H	.515	.152	220.0	.167	11X12
2	79548	12	12	H	.533	.152	240.0	.153	12X12
1	86177	13	12	H	.575	.152	260.0	.141	13X12
1	92806	14	12	H	.619	.152	280.0	.131	14X12
1	99435	15	12	H	.661	.152	300.0	.122	15X12
1/0	106064	16	12	H	.704	.152	320.0	.115	16X12
1/0	112693	17	12	H	.747	.152	341.0	.108	17X12
1/0	119322	18	12	H	.789	.152	361.0	.102	18X12
6	28763	7	14	H	.262	.121	88.0	.416	7X14
5	32872	8	14	H	.299	.121	101.0	.364	8X14
5	36981	9	14	H	.337	.121	113.0	.324	9X14
4	41090	10	14	H	.374	.121	126.0	.291	10X14
4	45199	11	14	H	.392	.121	138.0	.265	11X14
4	49308	12	14	H	.426	.121	151.0	.243	12X14
3	53417	13	14	H	.460	.121	163.0	.224	13X14
3	57526	14	14	H	.495	.121	176.0	.208	14X14
3	61635	15	14	H	.528	.121	189.0	.194	15X14
2	65744	16	14	H	.563	.121	201.0	.182	16X14
2	69853	17	14	H	.597	.121	214.0	.171	17X14
2	73962	18	14	H	.631	.121	226.0	.162	18X14
2	78071	19	14	H	.666	.121	239.0	.153	19X14
1	82180	20	14	H	.700	.121	251.0	.146	20X14
1	86289	21	14	H	.735	.121	264.0	.139	21X14
1	90398	22	14	H	.769	.121	277.0	.132	22X14
1	94507	23	14	H	.802	.121	289.0	.127	23X14
1	98616	24	14	H	.837	.121	302.0	.121	24X14
7	18067	7	16	H	.210	.097	55.7	.663	7X16
7	20648	8	16	H	.240	.097	63.6	.581	8X16
7	23229	9	16	H	.270	.097	71.6	.516	9X16
6	25810	10	16	H	.299	.097	79.5	.464	10X16
6	28391	11	16	H	.329	.097	87.5	.422	11X16
6	30972	12	16	H	.341	.097	95.4	.387	12X16
5	33553	13	16	H	.368	.097	103.0	.357	13X16

1 H = heavy-film coating

\*New England U.S. Patent 4439256

<sup>^</sup> Not for specification purposes.

All measurements are in inches unless otherwise stated.



# Rectangular Compacted Litz\*, continued

Equivalent AWG	Circular Mil Area	Number of Wires	AWG of Wire	Film Coating <sup>1</sup>	Nominal Width	Nominal Thickness	Nominal LBS/1000 FT	Direct Current Resistance OHMS/1000 FT. <sup>^</sup>	Construction
<b>RECOMMENDED OPERATING FREQUENCY - 400 HZ TO 5 KHZ (CONTINUED) - The following designs utilize monolithic conductors for the base group.</b>									
5	36134	14	16	H	.396	.097	111.0	.332	14X16
5	38715	15	16	H	.423	.097	119.0	.310	15X16
4	41296	16	16	H	.451	.097	127.0	.290	16X16
4	43877	17	16	H	.478	.097	135.0	.273	17X16
4	46458	18	16	H	.506	.097	143.0	.258	18X16
4	49039	19	16	H	.534	.097	151.0	.244	19X16
3	51620	20	16	H	.561	.097	159.0	.232	20X16
3	54201	21	16	H	.588	.097	167.0	.221	21X16
3	56782	22	16	H	.616	.097	175.0	.211	22X16
3	59363	23	16	H	.643	.097	183.0	.202	23X16
3	61944	24	16	H	.671	.097	191.0	.194	24X16
10	11368	7	18	H	.168	.078	35.1	1.054	7X18
9	12992	8	18	H	.192	.078	40.2	.923	8X18
9	14616	9	18	H	.216	.078	45.2	.820	9X18
8	16240	10	18	H	.240	.078	50.2	.738	10X18
8	17864	11	18	H	.252	.078	55.2	.671	11X18
8	19488	12	18	H	.273	.078	60.2	.615	12X18
7	21112	13	18	H	.295	.078	65.3	.568	13X18
7	22736	14	18	H	.317	.078	70.3	.527	14X18
7	24360	15	18	H	.339	.078	75.3	.492	15X18
6	25984	16	18	H	.361	.078	80.3	.461	16X18
6	27608	17	18	H	.383	.078	85.3	.434	17X18
6	29232	18	18	H	.405	.078	90.4	.410	18X18
6	30856	19	18	H	.428	.078	95.4	.388	19X18
5	32480	20	18	H	.449	.078	100.0	.369	20X18
5	34104	21	18	H	.472	.078	105.0	.351	21X18
5	35728	22	18	H	.493	.078	110.0	.335	22X18
5	37352	23	18	H	.500	.078	115.0	.321	23X18
5	38976	24	18	H	.538	.078	120.0	.308	24X18
12	7168	7	20	H	.132	.062	22.1	1.670	7X20
11	8192	8	20	H	.149	.062	25.3	1.460	8X20
11	9216	9	20	H	.167	.062	28.4	1.300	9X20
10	10240	10	20	H	.184	.062	31.6	1.170	10X20
10	11264	11	20	H	.201	.062	34.8	1.060	11X20
10	12288	12	20	H	.219	.062	37.9	.974	12X20
9	13312	13	20	H	.236	.062	41.1	.899	13X20
9	14336	14	20	H	.254	.062	44.2	.835	14X20
9	15360	15	20	H	.272	.062	47.4	.779	15X20
8	16384	16	20	H	.289	.062	50.6	.731	16X20
8	17408	17	20	H	.307	.062	53.7	.688	17X20
8	18432	18	20	H	.325	.062	56.9	.650	18X20
8	19456	19	20	H	.342	.062	60.0	.615	19X20
7	20480	20	20	H	.360	.062	63.2	.585	20X20

1 H = heavy-film coating

All measurements are in inches unless otherwise stated.

\*New England U.S. Patent 4439256

<sup>^</sup> Not for specification purposes.

# Rectangular Compacted Litz\*, continued

Equivalent AWG	Circular Mil Area	Number of Wires	AWG of Wire	Film Coating <sup>1</sup>	Nominal Width	Nominal Thickness	Nominal LBS/1000 FT	Direct Current Resistance OHMS/1000 FT	Construction
<b>RECOMMENDED OPERATING FREQUENCY - 400 HZ TO 5 KHZ (CONTINUED) · The following designs utilize monolithic conductors for the base group.</b>									
7	21504	21	20	H	.378	.062	66.4	.557	21X20
7	22528	22	20	H	.395	.062	69.5	.531	22X20
7	23552	23	20	H	.413	.062	72.7	.508	23X20
7	24576	24	20	H	.431	.062	75.8	.487	24X20
14	4480	7	22	H	.108	.050	13.9	2.69	7X22
13	5120	8	22	H	.120	.050	15.9	2.35	8X22
13	5760	9	22	H	.133	.050	17.9	2.09	9X22
12	6401	10	22	H	.147	.050	19.9	1.88	10X22
12	7041	11	22	H	.161	.050	21.9	1.71	11X22
12	7681	12	22	H	.175	.050	23.9	1.57	12X22
11	8321	13	22	H	.189	.050	25.9	1.45	13X22
11	8961	14	22	H	.204	.050	27.9	1.34	14X22
11	9601	15	22	H	.218	.050	29.9	1.25	15X22
10	10241	16	22	H	.232	.050	31.8	1.18	16X22
10	10881	17	22	H	.246	.050	33.8	1.11	17X22
15	3636	9	24	H	.105	.038	11.3	3.30	9X24
14	4040	10	24	H	.116	.038	12.6	2.97	10X24
14	4444	11	24	H	.129	.038	13.9	2.70	11X24
14	4848	12	24	H	.140	.038	15.1	2.48	12X24
13	5252	13	24	H	.152	.038	16.4	2.28	13X24
13	5656	14	24	H	.163	.038	17.6	2.12	14X24
13	6060	15	24	H	.176	.038	18.9	1.98	15X24
12	6464	16	24	H	.187	.038	20.2	1.86	16X24
12	6868	17	24	H	.199	.038	21.4	1.75	17X24
<b>RECOMMENDED OPERATING FREQUENCY - 60 HZ TO 1 KHZ · The following designs utilize 7 strand concentric conductors for the base group.</b>									
2	79576	49	18	H	.495	.233	250.0	.153	7X7X18
1	90944	56	18	H	.559	.233	285.0	.134	8X7X18
1	102312	63	18	H	.624	.233	321.0	.119	9X7X18
1/0	113680	70	18	H	.689	.233	357.0	.107	10X7X18
1/0	125048	77	18	H	.755	.233	392.0	.097	11X7X18
2/0	136416	84	18	H	.820	.233	428.0	.089	12X7X18
4	50176	49	20	H	.396	.187	157.0	.242	7X7X20
3	57344	56	20	H	.448	.187	180.0	.212	8X7X20
3	64512	63	20	H	.500	.187	202.0	.188	9X7X20
2	71680	70	20	H	.552	.187	225.0	.170	10X7X20
2	78848	77	20	H	.604	.187	247.0	.154	11X7X20
1	86016	84	20	H	.657	.187	269.0	.141	12X7X20
1	93184	91	20	H	.709	.187	292.0	.130	13X7X20
1	100352	98	20	H	.768	.187	314.0	.121	14X7X20
1/0	107520	105	20	H	.815	.187	337.0	.113	15X7X20
1/0	114688	112	20	H	.868	.187	359.0	.106	16X7X20

1 H = heavy-film coating

All measurements are in inches unless otherwise stated.

\*New England U.S. Patent 4439256

^ Not for specification purposes.



# Rectangular Compacted Litz\*, continued

Equivalent AWG	Circular Mil Area	Number of Strands	AWG of Strand	Film Coating <sup>1</sup>	Nominal Width	Nominal Thickness	Nominal LBS./1000 FT.	Direct Current Resistance OHMS/1000 FT*.	Construction
RECOMMENDED OPERATING FREQUENCY - 60 HZ TO 1 KHZ (CONTINUED) - The following designs utilize 7 strand concentric conductors for the base group.									
6	31368	49	22	H	.317	.150	99.0	.389	7X7X22
5	35848	56	22	H	.359	.150	113.0	.341	8X7X22
5	40329	63	22	H	.400	.150	127.0	.303	9X7X22
4	44810	70	22	H	.442	.150	141.0	.273	10X7X22
4	49291	77	22	H	.484	.150	156.0	.248	11X7X22
3	53772	84	22	H	.526	.150	170.0	.227	12X7X22
3	58253	91	22	H	.568	.150	184.0	.210	13X7X22
3	62734	98	22	H	.611	.150	198.0	.195	14X7X22
2	67215	105	22	H	.653	.150	212.0	.182	15X7X22
2	71696	112	22	H	.695	.150	226.0	.170	16X7X22
2	76177	119	22	H	.738	.150	240.0	.160	17X7X22
2	80658	126	22	H	.780	.150	255.0	.151	18X7X22
1	85139	133	22	H	.823	.150	269.0	.143	19X7X22
1	89614	140	22	H	.864	.150	283.0	.136	20X7X22
8	19796	49	24	H	.257	.121	62.7	.615	7X7X24
7	22624	56	24	H	.290	.121	71.6	.538	8X7X24
7	25452	63	24	H	.324	.121	80.6	.478	9X7X24
6	28280	70	24	H	.357	.121	89.5	.430	10X7X24
6	31108	77	24	H	.391	.121	98.5	.391	11X7X24
5	33936	84	24	H	.425	.121	107.0	.359	12X7X24
5	36764	91	24	H	.459	.121	116.0	.331	13X7X24
5	39592	98	24	H	.494	.121	125.0	.307	14X7X24
4	42420	105	24	H	.528	.121	134.0	.287	15X7X24
4	45248	112	24	H	.562	.121	143.0	.269	16X7X24
4	48076	119	24	H	.596	.121	152.0	.253	17X7X24
4	50904	126	24	H	.630	.121	161.0	.239	18X7X24
3	53732	133	24	H	.665	.121	170.0	.226	19X7X24
3	56560	140	24	H	.699	.121	179.0	.215	20X7X24
3	59388	147	24	H	.734	.121	187.0	.205	21X7X24
3	62216	154	24	H	.767	.121	197.0	.196	22X7X24
2	65044	161	24	H	.801	.121	206.0	.187	23X7X24
2	67872	168	24	H	.836	.121	215.0	.179	24X7X24
10	12390	49	26	H	.206	.097	39.7	.987	7X7X26
9	14160	56	26	H	.233	.097	45.4	.864	8X7X26
9	15930	63	26	H	.260	.097	51.1	.768	9X7X26
8	17700	70	26	H	.287	.097	56.8	.691	10X7X26
8	19470	77	26	H	.314	.097	62.4	.628	11X7X26
7	21240	84	26	H	.342	.097	68.1	.576	12X7X26
7	23010	91	26	H	.369	.097	73.8	.532	13X7X26
7	24780	98	26	H	.397	.097	79.5	.494	14X7X26
6	26550	105	26	H	.424	.097	85.2	.461	15X7X26
6	28320	112	26	H	.452	.097	90.8	.432	16X7X26
6	30090	119	26	H	.479	.097	96.5	.407	17X7X26
6	31860	126	26	H	.507	.097	102.0	.384	18X7X26
5	33630	133	26	H	.534	.097	108.0	.364	19X7X26

1 H = heavy-film coating

All measurements are in inches unless otherwise stated.

\*New England U.S. Patent 4439256

^ Not for specification purposes.

# Rectangular Compacted Litz\*, continued

Equivalent AWG	Circular Mil Area	Number of Wires	AWG of Wire	Film Coating <sup>1</sup>	Nominal Width	Nominal Thickness	Nominal LBS/1000 FT	Direct Current Resistance OHMS/1000 FT	Construction
<b>RECOMMENDED OPERATING FREQUENCY - 60 HZ TO 1 KHZ (CONTINUED) · The following designs utilize 7 strand concentric conductors for the base group.</b>									
5	35400	140	26	H	.562	.097	114.0	.346	20X7X26
5	37170	147	26	H	.590	.097	119.0	.329	21X7X26
5	38940	154	26	H	.617	.097	125.0	.314	22X7X26
5	40710	161	26	H	.644	.097	131.0	.300	23X7X26
4	42480	168	26	H	.672	.097	136.0	.288	24X7X26
<b>RECOMMENDED OPERATING FREQUENCY - 60 HZ TO 10 KHZ · The following designs utilize 7 strand concentric conductors for the base group.</b>									
12	7784	49	28	H	.151	.078	25.1	1.50	7X7X28
11	8896	56	28	H	.173	.078	28.6	1.360	8X7X28
11	10008	63	28	H	.194	.078	32.2	1.210	9X7X28
10	11120	70	28	H	.216	.078	35.8	1.090	10X7X28
10	12232	77	28	H	.238	.078	39.4	.991	11X7X28
9	13344	84	28	H	.259	.078	43.0	.909	12X7X28
9	14456	91	28	H	.281	.078	46.6	.839	13X7X28
9	15568	98	28	H	.302	.078	50.1	.779	14X7X28
8	16680	105	28	H	.324	.078	53.7	.727	15X7X28
8	17792	112	28	H	.346	.078	57.3	.681	16X7X28
8	18904	119	28	H	.367	.078	60.9	.641	17X7X28
8	20016	126	28	H	.389	.078	64.5	.606	18X7X28
7	21128	133	28	H	.410	.078	68.0	.574	19X7X28
7	22240	140	28	H	.432	.078	71.6	.545	20X7X28
7	23352	147	28	H	.453	.078	75.2	.519	21X7X28
7	24464	154	28	H	.475	.078	78.8	.496	22X7X28
7	25576	161	28	H	.497	.078	82.4	.474	23X7X28
14	4900	49	30	H	.122	.063	15.8	2.48	7X7X30
13	5600	56	30	H	.139	.063	18.1	2.17	8X7X30
13	6300	63	30	H	.157	.063	20.3	1.93	9X7X30
12	7000	70	30	H	.174	.063	22.6	1.74	10X7X30
12	7700	77	30	H	.191	.063	24.9	1.58	11X7X30
11	8400	84	30	H	.209	.063	27.1	1.45	12X7X30
11	9100	91	30	H	.226	.063	29.4	1.34	13X7X30
11	9800	98	30	H	.244	.063	31.6	1.24	14X7X30
10	10500	105	30	H	.261	.063	33.9	1.14	15X7X30
10	11200	112	30	H	.278	.063	36.2	1.09	16X7X30
10	11900	119	30	H	.296	.063	38.4	1.02	17X7X30

1 H = heavy-film coating

All measurements are in inches unless otherwise stated.

\*New England U.S. Patent 4439256

^ Not for specification purposes.



## Rectangular Compacted Litz\*, continued

Equivalent AWG	Circular Mil Area	Number of Wires	AWG of Wire	Film Coating <sup>1</sup>	Nominal Width	Nominal Thickness	Nominal LBS/1000 FT	Direct Current Resistance OHMS/1000FT	Construction
RECOMMENDED OPERATING FREQUENCY - 10 HZ TO 50 KHZ · The following designs utilize 7 strand concentric and bonded* conductors for the base group.									
17	2470	49	33	H	.082	.045	8.0	4.97	7X7X33
16	2822	56	33	H	.094	.045	9.2	4.35	8X7X33
16	3176	63	33	H	.106	.045	10.3	3.86	9X7X33
15	3529	70	33	H	.118	.045	11.4	3.47	10X7X33
15	3882	77	33	H	.129	.045	12.6	3.16	11X7X33
14	4234	84	33	H	.141	.045	13.7	2.90	12X7X33
14	4587	91	33	H	.153	.045	14.9	2.68	13X7X33
14	4940	98	33	H	.165	.045	16.0	2.48	14X7X33
13	5293	105	33	H	.177	.045	17.2	2.32	15X7X33
13	5646	112	33	H	.188	.045	18.3	2.17	16X7X33
13	5999	119	33	H	.200	.045	19.5	2.05	17X7X33
20	1225	49	36	H	.058	.032	4.0		7X7X36
19	1400	56	36	H	.066	.032	4.6	10.14	8X7X36
19	1575	63	36	H	.074	.032	5.1	8.87	9X7X36
18	1750	70	36	H	.082	.032	5.7	7.88	10X7X36
18	1925	77	36	H	.091	.032	6.3	7.10	11X7X36
17	2100	84	36	H	.099	.032	6.8	6.28	12X7X36
17	2275	91	36	H	.107	.032	7.4	5.91	13X7X36
17	2450	98	36	H	.115	.032	8.0	5.46	14X7X36
16	2625	105	36	H	.124	.032	8.6	5.07	15X7X36
16	2800	112	36	H	.132	.032	9.1	4.73	16X7X36
16	2975	119	36	H	.140	.032	9.7	4.43	17X7X36
								4.17	

1 H = heavy-film coating

All measurements are in inches unless otherwise stated.

\*New England U.S. Patent 4439256

^ Not for specification purposes.

www.newenglandwire.com

Tel: 603.838.6624

# Single Film Coated - Round

AWG Size	Bare Wire Diameter Nominal	Film Addition Min	Film Addition Max.	Min OD	Nominal OD	Max OD	Weight @ 20°C - 68° F LBS/1000 FT Nominal	Weight @ 20°C - 68° F FT/LB Nominal	Resistance @ 20°C - 68° F OHMS/1000 FT Nominal	Resistance @ 20°C - 68° F OHMS/LB Nominal	Wires Per SQ Inch
8	.1285	.0016	.0026	.1288	.1306	.1324	50.23	19.91	.6281	.0125	59
9	.1144	.0016	.0026	.1149	.1165	.1181	39.80	25.13	.7925	.01991	74
10	.1019	.0015	.0025	.1024	.1039	.1054	31.57	31.68	.9987	.03163	93
11	.0907	.0015	.0025	.0913	.0927	.0941	25.05	39.92	1.261	.0503	116
12	.0808	.0014	.0024	.0814	.0827	.0840	19.93	50.18	1.588	.0797	146
13	.0720	.0014	.0023	.0727	.0739	.0750	15.81	63.25	2.001	.1266	183
14	.0641	.0016	.0023	.0651	.0658	.0666	12.50	80.00	2.524	.2019	230
15	.0571	.0015	.0022	.0580	.0587	.0594	9.95	100.50	3.181	.3197	288
16	.0508	.0014	.0021	.0517	.0524	.0531	7.89	126.7	4.018	.5093	363
17	.0453	.0014	.0020	.0462	.0468	.0475	6.26	159.7	5.054	.8073	455
18	.0403	.0013	.0019	.0412	.0418	.0424	4.97	201.2	6.386	1.2849	572
19	.0359	.0012	.0019	.0367	.0373	.0379	3.95	253.2	8.046	2.037	715
20	.0320	.0012	.0018	.0329	.0334	.0339	3.13	319.5	10.13	3.2364	896
21	.0285	.0011	.0018	.0293	.0298	.0303	2.483	402.7	12.77	5.143	1119
22	.0253	.0011	.0017	.0261	.0266	.0270	1.970	507.6	16.20	8.223	1403
23	.0226	.0010	.0016	.0234	.0238	.0243	1.565	639.0	20.30	12.971	1751
24	.0201	.0010	.0015	.0209	.0213	.0217	1.240	806.5	25.67	20.702	2204
25	.0179	.0009	.0014	.0186	.0190	.0194	.988	1012.1	32.37	32.763	2741
26	.0159	.0009	.0013	.0166	.0170	.0173	.784	1276	41.02	52.32	3460
27	.0142	.0008	.0013	.0149	.0152	.0156	.623	1605	51.44	82.57	4272
28	.0126	.0008	.0012	.0133	.0136	.0140	.495	2020	65.31	131.94	5407
29	.0113	.0007	.0012	.0119	.0122	.0126	.394	2538	81.21	206.12	6610
30	.0100	.0007	.0011	.0106	.0109	.0112	.312	3205	103.7	332.37	8417
31	.0089	.0006	.0010	.0094	.0097	.0100	.248	4032	130.9	527.8	10628
32	.0080	.0006	.0010	.0085	.0088	.0091	.1966	5086	162.0	824.0	12913
33	.0071	.0005	.0009	.0075	.0078	.0081	.1570	6369	205.7	1310	16437
34	.0063	.0005	.0008	.0067	.0070	.0072	.1244	8039	261.3	2100	20408
35	.0056	.0004	.0007	.0059	.0062	.0064	.0989	10111	330.7	3343	26015
36	.0050	.0004	.0007	.0053	.0056	.0058	.0788	12690	414.8	5264	31888
37	.0045	.0003	.0006	.0047	.0050	.0052	.0624	16026	512.1	8207	40000
38	.0040	.0003	.0006	.0042	.0045	.0047	.0494	20243	648.2	13121	49383
39	.0035	.0002	.0005	.0036	.0039	.0041	.0393	25445	846.6	21542	65746
40	.0031	.0002	.0005	.0032	.0035	.0037	.0313	31949	1079	34473	81633
41	.0028	.0002	.0004	.0029	.0031	.0033	.02470	40486	1323	53563	104058
42	.0025	.0002	.0004	.0026	.0028	.0030	.01946	51387	1659	85252	127551
43	.0022	.0002	.0003	.0023	.0025	.0026	.01548	64599	2143	138437	160000
44	.0020	.0001	.0003	.0020	.0022	.0024	.01233	81103	2593	210300	206611
45	.00176	.0001	.00022	.00179	.0019	.00205	.00965	103626	3348	346943	345304
46	.00157	.0001	.00021	.00161	.00173	.00185	.00767	130378	4207	548501	420521
47	.00140	.0001	.00024	.00145	.00158	.00170	.00615	162601	5291	860325	510204
48	.00124	.0001	.00021	.00129	.00140	.00150	.00487	205338	6745	1385010	649773

All measurements are in inches unless otherwise stated.

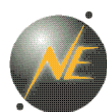



# Heavy Film Coated - Round

AWG Size	Bare Wire Diameter Nominal	Film Addition Min	Film Addition Max.	Min OD	Nominal OD	Max OD	Weight @ 20°C - 68° F LBS/1000 FT Nominal	Weight @ 20°C - 68° F FT/LB Nominal	Resistance @ 20°C - 68° F OHMS/1000 FT Nominal	Resistance @ 20°C - 68° F OHMS/LB Nominal	Wires Per SQ Inch
8	.1285	.0033	.0044	.1305	.1319	.1332	50.42	19.83	.6281	.01246	57
9	.1144	.0032	.0043	.1165	.1177	.1189	39.97	25.02	.7925	.01983	72
10	.1019	.0031	.0042	.1050	.1056	.1061	31.72	31.53	.9987	.03148	90
11	.0907	.0030	.0041	.0928	.0938	.0948	25.18	39.71	1.261	.0501	112
12	.0808	.0029	.0039	.0829	.0837	.0847	20.03	49.93	1.588	.0793	141
13	.0720	.0028	.0038	.0741	.0749	.0757	15.90	62.89	2.001	.1258	176
14	.0641	.0032	.0037	.0667	.0675	.0682	12.57	79.55	2.524	.2008	221
15	.0571	.0030	.0036	.0595	.0602	.0609	10.01	99.90	3.181	.3178	276
16	.0508	.0029	.0035	.0532	.0539	.0545	7.95	125.79	4.018	.5054	344
17	.0453	.0028	.0034	.0476	.0482	.0488	6.32	158.23	5.054	.7997	429
18	.0403	.0026	.0033	.0425	.0431	.0437	5.02	199.2	6.386	1.2721	536
19	.0359	.0025	.0032	.0380	.0386	.0391	3.99	250.6	8.046	2.0165	668
20	.0320	.0023	.0030	.0340	.0346	.0351	3.16	316.5	10.13	3.2057	835
21	.0285	.0022	.0029	.0304	.0309	.0314	2.51	398.4	12.77	5.088	1041
22	.0253	.0021	.0028	.0271	.0276	.0281	1.99	502.5	16.20	8.141	1303
23	.0226	.0020	.0027	.0244	.0249	.0253	1.59	628.9	20.30	12.767	1613
24	.0201	.0019	.0026	.0218	.0223	.0227	1.260	793.7	25.67	20.373	1993
25	.0179	.0018	.0025	.0195	.0199	.0203	1.005	995.0	32.37	32.209	2475
26	.0159	.0017	.0024	.0174	.0178	.0182	.799	1252	41.02	51.34	3086
27	.0142	.0016	.0022	.0157	.0161	.0164	.634	1577	51.44	81.14	3858
28	.0126	.0016	.0021	.0141	.0144	.0147	.504	1984	65.31	129.58	4823
29	.0113	.0015	.0020	.0127	.0130	.0133	.401	2494	81.21	202.52	5917
30	.0100	.0014	.0019	.0113	.0116	.0119	.318	3145	103.7	326.10	7432
31	.0089	.0013	.0018	.0101	.0105	.0108	.254	3937	130.9	515.4	9070
32	.0080	.0012	.0017	.0091	.0095	.0098	.2019	4953	162.0	802.4	11080
33	.0071	.0011	.0016	.0081	.0085	.0088	.1611	6207	205.7	1276.8	13841
34	.0063	.0010	.0014	.0072	.0075	.0078	.1269	7880	261.3	2059.1	17778
35	.0056	.0009	.0013	.0064	.0067	.0070	.1010	9901	330.7	3274.3	22277
36	.0050	.0008	.0012	.0057	.0060	.0063	.0803	12453	414.8	5166	27778
37	.0045	.0008	.0011	.0052	.0055	.0057	.0641	15601	512.1	7989	33058
38	.0040	.0007	.0010	.0046	.0049	.0051	.0509	19646	648.2	12735	41649
39	.0035	.0006	.0009	.0040	.0043	.0045	.0403	24814	846.6	21007	54083
40	.0031	.0006	.0008	.0036	.0038	.0040	.0319	31348	1079	33824	69252
41	.0028	.0005	.0007	.0032	.0034	.0036	.0252	39683	1323	52500	86505
42	.0025	.0004	.0006	.0028	.0030	.0032	.0199	50251	1659	83367	111111
43	.0022	.0004	.0006	.0025	.0027	.0029	.0159	62893	2143	134780	137174
44	.0020	.0004	.0006	.0023	.0025	.0027	.0127	78740	2593	204173	160000

All measurements are in inches unless otherwise stated.

[www.newenglandwire.com](http://www.newenglandwire.com)

Tel: 603.838.6624

© 2005 New England Wire Technologies

# FILM INSULATIONS

INSULATION	RATING	AWG	ADVANTAGES	CONSIDERATIONS
Polyvinyl Formal	Class 105 MW 15-C	14 - 50	<ul style="list-style-type: none"> <li>- Excellent abrasion resistance</li> <li>- Excellent compatibility with transformer oils</li> <li>- Good electrical properties</li> <li>- Used in Cryogenic Applications</li> </ul>	<ul style="list-style-type: none"> <li>- Must be stripped before soldering</li> <li>- Should be annealed before application of varnish</li> </ul>
Polyurethane	Class 155 MW 79-C  Class 180 MW 82-C	30 - 50  24 - 50	<ul style="list-style-type: none"> <li>- Excellent electrical properties for high Q coils</li> <li>- Easily solderable 390°C/360°C</li> <li>- Excellent film adhesion &amp; flexibility</li> <li>- Good moisture &amp; chemical resistance</li> </ul>	<ul style="list-style-type: none"> <li>- Not recommended for applications with the possibility of severe thermal overload</li> </ul>
Polyurethane-Nylon	Class 155 MW 80-C  Class 180 MW 83-C	10 - 46  25 - 46	<ul style="list-style-type: none"> <li>- Good electrical properties</li> <li>- Easily solderable 430°C/390°C</li> <li>- Excellent film adhesion &amp; flexibility</li> <li>- Improved chemical &amp; mechanical resistance from nylon topcoat</li> <li>- Nylon overcoat provides low coefficient of friction</li> </ul>	<ul style="list-style-type: none"> <li>- Not recommended for applications with the possibility of severe thermal overload</li> <li>- Nylon topcoat is hygroscopic</li> </ul>
Solderable Polyester	Class 180 MW 77-C	14 - 50	<ul style="list-style-type: none"> <li>- Solderable 470°C</li> <li>- Excellent thermal properties</li> <li>- Good electrical properties</li> <li>- Good compatibility with varnishes &amp; solvents</li> <li>- Improved thermal overload</li> <li>- Good moisture resistance</li> </ul>	<ul style="list-style-type: none"> <li>- Low abrasion resistance compared to Nylon &amp; amide imide topcoat materials</li> <li>- Preheat before varnishing is recommended</li> </ul>
Solderable Polyester Nylon	Class 180 MW 78-C	14-50	<ul style="list-style-type: none"> <li>- Solderable 470°C</li> <li>- Excellent thermal properties</li> <li>- Good electrical properties</li> <li>- Good compatibility with varnishes &amp; solvents</li> <li>- Improved thermal overload</li> <li>- Good moisture resistance</li> <li>- Nylon overcoat provides low coefficient of friction</li> </ul>	<ul style="list-style-type: none"> <li>- Nylon topcoat is hygroscopic</li> <li>- Preheat before varnishing is recommended</li> </ul>
Polyester(amide)(imide)	Class 200 MW 74-C	34 - 44	<ul style="list-style-type: none"> <li>- Excellent flexibility &amp; abrasion resistance</li> <li>- Excellent thermal overload</li> <li>- Excellent dielectric strength</li> <li>- Excellent moisture resistance</li> <li>- Good chemical resistance</li> </ul>	<ul style="list-style-type: none"> <li>- Must be stripped before soldering</li> <li>- Not recommended for use in oil-filled transformers</li> <li>- Preheat before varnishing</li> </ul>
Polyester/Poly-amideimide Overcoat	Class 200 MW 35-C	8 - 33	<ul style="list-style-type: none"> <li>- Excellent flexibility &amp; abrasion resistance</li> <li>- Excellent thermal overload</li> <li>- Excellent dielectric strength</li> <li>- Excellent moisture resistance</li> <li>- Good chemical resistance</li> </ul>	<ul style="list-style-type: none"> <li>- Must be stripped before soldering</li> <li>- Preheat before varnishing</li> </ul>
Polyimide	Class 240 MW 16-C	10 - 30	<ul style="list-style-type: none"> <li>- Excellent flexibility</li> <li>- Excellent thermal overload</li> <li>- Excellent radiation resistance</li> <li>- Excellent chemical compatibility</li> <li>- High dielectric strength</li> <li>- Adequate abrasion resistance</li> <li>- Low outgas</li> </ul>	<ul style="list-style-type: none"> <li>- Must be stripped before soldering</li> <li>- Must be annealed before varnishing</li> <li>- Will solvent craze</li> </ul>



# FIBER & TAPE INSULATIONS

Insulation	Recommended Max. Operating Temperature	Advantages	Limitations
Cotton	105°C	<ol style="list-style-type: none"> <li>1. Low cost serving.</li> <li>2. Good resistance to abrasion.</li> </ol>	<ol style="list-style-type: none"> <li>1. Poor space factor compared to Nylon or Celanese.</li> <li>2. Non-solderable.</li> </ol>
Nylon	155°C	<ol style="list-style-type: none"> <li>1. Good space factor.</li> <li>2. Excellent abrasion resistance.</li> <li>3. Solderable.</li> </ol>	<ol style="list-style-type: none"> <li>1. Hygroscopic</li> </ol>
Dacron® (POLYESTER)	155°C	<ol style="list-style-type: none"> <li>1. Good abrasion resistance.</li> <li>2. Solderable.</li> <li>3. Slightly higher maximum operating temperature than nylon.</li> </ol>	<ol style="list-style-type: none"> <li>1. Better space factor than Cotton or Glass but poorer space factor than Nylon.</li> </ol>
Nomex® (HI-TEMP Aramid)	250°C	<ol style="list-style-type: none"> <li>1. Good space factor.</li> <li>2. Good electrical properties at high temperatures.</li> </ol>	<ol style="list-style-type: none"> <li>1. Non-solderable.</li> <li>2. Higher cost than other fibers.</li> </ol>
Glass	260°C	<ol style="list-style-type: none"> <li>1. Good electrical properties at high temperatures.</li> </ol>	<ol style="list-style-type: none"> <li>1. Space factor equivalent to Cotton.</li> <li>2. Non-solderable.</li> </ol>

Tape Insulation	Recommended Max. Use Temperature	Characteristics
Polyester (PET) Mylar® (heat sealable grades available)	135° C	<ol style="list-style-type: none"> <li>1. High dielectric strength.</li> <li>2. Good abrasion often used as binder or moisture barrier under extruded jackets and textile serves or braids.</li> </ol>
Nomex® (aromatic polyamide)	200° C (Up to 220° C under certain conditions.)	<ol style="list-style-type: none"> <li>1. Excellent thermal properties.</li> <li>2. Excellent electrical properties.</li> <li>3. Excellent compatibility with varnishes, adhesives and transformer fluids.</li> <li>4. Thinner grades are flexible.</li> <li>5. Good resistance to tearing and abrasion.</li> </ol>
Polyimide Kapton® (Heat sealable & adhesive grades available)	240° C (Up to 400° C under certain conditions.)	<ol style="list-style-type: none"> <li>1. Very high dielectric strength.</li> <li>2. Very good chemical resistance.</li> <li>3. UL 94 V-0 flame rating.</li> <li>4. Excellent mechanical properties.</li> </ol>
Fiberglass Cloth	Ultimate operating temperature determined by application & glass type.	<ol style="list-style-type: none"> <li>1. Excellent electrical properties at high temperatures.</li> <li>2. Conformable.</li> <li>3. Varnish compatible grades available.</li> <li>4. Excellent solvent resistance.</li> </ol>
Mica	Ultimate operating temperature determined by application & glass type.	<ol style="list-style-type: none"> <li>1. Excellent electrical properties at high temperatures.</li> <li>2. Flame resistant.</li> <li>3. Retains useful electrical properties during &amp; after exposure to fire.</li> </ol>

NOTE: Dacron®, Nomex®, Mylar® and Kapton® are DuPont Registered Trademarks.

# NEWind® Specialty Winding Wire

## TECHNICAL INFORMATION

The most common winding wire is magnet wire in either its single-end or stranded “Litz” form. Magnet wire coating, however is generally not sufficient for insulating between winding turns, separate windings and between the winding and ground as the magnet wire coating can easily be damaged. It is for this reason that additional interleaved insulation is needed.

NEWind® Specialty Winding Wire eliminates the need for this additional insulation by insulating conductors with thin layers of insulation extruded in single (Basic), double (Supplemental) or triple (Reinforced) layers. Basic NEWind® is recommended when a rating of 600 Vpk and the smallest possible diameter are required. Supplemental and Reinforced NEWind® are used where a more rugged product is required to withstand mechanical handling and maintain an electrical rating up to 1000 Vpk. These products are also approved under our NE-F1 Electrical Insulation System.

Multiple Insulation on Complex Bundles



Multiple Insulation on Single Strand



## PRODUCT DETAILS

- UL 60950/IEC 60950 Annex U Approved
- UL 1446 Electrical Insulation System: NE-F1 - Class F (155°C)
- Single-End, Stranded and Litz Conductors
- Supplementary and Reinforced Insulations

## MATERIAL PROPERTIES

	ETFE	FEP	PFA
Temperature Rating*	155°C	180°C	200°C*
Layer Thickness Basic (Minimum)	.0015"	.002"	.002"
Total Thickness Supplementary (Minimum)	.003"	.004"	.004"
Total Thickness Reinforced (Minimum)	.0045"	.006"	.006"

\*UL60950 & VDE 60950 have a maximum temperature rating of 180°C Class H.



# NEWind® - Solid/PFA Insulated Conductors

**DESCRIPTION:** Specialty winding wire for transformers and coils that doesn't require interleaving insulation between layers.

**Conductor Material:** Solid Copper

**Insulation Thickness:** .002" min per layer

Note: .0015" min per layer available as custom design.

**Voltage Rating:** Single layer 600 Vpk

Double & Triple layers 1000 Vpk

**Temperature Rating:** UL/VDE Class H 180°C

**Dielectric Strength:** 2000 V/mil nominal

**Single Layer:** UL 60950 Annex U UL File E205791

**Double Layer:** UL 60950 Annex U UL File E205791

IEC 60950 Annex U VDE Reg. No.135446

**Triple Layer:** UL 60950 Annex U UL File E205791

IEC 60950 Annex U VDE Reg. No.135447

CONDUCTOR	DC RESISTANCE		SINGLE INSULATION			DOUBLE INSULATION			TRIPLE INSULATION			
	AWG	O.D.	Bare Copper	Tinned Copper	PART NUMBER	O.D.	LBS/1000 FT	PART NUMBER	O.D.	LBS/1000 FT	PART NUMBER	O.D.
18	.0403	6.516	6.995	W18S2.OPXTC1A	.0443	5.061	W18D2.OPXXTC1A	.463	5.217	W18T2.OPXXTC1A	.0493	5.383
19	.0359	8.211	8.815	W19S2.OPXTC1A	.0389	4.031	W19D2.OPXXTC1A	.419	4.171	W19T2.OPXXTC1A	.0449	4.322
20	.0320	10.330	11.090	W20S2.OPXTC1A	.0350	3.216	W20D2.OPXXTC1A	.380	3.343	W20T2.OPXXTC1A	.0410	3.480
21	.0285	13.030	13.990	W21S2.OPXTC1A	.0315	2.563	W21D2.OPXXTC1A	.345	2.677	W21T2.OPXXTC1A	.0375	2.802
22	.0253	16.530	17.750	W22S2.OPXTC1A	.0283	2.031	W22D2.OPXXTC1A	.313	2.137	W22T2.OPXXTC1A	.0343	2.248
23	.0226	20.720	22.240	W23S2.OPXTC1A	.0256	1.630	W23D2.OPXXTC1A	.286	1.724	W23T2.OPXXTC1A	.0316	1.828
24	.0201	26.190	28.120	W24S2.OPXTC1A	.0231	1.298	W24D2.OPXXTC1A	.261	1.383	W24T2.OPXXTC1A	.0291	1.479
25	.0179	33.030	35.460	W25S2.OPXTC1A	.0209	1.037	W25D2.OPXXTC1A	.239	1.115	W25T2.OPXXTC1A	.0269	1.203
26	.0159	41.860	44.940	W26S2.OPXTC1A	.0189	.826	W26D2.OPXXTC1A	.219	.897	W26T2.OPXXTC1A	.0249	.978
27	.0142	52.480	56.340	W27S2.OPXTC1A	.0172	.665	W27D2.OPXXTC1A	.202	.730	W27T2.OPXXTC1A	.0232	.805
28	.0126	66.660	71.560	W28S2.OPXTC1A	.0156	.530	W28D2.OPXXTC1A	.186	.589	W28T2.OPXXTC1A	.0216	.659
29	.0113	82.880	88.970	W29S2.OPXTC1A	.0143	.431	W29D2.OPXXTC1A	.173	.486	W29T2.OPXXTC1A	.0203	.551
30	.0100	105.800	113.600	W30S2.OPXTC1A	.0130	.343	W30D2.OPXXTC1A	.160	.393	W30T2.OPXXTC1A	.0190	.454
31	.0089	133.900	143.800	W31S2.OPXTC1A	.0119	.276	W31D2.OPXXTC1A	.149	.322	W31T2.OPXXTC1A	.0179	.379
32	.0080	166.200	178.400	W32S2.OPXTC1A	.0110	.227	W32D2.OPXXTC1A	.140	.270	W32T2.OPXXTC1A	.0170	.324
33	.0071	211.700	228.200	W33S2.OPXTC1A	.0101	.182	W33D2.OPXXTC1A	.131	.223	W33T2.OPXXTC1A	.0161	.273
34	.0063	269.800	289.600	W34S2.OPXTC1A	.0093	.147	W34D2.OPXXTC1A	.123	.185	W34T2.OPXXTC1A	.0153	.233
35	.0056	342.800	368.100	W35S2.OPXTC1A	.0086	.120	W35D2.OPXXTC1A	.116	.155	W35T2.OPXXTC1A	.0146	.200
36	.0050	431.900	463.700	W36S2.OPXTC1A	.0080	.098	W36D2.OPXXTC1A	.110	.131	W36T2.OPXXTC1A	.0140	.175
37	.0045	535.700	575.100	W37S2.OPXTC1A	.0075	.082	W37D2.OPXXTC1A	.105	.113	W37T2.OPXXTC1A	.0135	.155
38	.0040	681.900	732.000	W38S2.OPXTC1A	.0070	.068	W38D2.OPXXTC1A	.100	.097	W38T2.OPXXTC1A	.0130	.137
39	.0035	897.100	963.100	W39S2.OPXTC1A	.0065	.054	W39D2.OPXXTC1A	.095	.082	W39T2.OPXXTC1A	.0125	.120
40	.0031	1152.000	1237.000	W40S2.OPXTC1A	.0061	.045	W40D2.OPXXTC1A	.091	.071	W40T2.OPXXTC1A	.0121	.108

- NOTES: 1. Double and triple insulated conductors are included in UL approved Electrical Insulation System designated as NE-F1.  
 2. Conductor DC resistance is provided as maximum Ohms/1000 Ft @ 20°C.  
 3. Our standard colors for these products include: clear, white, black, red, green, yellow, blue, brown, orange, gray and violet.  
 Most are RoHS Compliant; please contact our design team to discuss your specific requirement.

Use of NEWind® Specialty Winding insulated conductors result in much smaller transformers due to decrease in number of winding wires required and removal of barrier tape and interleaved insulation tapes. Available in single layer of insulation, Supplementary (double layer) and Reinforced (triple layer) styles.

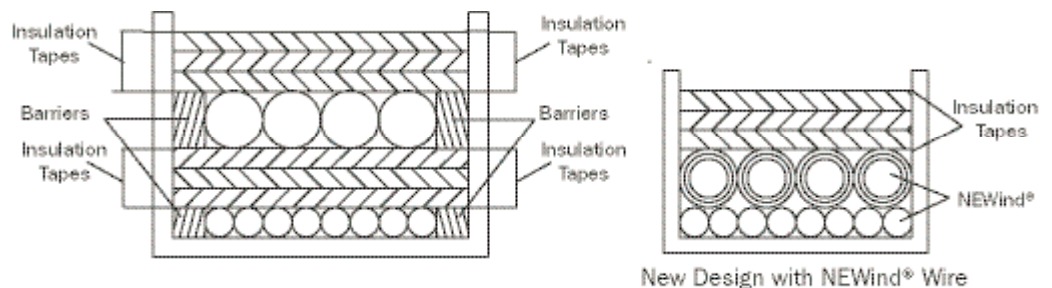

**USE:** Telecommunication devices, laptop computers, digital cameras, games and other electronic devices such as electronic transformers, power adapters, switching mode power supply modules, battery chargers for mobile phones, motors and coils.

All measurements are in inches unless otherwise stated.

[www.newenglandwire.com](http://www.newenglandwire.com)  
 Tel: 603.838.6624

# NEWind® - Solid/FEP Insulated Conductors

**DESCRIPTION:** Specialty winding wire for transformers and coils that doesn't require interleaving insulation between layers.

**Conductor Material:** Solid Copper

**Insulation Thickness:** .002" min per layer

**Voltage Rating:** Basic - 600 Vpk

Supplemental & Reinforced - 1000 Vpk

**Temperature Rating:** UL/VDE Class H 180° C

**Dielectric Strength:** 2000 V/mil nominal

**Single Layer:** UL 60950 Annex U

**Double Layer:** UL 60950 Annex U

IEC 60950 Annex U

**Triple Layer:** UL 60950 Annex U

IEC 60950 Annex U

UL File E205791

UL File E205791

VDE Reg. No. 135443

UL File E205791

VDE Reg. No. 135441

CONDUCTOR		DC RESISTANCE		SINGLE INSULATION		DOUBLE INSULATION		TRIPLE INSULATION				
AWG	O.D.	Bare Copper	Tinned Copper	PART NUMBER	O.D.	LBS/ 1000 FT	PART NUMBER	O.D.	LBS/ 1000 FT	PART NUMBER	O.D.	LBS/ 1000 FT
18	.0403	6.516	6.995	W18S2.0FXTC1A	.0443	5.164	W18D2.0FXTC1A	.0483	5.435	W18T2.0FXXTTC1A	.0523	5.730
19	.0359	8.211	8.815	W19S2.0FXTC1A	.0399	4.123	W19D2.0FXTC1A	.0439	4.369	W19T2.0FXXTTC1A	.0479	4.637
20	.0320	10.330	11.090	W20S2.0FXTC1A	.0360	3.299	W20D2.0FXTC1A	.0400	3.521	W20T2.0FXXTTC1A	.0440	3.767
21	.0285	13.030	13.990	W21S2.0FXTC1A	.0325	2.637	W21D2.0FXTC1A	.0365	2.839	W21T2.0FXXTTC1A	.0405	3.065
22	.0253	16.530	17.750	W22S2.0FXTC1A	.0293	2.097	W22D2.0FXTC1A	.0333	2.281	W22T2.0FXXTTC1A	.0373	2.487
23	.0226	20.720	22.240	W23S2.0FXTC1A	.0266	1.690	W23D2.0FXTC1A	.0306	1.858	W23T2.0FXXTTC1A	.0346	2.049
24	.0201	26.190	28.120	W24S2.0FXTC1A	.0241	1.352	W24D2.0FXTC1A	.0281	1.505	W24T2.0FXXTTC1A	.0321	1.681
25	.0179	33.030	35.460	W25S2.0FXTC1A	.0219	1.086	W25D2.0FXTC1A	.0259	1.226	W25T2.0FXXTTC1A	.0299	1.390
26	.0159	41.860	44.940	W26S2.0FXTC1A	.0199	.870	W26D2.0FXTC1A	.0239	.998	W26T2.0FXXTTC1A	.0279	1.150
27	.0142	52.480	56.340	W27S2.0FXTC1A	.0182	.705	W27D2.0FXTC1A	.0222	.824	W27T2.0FXXTTC1A	.0262	.965
28	.0126	66.660	71.560	W28S2.0FXTC1A	.0166	.566	W28D2.0FXTC1A	.0206	.675	W28T2.0FXXTTC1A	.0246	.807
29	.0113	82.880	88.970	W29S2.0FXTC1A	.0153	.464	W29D2.0FXTC1A	.0193	.566	W29T2.0FXXTTC1A	.0233	.690
30	.0100	105.800	113.600	W30S2.0FXTC1A	.0140	.373	W30D2.0FXTC1A	.0180	.467	W30T2.0FXXTTC1A	.0220	.584
31	.0089	133.900	143.800	W31S2.0FXTC1A	.0129	.304	W31D2.0FXTC1A	.0169	.391	W31T2.0FXXTTC1A	.0209	.502
32	.0080	166.200	178.400	W32S2.0FXTC1A	.0120	.252	W32D2.0FXTC1A	.0160	.334	W32T2.0FXXTTC1A	.0200	.440
33	.0071	211.700	228.200	W33S2.0FXTC1A	.0111	.206	W33D2.0FXTC1A	.0151	.283	W33T2.0FXXTTC1A	.0191	.383
34	.0063	269.800	289.600	W34S2.0FXTC1A	.0103	.169	W34D2.0FXTC1A	.0143	.241	W34T2.0FXXTTC1A	.0183	.336
35	.0056	342.800	368.100	W35S2.0FXTC1A	.0096	.139	W35D2.0FXTC1A	.0136	.207	W35T2.0FXXTTC1A	.0176	.299
36	.0050	431.900	463.700	W36S2.0FXTC1A	.0090	.117	W36D2.0FXTC1A	.0130	.181	W36T2.0FXXTTC1A	.0170	.269
37	.0045	535.700	575.100	W37S2.0FXTC1A	.0085	.099	W37D2.0FXTC1A	.0125	.161	W37T2.0FXXTTC1A	.0165	.246
38	.0040	681.900	732.000	W38S2.0FXTC1A	.0080	.084	W38D2.0FXTC1A	.0120	.142	W38T2.0FXXTTC1A	.0160	.224
39	.0035	897.100	963.100	W39S2.0FXTC1A	.0075	.069	W39D2.0FXTC1A	.0115	.125	W39T2.0FXXTTC1A	.0155	.204
40	.0031	1152.000	1237.000	W40S2.0FXTC1A	.0071	.059	W40D2.0FXTC1A	.0111	.112	W40T2.0FXXTTC1A	.0151	.189

- NOTES: 1. Double and triple insulated conductors are included in UL approved Electrical Insulation System designated as NE-F1.  
 2. Conductor DC resistance is provided as maximum Ohms/1000 Ft @ 20°C.  
 3. Our standard colors for these products include: clear, white, black, red, green, yellow, blue, brown, orange, gray and violet. Most are RoHS Compliant; please contact our design team to discuss your specific requirement.

Use of NEWind® Specialty Winding insulated conductors result in much smaller transformers due to decrease in number of winding wires required and removal of barrier tape and interleaved insulation tapes. Available in single layer of insulation, Supplementary (double layer) and Reinforced (triple layer) styles.

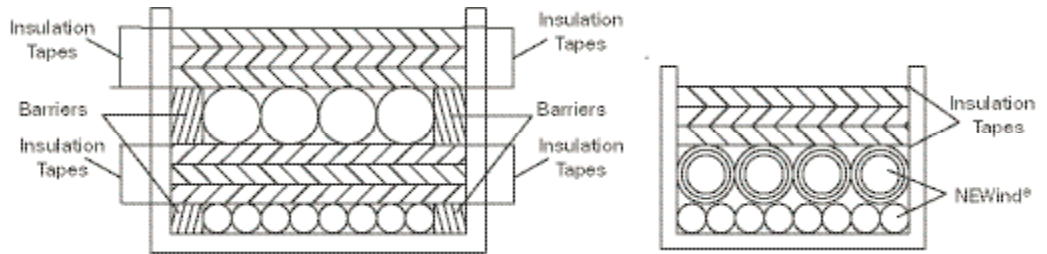

**USE:** Telecommunication devices, laptop computers, digital cameras, games and other electronic devices such as electronic transformers, power adapters, switching mode power supply modules, battery chargers for mobile phones, motors and coils.

All measurements are in inches unless otherwise stated.

# NEWind® - Solid/ETFE Insulated Conductors

**DESCRIPTION:** Specialty winding wire for transformers and coils that doesn't require interleaving insulation between layers.

**Conductor Material:** Solid Copper  
**Insulation Thickness:** .0015" min per Layer  
**Voltage Rating:** Single Layer 600Vpk  
 Double & Triple Layer 1000 Vpk  
**Temperature Rating:** UL/VDE Class F 155° C  
**Dielectric Strength:** 1800 V/mil nominal

**Single Layer:** UL 60950 Annex U      UL File E205791  
**Double Layer:** UL 60950 Annex U      UL File E205791  
 IEC 60950 Annex U      VDE Reg. No. 135444  
**Triple Layer:** UL 60950 Annex U      UL File E205791  
 IEC 60950 Annex U      VDE Reg. No. 135445

CONDUCTOR		DC RESISTANCE		SINGLE INSULATION			DOUBLE INSULATION			TRIPLE INSULATION		
AWG	O.D.	Bare Copper	Tinned Copper	PART NUMBER	O.D.	LBS/1000 FT	PART NUMBER	O.D.	LBS/1000 FT	PART NUMBER	O.D.	LBS/1000 FT
18	.0403	6.516	6.995	W18S1.5EXTC1A	.0433	5.064	W18D1.5EXXTC1A	.0463	5.217	W18T1.5EXXTC1A	.0493	5.383
19	.0359	8.211	8.815	W19S1.5EXTC1A	.0389	4.023	W19D1.5EXXTC1A	.0419	4.171	W19T1.5EXXTC1A	.0449	4.322
20	.0320	10.330	11.090	W20S1.5EXTC1A	.0350	3.216	W20D1.5EXXTC1A	.0380	3.343	W20T1.5EXXTC1A	.0410	3.480
21	.0285	13.030	13.990	W21S1.5EXTC1A	.0315	2.563	W21D1.5EXXTC1A	.0345	2.677	W21T1.5EXXTC1A	.0375	2.802
22	.0253	16.530	17.750	W22S1.5EXTC1A	.0283	2.031	W22D1.5EXXTC1A	.0313	2.134	W22T1.5EXXTC1A	.0343	2.248
23	.0226	20.720	22.240	W23S1.5EXTC1A	.0256	1.630	W23D1.5EXXTC1A	.0286	1.724	W23T1.5EXXTC1A	.0316	1.828
24	.0201	26.190	28.120	W24S1.5EXTC1A	.0231	1.298	W24D1.5EXXTC1A	.0261	1.383	W24T1.5EXXTC1A	.0291	1.479
25	.0179	33.030	35.460	W25S1.5EXTC1A	.0209	1.037	W25D1.5EXXTC1A	.0239	1.115	W25T1.5EXXTC1A	.0269	1.203
26	.0159	41.860	44.940	W26S1.5EXTC1A	.0189	.826	W26D1.5EXXTC1A	.0219	.897	W26T1.5EXXTC1A	.0249	.978
27	.0142	52.480	56.340	W27S1.5EXTC1A	.0172	.665	W27D1.5EXXTC1A	.0202	.730	W27T1.5EXXTC1A	.0232	.805
28	.0126	66.660	71.560	W28S1.5EXTC1A	.0156	.530	W28D1.5EXXTC1A	.0186	.589	W28T1.5EXXTC1A	.0216	.659
29	.0113	82.880	88.970	W29S1.5EXTC1A	.0143	.431	W29D1.5EXXTC1A	.0173	.486	W29T1.5EXXTC1A	.0203	.551
30	.0100	105.800	113.600	W30S1.5EXTC1A	.0130	.343	W30D1.5EXXTC1A	.0160	.393	W30T1.5EXXTC1A	.0190	.454
31	.0089	133.900	143.800	W31S1.5EXTC1A	.0119	.276	W31D1.5EXXTC1A	.0149	.322	W31T1.5EXXTC1A	.0179	.379
32	.0080	166.200	178.400	W32S1.5EXTC1A	.0110	.227	W32D1.5EXXTC1A	.0140	.270	W32T1.5EXXTC1A	.0170	.324
33	.0071	211.700	228.200	W33S1.5EXTC1A	.0101	.182	W33D1.5EXXTC1A	.0131	.223	W33T1.5EXXTC1A	.0161	.273
34	.0063	269.800	289.600	W34S1.5EXTC1A	.0093	.147	W34D1.5EXXTC1A	.0123	.185	W34T1.5EXXTC1A	.0153	.233
35	.0056	342.800	368.100	W35S1.5EXTC1A	.0086	.120	W35D1.5EXXTC1A	.0116	.155	W35T1.5EXXTC1A	.0146	.200
36	.0050	431.900	463.700	W36S1.5EXTC1A	.0080	.098	W36D1.5EXXTC1A	.0110	.131	W36T1.5EXXTC1A	.0140	.175
37	.0045	535.700	575.100	W37S1.5EXTC1A	.0075	.082	W37D1.5EXXTC1A	.0105	.113	W37T1.5EXXTC1A	.0135	.155
38	.0040	681.900	732.000	W38S1.5EXTC1A	.0070	.068	W38D1.5EXXTC1A	.0100	.097	W38T1.5EXXTC1A	.0130	.137
39	.0035	897.100	963.100	W39S1.5EXTC1A	.0065	.054	W39D1.5EXXTC1A	.0095	.082	W39T1.5EXXTC1A	.0125	.120
40	.0031	1152.000	1237.000	W40S1.5EXTC1A	.0061	.045	W40D1.5EXXTC1A	.0091	.071	W40T1.5EXXTC1A	.0121	.108

- NOTES: 1. Double and triple insulated conductors are included in UL approved Electrical Insulation System designated as NE-F1.  
 2. Conductor DC resistance is provided as maximum Ohms/1000 Ft @ 20°C.  
 3. Our standard colors for these products include: clear, white, black, red, green, yellow, blue, brown, orange, gray and violet. Most are RoHS Compliant; please contact our design team to discuss your specific requirement.

Use of NEWind® Specialty Winding insulated conductors result in much smaller transformers due to decrease in number of winding wires required and removal of barrier tape and interleaved insulation tapes. Available in single layer of insulation, Supplementary (double layer) and Reinforced (triple layer) styles.

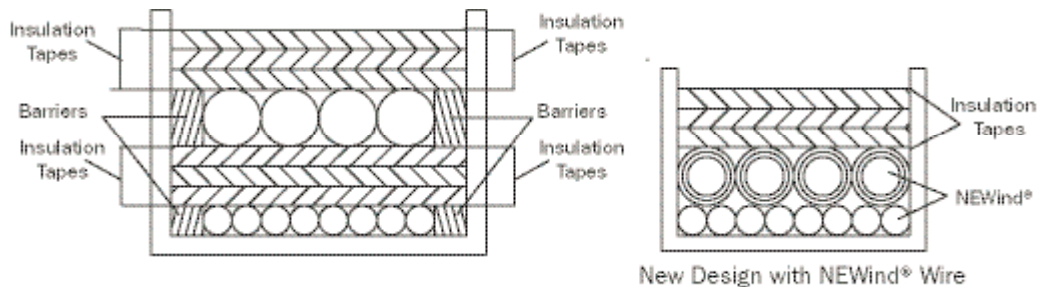

**USE:** Telecommunication devices, laptop computers, digital cameras, games and other electronic devices such as electronic transformers, power adapters, switching mode power supply modules, battery chargers for mobile phones, motors and coils.

All measurements are in inches unless otherwise stated.

www.newenglandwire.com  
 Tel: 603.838.6624

# NE-F1 Class F (155 ° C) Electrical Insulation System

**TECHNICAL INFORMATION** Electrical insulation systems are invaluable to coil and transformer designers as they eliminate the need for long term component testing. Combining the regulatory approvals of NE-F1 with the capabilities and experience of New England Wire Technologies at producing high performance winding wire products allows us to provide unique solutions to meet design challenges associated with today’s winding needs.

NE-F1 Class F (155°C) Electrical Insulation System was developed as a solution to cost, size and time saving issues. Extensive research and component testing allow us to provide a complete range of materials that are ideal for transformer, motor and coil designs leading to higher efficiency, smaller, lower cost devices that can be brought to market without longterm testing delays.

NE-F1 features NEWind™ Specialty Winding Wires which are designed to eliminate the need for separate ground, interwinding and turn insulation. This results in a smaller device that performs equivalent to, if not better than, the bulky and costlier larger devices.

NE-F1 also features a wide variety of bobbin materials, tapes, sleeving, potting compounds and varnishes. This diverse selection of material ensures that NE-F1 will be suitable for the need for multiple Electrical Insulation

INSULATION SYSTEM - MAJOR COMPONENTS	
<b>Magnet Wire (Winding Wire)</b>	
Category	Components
Polyester	MW30, MW35, MW73, MW74, MW76
Polyester (Solderable)	MW77, MW78
Polyurethane (Solderable)	MW79, MW80, MW82, MW83
NEWind® Winding Wire	ETFE, FEP, PFA
<b>Ground and Interwinding Insulation</b>	
Supplier	Components
E.J. DuPont	Kapton HN
	Nomex 410, 414, 416, 418
	PTFE
	Rymite 530, FR530, FR530L, FR943
Sumitomo Bakelite	Zente 6130
	E4008
-	PM-9630
-	PET FILM
<b>Varnishes</b>	
Supplier	Components
John C. Dolph	AC-43
	BC-346A, BC-346B, BC-346-4N, BC-346F
	BC350
	BC365
	CC-1105
Ripley Resin Engineering	488-2
Viking Products	V1380FC
	V1630FS

**PRODUCT DETAILS** UL recognized for Class F (155° C) applications:  
 OBUS2 File E231977  
 Component IEC 60085  
 CAN/CSA C22.2 No. 0-M91, Appendix B

Approved for use in the construction of transformers, motors and coils. Provides a large selection of major and minor component materials to support any application.





## BRAIDS, CABLES, AND STRANDS

High-quality custom braids, cables and strands call for a high degree of technical expertise, precision manufacturing equipment, and short lead times—all core strengths of New England Wire Technologies.

We've earned a solid reputation for our ability to turnaround both large and small orders in record time. And many of our braids, cables and strands are in stock and ready to ship.

As a leading producer of high-quality braided products, New England Wire Technologies designs and manufactures flat-wire braiding, braid-reinforced tubing, scope braids and insulated braids. Our products are used for applications such as ground strap, motor brush leads, circuit breaker shunts, flexible bus bar, RFI/EMI shielding and shielding for mechanical protection of single or multi-conductor cables. We also create flexible cables and strands for use as flexible conductors in custom single and multiconductor insulated cables.

Be sure to check with our sales department for information on custom conductors designed to meet your specific requirement.



## BRAIDS, CABLES, AND STRANDS

As a leading supplier of high quality braided wire products, New England Wire Technologies designs and manufactures flat-wire braiding, braid-reinforced tubing, stainless steel scope braids and insulated braids. Our high quality custom braids, cables and strands require a great deal of technical expertise, precision manufacturing and short delivery intervals—all core strengths of New England Wire.

Braids Intro . . . . .	155	Tinned Copper Oval Shielding . . . . .	162
Standard Braided Copper Cables . . . . .	156	Stainless Steel Shielding . . . . .	162
Extra wide Braided Copper Cables . . . . .	157	Cross Reference Guide . . . . .	163
Extra Flexible Round Copper Cables . . . . .	158	PVC Insulated Ground Strap . . . . .	165
Tinned Copper Braids (Flat) . . . . .	159	Cables & Strands Intro. . . . .	166
Nickel-Plated Copper Shielding Braids . . . . .	159	Extra Flexible Ropelay Strands . . . . .	167
Tinned Copper Shielding Braids (Tubular). . . . .	160	Standard Concentric & Unilay . . . . .	169
Silver-Plated Copper Shielding . . . . .	161		

# BRAIDS

New England Wire Technologies is well known as a manufacturer of high-quality braided wire products. We produce braids for diverse applications such as ground strap, motor brush leads, circuit breaker shunts and for mechanical and electrical protection of single or multiconductor cables.

- INSULATED BRAID** Flat and round braids with extruded insulations for use as ground straps and flat power leads. Typical insulation materials include: FEP, PFA, PVC, ETFE, TPE, Polyester, Polyethylene, Polypropylene, Polyurethane, Silicone Rubber.
- FLAT WIRE BRAIDING** For custom low-loss coax, miniature coax and braid-reinforced tubing.
- BRAID REINFORCED TUBING** Thin-wall extrusion and fine wire braiding for high quality braid reinforced tubing such as catheters and working channels.
- SCOPE BRAIDS** High quality stainless steel braids in various tempers for use as reinforcement of medical imaging products such as endoscopes.
- SINGLE THICKNESS BRAIDS** Non-tubular braids that are half the thickness of standard flat braids. Used primarily as static drain wires in bags for filtration systems and other applications requiring flat conductors of minimum thickness.
- BRAID-REINFORCED CAPILLARY TUBING** Single or multiple copper, copper alloy or stainless steel reinforcing braids over capillary tubing. Used in fluid or gas-actuated pressure and temperature switches and gauges. Capillary tubing with overall extrusion of plastics such as PVC or polypropylene also available.
- MONOFILAMENT BRAIDS** Plastic monofilament braids used most often to produce low-capacitance, high-end audio cables and for mechanical protection of multiconductor cables in lieu of an extruded jacket.
- TOLL BRAIDING** Overbraiding customer supplied core with copper, stainless steel, copper alloys or various textiles.

PLEASE NOTE: *Due to the inherent properties of braids, dimensions may vary from those listed. New England Wire Technologies manufactures to width specification therefore thickness measurements are given for reference only. If your application requires a specific thickness, please consult with our design team for an appropriate construction.*

# Standard Braided Copper Cables



**DESCRIPTION:** Standard braided copper cables are manufactured of bare or tinned copper. Part numbers listed in this section are tinned copper, however are also available in silver-plated and nickel-plated copper.

**USE:** Bonds, grounds, leads and flexible connectors. Please contact our design team for your specific application and desired materials.

New England Part Number	CROSS SECTIONAL AREA			AWG of Wire	Number of Wires	Construction	Nominal Width	Nominal Thickness*	LBS/1000 FT
	Equivalent Size	Circular Mil Area	SQ MM						
NE4136TR	30 AWG	100	.051	36	4	4-1-36	.019 Round		.333
NE6240TR	30 AWG	113	.057	40	12	6-2-36	.018 Round		.384
NE12242TR	29 AWG	150	.076	42	24	12-2-42	.023 Round		.499
NE6136TR	29 AWG	150	.076	36	6	6-1-36	.022 Round		.499
NE8240TR	29 AWG	154	.078	40	16	8-2-40	.018 Round		.512
NE8136TR	27 AWG	200	.101	36	8	8-1-36	.021 Round		.666
NE12240TR	27 AWG	231	.117	40	24	12-2-40	.025 Round		.768
NE12136TR	26 AWG	300	.152	36	12	12-1-36	.028 Round		.999
NE16240TR	26 AWG	308	.156	40	32	16-2-40	.026 Round		1.024
NE8134TR	25 AWG	318	.161	34	8	8-1-34	.030 Round		1.06
NE16136TR	24 AWG	400	.200	36	16	16-1-36	.029 Round		1.33
NE16340TR	24 AWG	461	.230	40	48	16-3-40	.035 Round		1.40
NE24136TR	23 AWG	600	.300	36	24	24-1-36	.047	.020	2.00
NE12236TR	23 AWG	600	.300	36	24	12-2-36	.047	.025	2.00
NE8336TRT	23 AWG	600	.300	36	24	8-3-36	.038 Round		2.00
NE66-40T	22 AWG	634	.320	40	66	14-4-40 & 2-5-40	.041 Round		1.92
NE16134TR	22 AWG	635	.320	34	16	16-1-34	.038 Round		2.11
NE16236T	21 AWG	800	.410	36	32	16-2-36	.063	.025	2.42
NE16640T	21 AWG	923	.470	40	96	16-6-40	.063	.031	3.07
NE12940TR	20 AWG	1038	.530	40	108	12-9-40	.065 Round		3.46
NE16336T	20 AWG	1200	.610	36	48	16-3-36	.094	.020	4.00
NE24236T	20 AWG	1200	.610	36	48	24-2-36	.094	.025	4.00
NE16436T	18 AWG	1600	.810	36	64	16-4-36	.094	.025	5.32
NE24336T	18 AWG	1800	.910	36	72	24-3-36	.109	.025	5.45
NE16536T	18 AWG	2000	1.01	36	80	16-5-36	.125	.025	6.66
NE124244TR	17 AWG	2016	1.02	44	504	12-42-44	.068 Round		6.29
NE24436T	17 AWG	2400	1.22	36	96	24-4-36	.156	.031	7.99
NE24536T	16 AWG	3000	1.52	36	120	24-5-36	.188	.020	9.99
NE24736T	14 AWG	4200	2.13	36	168	24-7-36	.219	.031	13.98
NE241036T	13 AWG	6000	3.04	36	240	24-10-36	.250	.040	19.98
NE48636T	12 AWG	7200	3.65	36	288	48-6-36	.375	.030	23.97
NE241336T	12 AWG	7800	3.95	36	312	24-13-36	.281	.047	25.97
NE48836T	11 AWG	9600	4.86	36	384	48-8-36	.500	.030	31.96
NE241636T	11 AWG	9600	4.86	36	384	24-16-36	.375	.063	31.96
NE24430T	11 AWG	9600	4.86	30	96	24-4-30	.313	.050	31.96
NE24530T	10 AWG	12000	6.08	30	120	24-5-30	.375	.050	39.96
NE481136T	9 AWG	13200	6.69	36	528	48-11-36	.625	.040	43.95
NE24730T	8 AWG	16800	8.51	30	168	24-7-30	.438	.063	55.94
NE481536T	8 AWG	18000	9.12	36	720	48-15-36	.630	.040	61.15
NE832-36T-1	7 AWG	20800	10.50	36	832	(32-17-36)&(16-18-36)	1.000	.045	69.26
NE481936T	7 AWG	22800	11.60	36	912	48-19-36	.813	.050	75.90
NE244036T	7 AWG	24000	12.20	36	960	24-40-36	.530	.094	75.16
NE241030T	7 AWG	24000	12.20	30	240	24-10-30	.500	.094	81.51
NE482236T	6 AWG	26400	13.40	36	1056	48-22-36	.880	.040	87.90
NE241530T	5 AWG	36000	18.20	30	360	24-15-30	.630	.094	127.80

\* Material is manufactured to width specification; thickness dimensions are given as reference only and may vary slightly due to the manufacturing process inherent with braiding. Please contact our design team for your specific requirements.

All measurements are in inches unless otherwise stated.



## Standard Braided Copper Cables, continued

New England Part Number	CROSS SECTIONAL AREA			AWG of Wire	Number of Wires	Construction	Nominal Width	Nominal Thickness*	LBS/1000 FT
	Equivalent Size	Circular Mil Area	SQ MM						
NE488640T	5 AWG	39670	20.10	40	4128	48-86-40	.810	.125	134.7
NE246736T	4 AWG	40200	20.40	36	1608	24-67-36	.750	.094	142.7
NE484036T	4 AWG	48000	24.30	36	1920	48-40-36	1.00	.094	163.0
NE242030T	4 AWG	48000	24.30	30	480	24-20-30	.750	.125	170.4
NE242730T	3 AWG	64800	32.80	30	648	24-27-30	.940	.125	230.1
NE486036T	2 AWG	72000	36.50	36	2880	48-60-36	1.250	.094	255.6
NE243230T	2 AWG	76800	38.90	30	768	24-32-30	1.000	.125	248.0
NE488436T	1 AWG	100800	51.10	36	4032	48-84-36	1.630	.125	357.9
NE244430T	1/0 AWG	105600	53.50	30	1056	24-44-30	1.250	.125	374.9
NE2242730T	1/0 AWG	129600	65.70	30	1296	2(24-27-30)	1.130	.250	460.2
NE2243230T	2/0 AWG	153600	77.80	30	1536	2(24-32-30)	1.250	.250	545.5
NE2243530T	3/0 AWG	168000	85.10	30	1680	2(24-35-30)	1.250	.250	596.5
NE3243230T	4/0 AWG	230400	116.70	30	2304	3(24-32-30)	1.250	.375	818.1
NE4243230T	300 MCM	307200	155.70	30	3072	4(24-32-30)	1.375	.500	1091.0

\* Material is manufactured to width specification; thickness dimensions are given as reference only and may vary slightly due to the manufacturing process inherent with braiding. Please contact our design team for your specific requirements.

All measurements are in inches unless otherwise stated.

## Extra Wide Braided Copper Cables



Standard braided copper cables are manufactured of bare or tinned copper. Part numbers listed in this section are tinned copper, however are also available in silver-plated or nickel-plated copper; please contact our design team for your specific application and desired materials.

New England Part Number	CROSS SECTIONAL AREA			AWG of Wire	Number of Wires	Construction	Nominal Width	Nominal Thickness*	LBS/1000 FT
	Equivalent Size	Circular Mil Area	SQ MM						
NE48530T	7 AWG	24000	12.2	30	240	48-5-30	.75	.094	79.9
NE48730T	5 AWG	33600	17.0	30	336	48-7-30	1.38	.094	111.9
NE48830T	5 AWG	38400	19.5	30	384	48-8-30	1.00	.094	133.7
NE481030T	4 AWG	48000	24.3	30	480	48-10-30	1.25	.125	167.1
NE481430T	2 AWG	67200	34.1	30	672	48-14-30	1.38	.125	238.6
NE481630T	2 AWG	76800	38.7	30	768	48-16-30	1.50	.125	272.7
NE481830T	1 AWG	86400	43.8	30	864	48-18-30	1.63	.125	306.8
NE482230T	1/0 AWG	105600	53.5	30	1056	48-22-30	1.75	.125	374.9
NE482830T	2/0 AWG	134400	67.1	30	1344	48-28-30	2.00	.125	477.2
NE483230T	2/0 AWG	153600	77.8	30	1536	48-32-30	2.00	.120	497.0
NE483530T	3/0 AWG	168000	85.1	30	1680	48-35-30	2.25	.150	596.5
NE484430T	4/0 AWG	211200	107.0	30	2112	48-44-30	2.38	.156	749.9
NE485230T	250 MCM	249600	126.5	30	2496	48-52-30	2.50	.156	886.2
NE2483230T	300 MCM	307200	155.7	30	3072	2(48-32-30)	2.13	.313	1091.0
NE3483530T	500 MCM	504000	255.4	30	5040	3(48-35-30)	2.25	.400	1790.0

\* Material is manufactured to width specification; thickness dimensions are given as reference only and may vary slightly due to the manufacturing process inherent with braiding. Please contact our design team for your specific requirements.

All measurements are in inches unless otherwise stated.

[www.newenglandwire.com](http://www.newenglandwire.com)

Tel: 603.838.6624

# Extra Flexible (Round) Braided Copper Cables



**USE: Flexible bus connectors, motor brush leads, circuit breaker shunts and other interconnect applications. Part numbers listed are of bare copper wire but are also available in tin-plated, silver-plated or nickel-plated copper. Please contact our design team for your specific application.**

New England Part Number	CROSS SECTIONAL AREA			AWG of Wire	Number of Wires	Construction	Nominal OD	LBS/1000 FT
	Equivalent AWG Size	Circular Mil Area	SQ MM					
NE18-44BR	32	72	.036	44	18	6-2 & 2-3-44	.011	.240
NE33-44BR	29	132	.067	44	33	7-4 & 1-5-44	.016	.440
NE8240BR	29	154	.078	40	16	8-2-40	.018	.512
NE51-44BR	27	204	.103	44	51	5-6 & 3-7-44	.022	.617
NE16240BR	26	308	.156	40	32	16-2-40	.026	1.024
NE81044BR	25	320	.162	44	80	8-10-44	.025	1.087
NE16544BR	25	320	.162	44	80	16-5-44	.025	1.065
NE71544BR	24	420	.210	44	105	7-15-44	.028	1.296
NE16340BR	24	461	.230	40	48	16-3-40	.035	1.536
NE8740BR	23	538	.270	40	56	8-7-40	.032	1.678
NE62544BR	23	600	.300	44	150	6-25-44	.034	2.038
NE150-44BR	23	600	.300	44	150	2-37 & 2-38-44	.035	2.038
NE16440BR	23	615	.310	40	64	16-4-40	.038	2.048
NE66-40BR	22	634	.320	40	66	14-4 & 2-5-40	.041	2.112
NE71340BR	21	875	.440	40	91	7-13-40	.045	2.970
NE71540BR	20	1009	.510	40	105	7-15-40	.050	3.299
NE105-40BR	20	1009	.510	40	105	16-3-40 over 57/40 core	.041	3.180
NE74044BR	20	1120	.570	44	280	7-40-44	.051	3.804
NE83544BR	20	1120	.570	44	280	8-35-44	.050	3.804
NE84044BR	19	1280	.650	44	320	8-40-44	.055	4.347
NE162044BR	19	1280	.650	44	320	16-20-44	.055	4.347
NE140-40BR	19	1345	.680	40	140	16-5-40 over 60/40 core	.046	4.287
NE72340BR	19	1547	.780	40	161	7-23-40	.056	5.257
NE424-44BR	18	1696	.860	44	424	16-23-44 over 56/44 core	.047	5.690
NE189-40BR	18	1816	.920	40	189	24-4-40 over 93/40 core	.049	5.718
NE161340BR	18	1999	1.010	40	208	16-13-40	.067	6.477
NE124244BR	17	2016	1.020	44	504	12-42-44	.068	6.285
NE242144BR	17	2016	1.020	44	504	24-21-44	.075	6.847
NE504-44BR	17	2016	1.020	44	504	16-28-44 over 56-44 core	.060	6.086
NE73340BR	17	2220	1.120	40	231	7-33-40	.072	7.795
NE328-40BR	15	3152	1.600	40	328	16-10-40 over 7x24/40 core	.082	10.304
NE805-44BR	15	3220	1.630	44	805	16-47-44 over 53/44 core	.083	10.910
NE126844BR	15	3264	1.650	44	816	12-68-44	.083	11.090
NE376-40BR	15	3613	1.830	40	376	16-13-40 over 7x24/40 core	.080	11.738
NE438-40BR	14	4209	2.130	40	438	24-12-40 over 3x50/40 core	.100	13.937
NE242240BR	14	5074	2.570	40	528	24-22-40	.095	17.230
NE600-40BR	13	5766	2.920	40	600	16-34-40 over 56/40 core	.106	19.422
NE2122740BR	13	6227	3.160	40	648	2(12-27-40)	.125	23.100

*All measurements are in inches unless otherwise stated.*



**NEW ENGLAND WIRE TECHNOLOGIES**  
*Innovate. Create. Accelerate.*

## Tinned Copper Wire Braids (Flat)



Federal Specification QQ-B-575C, dated September 22, 1993 was canceled on November 20, 2000 and replaced by Commercial Item Description (CID) A-A-59569.

Part numbers listed are tinned copper braids. All items also available in silver-plated copper. Please contact our design team for your specific application.

New England Part Number	Specification Part Number	Width x Thickness*	AWG of Wire	Number of Wires	Equivalent AWG	Circular Mil Area	Feet/LB	LBS/1000 FT
NEQF24136T	AA59569F36T0031	.046 x .020	36	24	22	500.0	600	2.0
NEQF24236T	AA59569F36T0062	.093 x .031	36	48	19	250.0	1200	4.0
NEQF24336T	AA59569F36T0078	.125 x .020	36	72	18	166.0	1800	6.0
NEQF24436T	AA59569F36T0109	.156 x .031	36	96	16	125.0	1400	8.0
NEQF24536T	AA59569F36T0125	.187 x .020	36	120	15	100.0	3000	10.0
NEQF241036T	AA59569F36T0156	.250 x .046	36	40	12	50.0	6000	20.0
NEQF24736T	AA59569F36T0171	.250 x .030	36	168	14	71.5	4200	14.0
NEQF241336T	AA59569F36T0203	.281 x .046	36	312	11	38.5	7800	26.0
NEQF48836T	AA59569F36T0375	.625 x .046	36	384	10	31.2	9600	32.0
NEQF241030T	AA59569F30T0437	.500 x .093	30	240	6	11.9	24000	83.5
NEQF481136T	AA59569F36T0500	.625 x .046	36	528	9	22.7	13200	44.0
NEQF241530T	AA59569F30T0500	.625 x .093	30	360	6	8.0	36000	125.3
NEQF481836T	AA59569F36T0781	.750 x .040	36	864	7	13.9	21600	71.9
NEQF48730T	AA59569F30T1875	1.375 x .050	30	336	5	8.9	33600	111.9
NEQF481130T	AA59569F30T1375	1.500 x .060	30	528	3	5.5	52800	183.3

## Nickel-Plated Copper Wire Shielding Braids (Tubular)

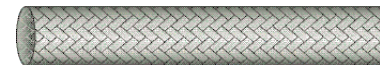

Individual wires have 50 microinches of Nickel Plating over copper. Recommended for high temperature applications up to 400° C or if special corrosion resistance is required. Please contact our design team for your specific requirements.

New England Part Number	Nominal Inside Diameter	AWG of Wire	Number of Wires	Construction	Equivalent AWG	Circular Mil Area	Feet/LB	LBS/1000 FT
NEQ24236NP	.063	36	48	24-2-36	19	1200	250.0	4.00
NEQ24436NP	.109	36	96	24-4-36	16	2400	125.1	7.99
NEQ24536NP	.125	36	120	24-5-36	15	3000	100.1	9.99
NEQ24836NP	.875	36	192	24-8-36	14	4800	62.5	15.98
NEQ24834NP	.250	34	192	24-8-34	11	7632	39.4	25.37
NEQ48636NP	.313	36	288	48-6-36	12	7200	41.7	23.97
NEQ48836NP	.375	36	384	48-8-36	10	9600	31.3	31.96
NEQ48634NP	.438	34	288	48-6-34	10	11434	26.3	38.06
NEQ481136NP	.500	36	528	48-11-36	9	13200	22.8	43.95
NEQ481536NP	.625	36	720	48-15-36	8	18000	16.8	59.40
NEQ481836NP	.781	36	864	48-18-36	7	21600	13.9	71.92
NEQ481032NP	.875	32	480	48-10-32	6	30720	9.4	106.90
NEQ48830NP	1.000	30	384	48-8-30	5	38400	7.4	133.70
NEQ481130NP	1.375	30	528	48-11-30	3	52800	4.4	183.80
NEQ481230NP	1.500	30	576	48-12-30	3	57600	5.0	200.50
NEQ481430NP	1.875	30	672	48-14-30	2	67200	4.3	233.90
NEQ481630NP	2.250	30	768	48-16-30	1	76800	3.9	255.00

\* Material is manufactured to width specification; thickness dimensions are given as reference only and may vary slightly due to the manufacturing process inherent with braiding. Please contact our design team for your specific requirements.

All measurements are in inches unless otherwise stated.

[www.newenglandwire.com](http://www.newenglandwire.com)

Tel: 603.838.6624

# Tinned Copper Wire Shielding Braid (Tubular)

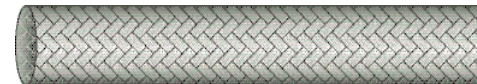

**DESCRIPTION:** Federal Specification QQ-B-575C, dated September 22, 1993 was cancelled on November 20, 2000 and replaced by Commercial Item Description (CID) A-A-59569. This CID covers tin- or silver-plated copper wire braids supplied in tubular or flat form intended for use as shielding over electrical conductors, controller contacts and grounding bonds.

**USE:** Motor brush leads, circuit breaker shunts & other inter-connect applications. Part numbers listed are of tinned copper wire but available in bare copper as well; please contact our design team for your specific requirements.

New England Part Number	Specification Part Number	Nominal Inside Diameter	AWG of Wire	Number of Wires	Equivalent AWG	Circular Mil Area	Feet/LB	LBS/1000 FT
NEQ24136T	AA59569R36T0031	.031	36	24	22	600	500.5	2.0
NEQ24236T	AA59569R36T0062	.062	36	48	19	1200	263.4	3.9
NEQ16234T	AA59569R34T0062	.062	34	32	19	1351	236.5	4.3
NEQ16132T	AA59569R32T0062	.062	32	16	20	1011	293.3	3.4
NEQ24336T	AA59569R36T0078	.078	36	72	18	1800	166.9	5.9
NEQ24436T	AA59569R36T0109	.109	36	96	16	2400	126.6	7.9
NEQ16434T	AA59569R34T0109	.109	34	64	16	2544	118.3	8.5
NEQ16232T	AA59569R32T0109	.109	32	32	17	2023	146.6	6.8
NEQ24536T	AA59569R36T0125	.125	36	120	15	3000	100.1	9.9
NEQ24334T	AA59569R34T0125	.125	34	72	16	2862	105.1	9.5
NEQ24232T	AA59569R32T0125	.125	32	48	15	3034	97.8	10.2
NEQ241036T	AA59569R36T0156	.156	36	240	12	6000	50.1	20.0
NEQ24736T	AA59569R36T0171	.171	36	168	14	4200	71.5	14.0
NEQ24534T	AA59569R34T0171	.171	34	120	13	4770	63.1	15.9
NEQ24332T	AA59569R32T0171	.171	32	72	14	4551	65.2	15.3
NEQ241336T	AA59569R36T0203	.203	36	312	11	7800	38.5	26.0
NEQ24834T	AA59569R34T0203	.203	34	192	11	7632	39.4	25.4
NEQ24532T	AA59569R32T0203	.203	32	120	11	7585	39.1	25.6
NEQ241636T	AA59569R36T0250	.250	36	384	10	9600	31.3	32.0
NEQ24530T	AA59569R30T0281	.281	30	120	9	12000	25.0	40.0
NEQ48836T	AA59569R36T0375	.375	36	384	10	9600	31.3	32.0
NEQ48534T	AA59569R34T0375	.375	34	240	10	9540	31.5	31.7
NEQ48332T	AA59569R32T0375	.375	32	144	11	9102	32.6	30.7
NEQ24730T	AA59569R30T0375	.375	30	168	8	16800	17.1	58.5
NEQ241030T	AA59569R30T0437	.437	30	240	6	24000	12.0	83.5
NEQ481136T	AA59569R36T0500	.500	36	528	9	13200	22.8	44.0
NEQ48734T	AA59569R34T0500	.500	34	336	9	13356	22.5	44.4
NEQ241530T	AA59569R30T0500	.500	30	360	6	36000	8.0	125.3
NEQ481030T	AA59569R30T0562	.562	30	480	3	48000	5.9	170.4
NEQ481630T	AA59569R30T0656	.656	30	768	1	76800	3.7	267.3
NEQ481836T	AA59569R36T0781	.781	36	864	7	21600	13.9	71.9
NEQ481134T	AA59569R34T0781	.781	34	528	7	20956	14.3	69.8
NEQ48732T	AA59569R32T0781	.781	32	336	7	21239	14.0	71.6
NEQL48730T	AA59569R30T0875	.875	30	336	5	33600	8.5	117.0
NEQL48830T	AA59569R30T1000	1.000	30	384	4	38400	7.5	133.7
NEQL48930T	AA59569R30T1125	1.125	30	432	4	43200	6.6	150.4
NEQL481030T*		1.250	30	480	4	48000	5.9	170.4
NEQL481130T	AA59569R30T1375	1.375	30	528	3	52800	5.4	183.8
NEQL481230T*		1.500	30	576	2	57600	5.0	200.5
NEQL481430T*		2.000	30	672	2	67200	4.4	233.9
NEQL481630T*		2.250	30	768	2	76800	3.9	267.3

\*Manufactured to Commercial Item Description A-A-59569 standards although these extra large sizes are not listed in the specification.

All measurements are in inches unless otherwise stated.





# Silver-Plated Copper Wire Shielding Braids (Tubular)



In accordance with the specification, all items are manufactured with a minimum plating thickness of 40 microinches.

**DESCRIPTION:** Federal Specification QQ-B-575C, dated September 22, 1993 was cancelled on November 20, 2000 and replaced by Commercial Item Description (CID) A-A-59569. This CID covers tin- or silver-plated copper wire braids supplied in tubular or flat form intended for use as shielding over electrical conductors, controller contacts and grounding bonds.

**USE:** Silver plating, in lieu of tin plating, is necessary when the shielding is to be subjected to temperatures exceeding 150° C or if special corrosion resistance is required.

New England Part Number	Specification Part Number	Nominal Inside Diameter	AWG of Wire	Number of Wires	Equivalent AWG	Circular Mil Area	Feet/LB	LBS/1000 FT
NEQ24136SP	AA59569R36S0031	.031	36	24	22	600	500.5	2.0
NEQ24236SP	AA59569R36S0062	.062	36	48	19	1200	263.4	3.9
NEQ16234SP	AA59569R34S0062	.062	34	32	19	1351	236.5	4.3
NEQ16132SP	AA59569R32S0062	.062	32	16	20	1011	293.3	3.4
NEQ24336SP	AA59569R36S0078	.078	36	72	18	1800	166.9	6.0
NEQ24436SP	AA59569R36S0109	.109	36	96	16	2400	126.6	7.9
NEQ16434SP	AA59569R34S0109	.109	34	64	16	2544	118.3	8.5
NEQ16232SP	AA59569R32S0109	.109	32	32	17	2023	146.6	6.8
NEQ24536SP	AA59569R36S0125	.125	36	120	15	3000	100.1	10.0
NEQ24334SP	AA59569R34S0125	.125	34	72	16	2862	105.1	9.5
NEQ24232SP	AA59569R32S0125	.125	32	48	15	3034	97.8	10.2
NEQ241036SP	AA59569R36S0156	.156	36	240	12	6000	50.1	20.0
NEQ24736SP	AA59569R36S0171	.171	36	168	14	4200	71.5	14.0
NEQ24534SP	AA59569R34S0171	.171	34	120	13	4770	63.1	15.9
NEQ24332SP	AA59569R32S0171	.171	32	72	14	4551	65.2	15.3
NEQ241336SP	AA59569R36S0203	.203	36	312	11	7800	38.5	26.0
NEQ24834SP	AA59569R34S0203	.203	34	192	11	7632	39.4	25.4
NEQ24532SP	AA59569R32S0203	.203	32	120	11	7585	39.1	25.6
NEQ241636SP	AA59569R36S0250	.250	36	384	10	9600	31.3	32.0
NEQ24530SP	AA59569R30S0281	.281	30	120	9	12000	25.0	40.0
NEQ48836SP	AA59569R36S0375	.375	36	384	10	9600	31.3	32.0
NEQ48534SP	AA59569R34S0375	.375	34	240	10	9540	31.5	31.7
NEQ48332SP	AA59569R32S0375	.375	32	144	11	9102	32.6	30.7
NEQ24730SP	AA59569R30S0375	.375	30	168	8	16800	17.1	58.5
NEQ241030SP	AA59569R30S0437	.437	30	240	6	24000	12.0	83.5
NEQ481136SP	AA59569R36S0500	.500	36	528	9	13200	22.8	44.0
NEQ48734SP	AA59569R34S0500	.500	34	336	9	13356	22.5	44.4
NEQ241630SP	AA59569R30S0500	.500	30	360	6	36000	8.0	125.3
NEQ481030SP	AA59569R30S0562	.562	30	480	3	48000	6.6	167.0
NEQ481630SP	AA59569R30S0656	.656	30	768	1	76800	3.7	267.3
NEQ481836SP	AA59569R36S0781	.781	36	864	7	21600	13.9	71.9
NEQ481134SP	AA59569R34S0781	.781	34	528	7	20956	14.3	69.8
NEQ48732SP	AA59569R32S0781	.781	32	336	7	21239	14.0	71.6
NEQL48730SP	AA59569R30S0875	.875	30	336	5	33600	8.5	117.0
NEQL48830SP	AA59569R30S1000	1.000	30	384	4	38400	7.5	133.7
NEQL48930SP	AA59569R30S1125	1.125	30	432	4	43200	6.6	150.4
NEQL481030SP*		1.250	30	480	4	48000	5.9	167.1
NEQL481130SP	AA59569R30S1375	1.375	30	528	3	52800	5.4	183.8
NEQL481230SP*		1.500	30	476	3	57600	5.0	200.5
NEQL481430SP*		2.000	30	672	2	67200	4.4	233.9
NEQL481630SP*		2.250	30	768	1	76800	3.9	267.3

\*Manufactured to Commercial Item Description A-A-59569 standards although these extra large sizes are not listed in the specification.

All measurements are in inches unless otherwise stated.

www.newenglandwire.com

Tel: 603.838.6624

## Tinned Commercial Oval Shielding & Bonding Cables



New England Part Number	Equivalent AWG	Circular Mil Area	AWG of Wire	Number of Wires	Construction	Nominal I.D. (oval)	Approximate Feet/LB	Approximate LBS/1000 FT
NES16134T	22	635	34	16	16-1-34	.016	473.0	2.11
NES24134T	21	952	34	24	24-1-34	.031	315.3	3.17
NES16234T	19	1270	34	32	16-2-34	.063	236.5	4.23
NES16434T	16	2540	34	64	16-4-34	.109	118.2	8.46
NES24334T	16	2858	34	72	24-3-34	.125	105.1	9.52
NES24434T	15	3800	34	96	24-4-34	.188	78.8	12.69
NES24534T	13	4700	34	120	24-5-34	.172	63.0	15.86
NES24634T	13	5715	34	144	24-6-34	.188	52.5	19.03
NES24734T	12	6700	34	168	24-7-34	.250	45.0	22.20
NES24834T	12	7600	34	192	24-8-34	.313	39.4	25.37
NES48734T	9	13300	34	336	48-7-34	.500	22.5	44.40
NES48834T	9	15240	34	384	48-8-34	.625	19.7	50.75
NES481034T	8	19051	34	480	48-10-34	.688	15.8	63.43
NES481134T	7	20956	34	528	48-11-34	.781	14.3	69.78
NES481234T	7	22900	34	576	48-12-34	.875	13.1	76.12
NES48830T	5	38400	30	384	48-8-30	1.000	7.5	133.70
NES48930T	4	43200	30	432	48-9-30	1.125	6.6	150.40
NES481030T	4	48000	30	480	48-10-30	1.250	5.9	170.40
NES481130T	3	52800	30	528	48-11-30	1.375	5.4	183.80
NES481230T	3	57600	30	576	48-12-30	1.500	4.9	200.50
NES481430T	2	67200	30	672	48-14-30	2.000	4.3	233.90
NES481630T	2	76800	30	768	48-16-30	2.125	3.7	267.30

## Stainless Steel Shielding Braids (Tubular)

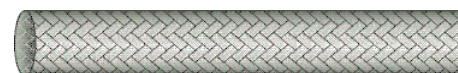

Individual wires conform to MIL-W-423, Composition 304\* (Annealed). Recommended for high temperature service up to 650°C, where mechanical strength and shield protection are important considerations. Items listed are our more popular constructions; please contact our sales team for your specific requirement.

New England Part Number	Nominal Inside Diameter	AWG of Wire	Number of Wires	Construction	Equivalent AWG	Circular Mil Area	Feet/LB	LBS/1000 FT
NES16336SS	.031	36	48	16-3-36	19	1200	285.7	3.5
NES24236SS	.063	36	48	24-2-36	19	1200	285.7	3.5
NES24336SS	.078	36	72	24-3-36	18	1800	185.0	5.4
NES24436SS	.109	36	96	24-4-36	16	2400	147.0	6.8
NES24536SS	.125	36	120	24-5-36	15	3000	117.6	8.5
NES24736SS	.172	36	168	24-7-36	14	4200	79.4	12.6
NES24836SS	.188	36	192	24-8-36	13	4800	69.4	14.4
NES24103SS	.219	36	240	24-10-36	12	6000	54.6	18.3
NES241336SS	.250	36	312	24-13-36	12	7800	42.8	23.4
NES48736SS	.375	36	336	48-7-36	11	8400	39.7	25.2
NES48836SS	.438	36	384	48-8-36	10	9600	34.8	28.8
NES48936SS	.500	36	432	48-9-36	10	10800	29.6	33.8
NES481136SS	.625	36	528	48-11-36	9	13200	24.1	41.5
NES481536SS	.750	36	720	48-15-36	8	18000	18.5	53.9
NES481836SS	.875	36	864	48-18-36	7	21600	15.4	64.7
NES48730SS	1.000	30	336	48-7-30	5	33600	9.5	105.3
NES48830SS	1.125	30	384	48-8-30	4	38400	8.3	120.3
NES481030SS	1.500	30	480	48-10-30	3	48000	6.6	150.4

\*Items listed are our more popular constructions. Also available in Composition 316.

All measurements are in inches unless otherwise stated.

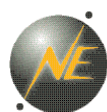

NEW ENGLAND WIRE TECHNOLOGIES  
Innovate. Create. Accelerate.

## CROSS REFERENCE GUIDE

This cross reference guide represents New England Wire products that are equivalent; please contact our sales department to confirm actual construction, put-ups and stock availability. Those products typically stocked are marked with an asterisk (\*).

### Braids

Stocked	New England Part Number	Alpha Wire Part Number	Equivalent AWG	Circular Mil Area	AWG of Wire	Number of Wires	Width	FT/LB	LBS/1000 FT
	NE8136TR	1221	27	200	36	8	.021	1492.5	.67
	NE16136TR	1222	24	400	36	16	.029 Round	769.2	1.30
*	NE24136T	1223	23	600	36	24	.047 Round	500.0	2.00
*	NE16336T	1224	19	1200	36	48	.094	250.0	4.00
*	NE24336T	1229	18	1800	36	72	.109	182.8	5.50
*	NE24536T	1230	16	3000	36	120	.188	100.0	10.00
*	NE24736T	1231	14	4200	36	168	.219	71.9	13.90
*	NE48636T	1232	12	7200	36	288	.375	41.8	23.90
*	NE48836T	1233/2	10	9600	36	384	.500	31.3	31.90
	NE481836T	1234/1235	7	21600	36	864	.750	13.9	71.92
*	NE48730T	1239	5	33600	30	336	1.375	8.9	111.90
	NE481130T	1240	3	52800	30	528	1.500	5.4	183.80
	NE482630T	1241	1/0	124800	30	1248	1.750	2.3	443.10
*	NE483230T	1242/4	2/0	153600	30	1536	2.000	2.0	497.00
	NE481130B	515533	3	52800	36	5528	1.500	5.4	183.80
	NE24536B	5115613	16	3000	36	120	.188	100.1	9.989

### Commercial Oval Shielding Cables

Stocked	New England Part Number	Alpha Wire Part Number	Equivalent AWG	Circular Mil Area	AWG of Wire	Number of Wires	Nominal OD	FT/LB	LBS/1000 FT
*	NES24534T	2138	13	4700	34	120	.172	63.0	15.86
*	NES24634T	2140	13	5715	34	144	.188	52.5	19.03
*	NES24734T	2142	12	6700	34	168	.250	45.0	22.20
*	NES24834T	2144	12	7600	34	192	.313	39.4	25.37
*	NES48734T	2146	9	13300	34	336	.500	22.5	44.40
	NES48834T	2148	9	15240	34	384	.625	19.7	50.75
	NES481034T	2150	8	19051	34	480	.688	15.8	63.43
	NES481134T	2152	7	20956	34	528	.781	14.3	69.78

## Cross Reference Guide, *continued*

### Tinned Copper Shielding Braids (Tubular) CID-A-59569

Stocked	New England Part Number	Alpha Wire Part Number	Equivalent AWG	Circular Mil Area	AWG of Wire	Number of Wires	Nominal ID	FT/LB	LBS/1000 FT
*	NEQ24136T	2160	22	600	36	24	.031	500.5	2.0
*	NEQ24236T	2162	19	1200	36	48	.062	263.4	3.8
*	NEQ24336T	2163	18	1800	36	72	.078	166.9	6.0
*	NEQ24426T	2164	16	2400	36	96	.109	126.6	7.9
*	NEQ24536T	2166	15	3000	36	120	.125	100.1	10.0
*	NEQ241036T	2167	12	6000	36	240	.156	50.1	20.0
*	NEQ24736T	2168	14	4200	36	168	.171	71.5	14.0
*	NEQ24834T	2170	11	7632	34	192	.203	39.4	25.4
*	NEQ241636T	2171	10	9600	36	384	.250	31.3	32.0
*	NEQ48836T	2172	10	9600	36	384	.375	31.3	32.0
*	NEQ241030T	2173	6	24000	30	240	.437	12.0	83.5
*	NEQ481136T	2174	9	13200	36	528	.500	22.8	44.0
	NEQ481030T	2175	3	48000	30	480	.562	5.9	170.4
*	NEQ481836T	2176	7	21600	36	864	.781	13.9	71.9
*	NEQL48730T	2177	5	33600	30	336	.875	8.5	117.0
*	NEQL48830T	2178	4	38400	30	384	1.000	7.5	133.7
*	NEQL48930T	2179	4	43200	30	432	1.125	6.6	150.4
*	NEQL481030T	2180	4	48000	30	480	1.250	5.9	170.4
	NEQL481130T	2181	3	52800	30	528	1.375	5.4	1833.8
	NEQL481230T	2182	2	57600	30	476	1.500	5.0	200.5
	NEQL24236SP	2191	19	1200	36	48	.062	256.4	3.9
	NEQL24436SP	2193	16	2400	36	96	.109	126.6	7.9
	NEQL24536SP	2194	15	3000	36	120	.125	100.1	10.00
	NEQL241036SP	2195	12	6000	36	240	.156	50.1	20.0
	NEQL24736SP	2196	14	4200	36	168	.171	71.5	14.0
	NEQL248334SP	2197	11	7632	34	1922	.203	39.4	25.4
	NEQL241636SP	2198	10	9600	36	384	.250	31.3	32.0
*	NEQL48734T	5151678	9	13356	34	336	.500	22.5	44.4
*	NEQL24530T	2171/1	9	12000	30	120	.281	25.0	40.0
*	NEQ481630T	2175/1	3	48000	30	480	.562	5.9	170.4



# PVC Insulated Ground Strap 300 Volt, 105° C

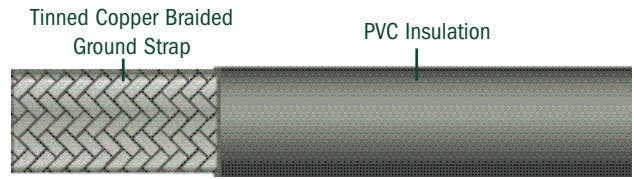

**DESCRIPTION:** Braided tin-plated copper conductor insulated with extruded PVC which is resistant to water, oil, acids and solvents and is self-extinguishing.

**USE:** Insulated bonds, grounds, leads, flexible connectors.

Typically constructed with tinned or bare copper wire, material may also be supplied to UL Style 1680; please contact our design team to assist you with a product for your specific application.

Equivalent AWG Size	Circular Mil Area	Wire AWG	Number of Wires	Braid Construction	BRAID DIMENSION		Nominal Wall	INSULATION DIMENSION	
					Nominal Width	Nominal Thickness		Nominal Width	Nominal Thickness
18	1800	36	72	24-3-36	.109	.025	.015	.139	.055
16	2400	36	96	24-4-36	.156	.025	.015	.186	.055
15	3000	36	120	24-5-36	.188	.025	.020	.228	.065
14	4200	36	168	24-7-36	.219	.031	.020	.259	.071
12	6000	36	240	24-10-36	.250	.040	.020	.290	.080
12	7200	36	288	48-6-36	.375	.031	.020	.415	.071
10	9600	30	96	24-4-30	.313	.050	.020	.353	.090
10	9600	36	384	24-16-36	.375	.063	.020	.415	.103
10	9600	36	384	48-8-36	.500	.031	.020	.540	.071
9	12000	30	120	24-5-30	.375	.050	.020	.415	.090
9	13200	36	528	48-11-36	.625	.040	.020	.665	.080
8	16800	30	168	24-7-30	.438	.063	.030	.498	.123
8	18000	36	720	48-15-36	.625	.040	.030	.685	.100
7	21600	36	864	48-18-36	.625	.050	.030	.685	.110
6	24000	30	240	24-10-30	.500	.094	.030	.560	.154
6	26400	36	1056	48-22-36	.875	.050	.030	.935	.110
5	36000	30	360	24-15-30	.625	.094	.030	.685	.154
4	43200	30	432	24-18-30	.719	.094	.030	.779	.154
3	48000	30	480	24-20-30	.750	.125	.030	.810	.185
2	64800	30	648	24-27-30	.938	.125	.030	.998	.185
1	76800	30	768	24-32-30	1.000	.125	.040	1.080	.205
1/0	105600	30	1056	24-44-30	1.250	.125	.040	1.330	.205

\* Material is manufactured to width specification; thickness dimensions are given as reference only and may vary slightly due manufacturing process inherent with braiding. Please contact your design team if you have specific thickness dimensions.

All measurements are in inches unless otherwise stated.

[www.newenglandwire.com](http://www.newenglandwire.com)  
Tel: 603.838.6624

## CABLES & STRANDS

New England Wire Technologies manufactures a broad range of flexible cables and strands which are used primarily in our specialty single and multiconductor cables. The uninsulated products are usually sold for use as motor brush leads, circuit breaker shunts and flexible bus bar.

The strands and cables listed in this section are made typically of bare or tinned copper wire but strands and cables for special purposes can be manufactured using silver-plated, pure silver, nickel-plated, pure nickel, stainless steel, monel or bronze as well as other metals and alloys.

Due to the widely diversified stranding and cabling processes utilized by New England Wire Technologies, we are able to offer a broad range of special application items including round, rectangular and trapezoidal configurations of superconducting cables. Please consult with our design team for assistance with your specific requirements.

We specialize in designing rope-lay cables, concentric and miniature bunched strands that offer the ultimate in flexibility. These stranded constructions complement our specialty insulated wire products, where flexibility and extended flex-life are primary considerations.

### **REINFORCED CABLES & STRANDS**

Conductors with increased tensile strength achieved by twisting wires or groups of wires around a non-conductive strength member.

### **CUSTOM ROPE-LAY CABLES & BUNCHED STRANDS**

Custom rope-lay cable and bunch-stranded conductors manufactured to customer specifications. Detailed product description or a sample of the custom conductor required.

### **COPPER ALLOYS**

High-strength copper alloys enabling increased tensile strength and extended flex-life as compared to conductors made with annealed copper.

### **LITZ WIRE**

Specialty conductors made up of individually film-insulated strands of copper or copper alloys. Additional information on Litz Wire is available in the Litz section of this catalog.



# Extra Flexible Rope-lay Stranded Copper Cables

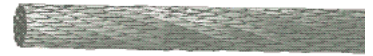

Although these cables are shown in tinned copper, they are also available in bare and silver-plated copper for use as motor brush leads, circuit breaker shunts and in other interconnect applications.

New England Part Number	CROSS SECTIONAL AREA			Number of Wires	Construction	Nominal OD	Nominal LBS/1000 FT
	Equivalent AWG	Circular Mil Area	SQ MM				
NER33546T	26	238	.13	105	3X35/46	.020	.82
NER32244T	26	264	.13	66	3X22/44	.020	.83
NER71544T	24	420	.21	105	7X15/44	.025	1.32
NER33544T	24	420	.21	105	3X35/44	.025	1.32
NER35044T	23	600	.30	150	3X50/44	.030	1.89
NER32240T	22	672	.32	66	3X22/40	.031	2.10
NER72444T	22	672	.39	168	7X24/44	.031	1.94
NER71540T	20	1009	.50	105	7X15/40	.039	3.18
NER73744T	20	1036	.50	259	7X37/44	.040	3.26
NER75044T	19	1400	.70	350	7X50/44	.046	4.41
NER72140T	19	1412	.70	147	7X21/40	.046	4.45
NER7936T	18	1575	.80	63	7X9/36	.049	4.96
NER72440T	18	1614	.80	168	7X24/40	.050	5.08
NER75944T	18	1652	.80	413	7X59/44	.050	5.20
NER77344T	17	2044	1.0	511	7X73/44	.056	6.44
NER73140T	17	2085	1.1	217	7X31/40	.056	5.57
NER71236T	17	2100	1.1	84	7X12/36	.057	6.61
NER71536T	16	2625	1.3	105	7X15/36	.063	8.26
NER79544T	16	2660	1.3	665	7X95/44	.064	8.37
NER74040T	16	2691	1.4	280	7X40/40	.064	8.47
NER711544T	15	3220	1.6	805	7X115/44	.070	10.14
NER71936T	15	3325	1.7	133	7X19/36	.071	10.47
NER75040T	15	3363	1.7	350	7X50/40	.072	10.59
NER71534T	14	4167	2.1	105	7X15/34	.080	13.12
NER72436T	14	4200	2.1	168	7X24/36	.080	13.22
NER735044T	14	4200	2.1	1050	7X3X50/44	.082	13.35
NER72140T	14	4238	2.1	441	7X3X21/40	.083	13.48
NER73036T	13	5250	2.7	210	7X30/36	.090	16.53
NER71934T	13	5278	2.7	133	7X19/34	.090	16.62
NER732640T	13	5247	2.7	546	7X3X26/40	.092	16.68
NER772744T	13	5292	2.7	1323	7X7X27/44	.097	17.30
NER79640T	12	6457	3.3	672	7X96/40	.099	20.33
NER73736T	12	6475	3.3	259	7X37/36	.099	20.38
NER72434T	12	6666	3.4	168	7X24/34	.101	20.99
NER773444T	12	6664	3.4	1666	7X7X34/44	.108	21.79
NER74736T	11	8225	4.2	329	7X47/36	.112	25.89
NER73034T	11	8334	4.2	210	7X30/34	.113	26.66
NER734140T	11	8274	4.2	861	7X3X41/40	.116	26.30
NER774244T	11	8232	4.2	2058	7X7X42/44	.121	26.91
NER73734T	10	10279	5.2	259	7X37/34	.125	32.36
NER75936T	10	10325	5.2	413	7X59/36	.126	32.50
NER71530T	10	10500	5.3	105	7X15/30	.127	33.05
NER735240T	10	10494	5.3	1092	7X3X52/40	.130	32.07
NER74734T	9	13058	6.6	329	7X47/34	.141	41.11
NER77536T	9	13125	6.7	525	7X75/36	.142	41.32
NER736540T	9	13117	6.6	1365	7X3X65/40	.146	40.41
NER71930T	9	13300	6.7	133	7X19/30	.143	41.87
NER75934T	8	16392	8.3	413	7X59/34	.158	51.60
NER773540T	8	16452	8.4	1712	7X7X35/40	.171	53.88

All measurements are in inches unless otherwise stated.

[www.newenglandwire.com](http://www.newenglandwire.com)

Tel: 603.838.6624

© 2005 New England Wire Technologies

# Extra Flexible Rope-Lay Stranded Copper Cables, *continued*

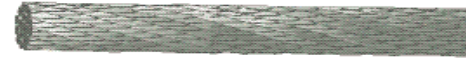

New England Part Number	CROSS SECTIONAL AREA			Number of Wires	Construction	Nominal OD	Nominal LBS/1000 FT
	Equivalent AWG Size	Circular Mil Area	SQ MM				
NER79536T	8	16625	8.4	665	7X95/36	.159	52.34
NER72430T	8	16800	8.5	168	7X24/30	.160	52.89
NER774440T	7	20719	10.5	2156	7X7X44/40	.191	67.73
NER711936T	7	20825	10.6	833	7X119/36	.178	65.60
NER77534T	7	20837	10.6	525	7X75/34	.178	65.60
NER73030T	7	21000	10.6	210	7X30/30	.179	66.11
NER73730T	6	25900	13.1	259	7X37/30	.199	81.53
NER715036T	6	26250	13.3	1050	7X150/36	.200	82.64
NER79534T	6	26393	13.4	665	7X95/34	.201	83.09
NER74740T	5	32900	16.8	329	7X47/30	.224	103.60
NER711934T	5	33061	16.8	833	7X119/34	.225	104.10
NER772736T	5	33075	16.8	1323	7X7X27/36	.242	108.10
NER75930T	4	41300	20.9	413	7X59/30	.242	130.00
NER773436T	4	41650	21.1	1666	7X7X34/36	.251	136.20
NER772234T	4	42785	21.7	1078	7X7X22/34	.271	139.90
NER77530T	3	52500	26.6	525	7X75/30	.275	165.30
NER774336T	3	52675	26.7	2107	7X7X43/36	.283	172.20
NER79530T	2	66500	33.7	665	7X95/30	.305	209.30
NER773434T	2	66123	33.5	1666	7X7X34/34	.319	216.20
NER775436T	2	66150	33.5	2646	7X7X54/36	.342	216.30
NER194430T	1	83600	42.4	836	19X44/30	.342	265.70
NER776836T	1	83300	42.2	3332	7X7X68/36	.367	272.30
NER774334T	1	83626	42.4	2107	7X7X43/34	.383	273.40
NER775434T	1/0	105019	53.2	2646	7X7X54/34	.384	343.30
NER778636T	1/0	105350	43.4	4214	7X7X86/36	.430	344.40
NER772230T	1/0	107800	54.6	1078	7X7X22/30	.431	352.40
NER776834T	2/0	132247	67.0	3332	7X7X68/34	.436	432.30
NER7710836T	2/0	132300	67.0	5292	7X7X108/36	.483	432.50
NER772430T	2/0	132300	67.0	1323	7X7X24/30	.483	432.50
NER773430T	3/0	166600	84.4	1666	7X7X34/30	.542	544.60
NER1973234T	3/0	168920	85.6	4256	19X7X32/34	.546	557.30
NER1975136T	3/0	169575	85.9	6783	19X7X51/36	.547	559.50
NER774330T	4/0	210700	106.8	2107	7X7X43/30	.610	688.80
NER1974034T	4/0	211151	107.0	6320	19X7X40/34	.610	696.70
NER1976436T	4/0	212800	107.8	8512	19X7X64/36	.613	702.10

All measurements are in inches unless otherwise stated.





# Standard Concentric & Unilay Constructions



The cables shown on this page are most commonly produced in either bare or tin-plated copper. Cables made with silver-plated or nickel-plated copper are also offered. Please consult our design team for your specific requirements.

Tin-plated copper and nickel-plated copper are not available for constructions using 48 or 50 AWG wire.

New England Part Number	Equivalent AWG Size	Number of Wires	Wire AWG	Nominal OD	Circular Mil Area	Direct Current Resistance OHMS/1000 FT	LBS/1000 FT
NEC750B	42	7	50	.003	7.00	1692.00	.021
NEC748B	40	7	48	.004	10.08	1079.00	.034
NEC746B	38	7	46	.005	17.92	672.90	.054
NEC744B	36	7	44	.006	28.00	423.90	.087
NEC742B	34	7	42	.008	43.75	264.90	.136
NEC740B	32	7	40	.009	67.57	169.60	.210
NEC738B	30	7	38	.012	112.00	100.30	.349
NEC736B	28	7	36	.015	175.00	63.56	.546
NEC734B	26	7	34	.019	277.83	39.40	.866
NEC732B	24	7	32	.024	448.00	24.45	1.397
NEC730B	22	7	30	.030	700.00	15.57	2.182



New England Part Number*	Equivalent AWG Size	Number of Wires	Wire AWG	Nominal OD	Circular Mil Area	Direct Current Resistance OHMS/1000 FT	LBS/1000 FT
NEU1950B	38	19	50	.005	19.00	629.600	.059
NEU1948B	36	19	48	.006	27.36	401.300	.092
NEU1946B	34	19	46	.007	48.64	250.300	.147
NEU1944B	32	19	44	.010	76.00	157.700	.239
NEU1942B	30	19	42	.012	118.75	98.550	.374
NEU1940B	28	19	40	.015	182.59	63.080	.575
NEU1938B	26	19	38	.019	304.00	37.320	.957
NEU1936B	24	19	36	.024	475.00	23.640	1.50
NEU1934B	22	19	34	.030	754.11	14.770	2.38
NEU1932B	20	19	32	.038	1216.00	9.096	3.83
NEU1930B	18	19	30	.048	1900.00	5.793	5.98

\*Preferred stranding.

New England Part Number	Equivalent AWG Size	Number of Wires	Wire AWG	Nominal OD	Circular Mil Area	Direct Current Resistance OHMS/1000 FT	LBS/1000 FT
NEC1950B	38	19	50	.005	19.00	629.600	.059
NEC1948B	36	19	48	.006	27.36	401.300	.092
NEC1946B	34	19	46	.008	48.64	250.300	.147
NEC1944B	32	19	44	.010	76.00	157.700	.239
NEC1942B	30	19	42	.013	118.75	98.550	.374
NEC1940B	28	19	40	.016	182.59	63.080	.575
NEC1938B	26	19	38	.020	304.00	37.320	.957
NEC1936B	24	19	36	.025	475.00	23.640	1.50
NEC1934B	22	19	34	.032	754.11	14.770	2.38
NEC1932B	20	19	32	.040	1216.00	9.096	3.83
NEC1930B	18	19	30	.050	1900.00	5.793	5.98

All measurements are in inches unless otherwise stated.

[www.newenglandwire.com](http://www.newenglandwire.com)  
Tel: 603.838.6624







## TECHNICAL REFERENCE

Raw Materials . . . . .	173
UL . . . . .	174
Alloy Information . . . . .	175
Annealed Bare & Silver-Plated Copper . . . . .	176
Annealed Tinned Copper - Round . . . . .	177
Single Film Coated - Round . . . . .	178
Heavy Film Coated - Round . . . . .	179
NEWtuf® Reinforced Jackets . . . . .	180
NEWcel® Foamed Dielectrics . . . . .	181
NEWtral® Low-Noise Cables . . . . .	182
NEWind® Specialty Winding Wire . . . . .	183
NE-F1® Class F Electrical Insulation System . . . . .	184
COLDflex Ground Cables™ . . . . .	185
NEWlan™ Networking Cables . . . . .	186
NEWguard™ Cables . . . . .	188
Hyflex Power™ Distribution Cables . . . . .	190
Glossary . . . . .	191

# RAW MATERIALS

New England Wire Technologies specializes in the design and manufacture of sophisticated wire and cable products for a diverse customer base. Our cables are used in such applications as medical electronics, robotics, defense electronics, power distribution, communications and alarm systems.

We maintain complete in-house control of the entire manufacturing process from the raw material state through specialty finishing and testing. Our in-house capabilities include: wire drawing and plating, conductor stranding and cabling, braiding and spiral shielding, metalized tape wrapping, polyester, PTFE, Kapton, Nomex and paper tape wrapping, textile braiding, conductor and jacket extruding, specialty printing, cable coiling and testing.

We also work with customer supplied materials; please call our design team to discuss your custom project.

## CONDUCTOR MATERIALS

- |                      |                      |
|----------------------|----------------------|
| Bare Copper          | High-strength Alloys |
| Oxygen Free Copper   | Specialty Alloys     |
| Tin-plated Copper    | Resistance Wire      |
| Gold-plated Copper   | Aluminium            |
| Silver-plated Copper | Copper Clad Steel    |
| Nickel-plated Copper | Precious Metals      |
| Stainless Steel      | Silver               |
| Tinsel Wire          | Platinum             |
| Magnet Wire          |                      |

## INSULATION MATERIALS

- |       |                 |
|-------|-----------------|
| PFA   | Polyester       |
| FEP   | Polyethylene    |
| PVC   | Polypropylene   |
| ETFE  | Polyurethane    |
| TPE   | Silicone Rubber |
| Nylon |                 |

## TEXTILES, TAPES & FILLERS

As a manufacturer of custom wire and cable products, New England Wire prides itself in having an extensive raw materials inventory that meets the needs of most of our custom orders. We maintain a wide variety of textiles, fillers and tapes that are RoHS compliant. Our textiles include nylons, cotton, dacron, polyester, glass, Nomex and polyester. For fillers we customarily stock and use vent tubes, jute, nylon, polyethylene, dacron, polyester, glass, seine cord, Kevlar®, PVC, cotton, polypropylene. Tape products used most frequently include PTFE, Kapton®, Mylar®, Nomex®, kraft, glass/fiberglass, Alumiflex, Lomiglass, stainless steel, paper tissue, aluminum/mylar, foam tape/PTFE and conductive and semi-conductive tapes. As always, we will special order products for your specific requirements.

Kevlar, Kapton, Mylar and Nomex are registered tradenames of E.I. DuPont.

## UL STYLE / CSA AVAILABILITY

New England Wire Technologies maintains an extensive list of UL/CSA approved materials. We have obtained over 450 UL Style approvals for appliance wiring materials, power/circuit cables, electrical wire and cables, flexible cords, fixture wire and communications cables. Our approvals include single and multiconductor cables with PVC, ETFE, FEP, PFA, silicone rubber, polyethylene and polypropylene insulation ranging from 2 mil walls up to 145 mil walls. Included in our approvals are cables up to 1000 volts and temperature rated to 200°C. Additionally we have approvals for coaxes to 600 volts and 105°C, coil cords and braided singles.

Please contact our technical design team to discuss your specific application. If we do not have the UL style you need we will be happy to work with you to obtain it.

The range of CSA approvals on file include cables with PVC, polyethylene, polyurethane, silicone rubber and fluoropolymers in various voltage and temperature ratings. We will, of course, work with you to obtain other approvals to meet your specific requirements.



## ALLOY INFORMATION

New England Wire Technologies offers a variety of alloy options for our wire and cable products including ETP Copper, oxygen-free copper, cadmium, phosphor-bronze and chromium. Many are RoHS compliant. Listed below are a sampling of them along with specific attributes of each; please contact our design team to discuss your specific requirement.

New England Designation	Conductivity	Tensile Strength <sup>1</sup>		Yield Strength <sup>2</sup>		Elongation <sup>3</sup>		Applicable ASTM	Other Information
		Soft	Hard	Soft	Hard	Soft	Hard		
<b>Bare Copper*</b> <b>NEWaloy 10</b>	100%	35000psi	60000psi	10000psi	50000psi	10-25%	1%	ASTM B3 ASTM B193 ASTM B 258	47-50 AWG are hard-drawn; all others are (soft) annealed.
<b>Bare OFHC*</b> <b>NEWaloy 21</b>	101%	35000psi	60000psi	10000psi	50000psi	10-25%	1%	ASTM B ASTM B193 ASTM B258	47-50 AWG are hard-drawn; all others are (soft) annealed.
NEWaloy 21 is New England Wire Technologies standard OFHC									
<b>Bare OFHC Grade 1*</b> <b>NEWaloy 11</b>	100%	35000psi	60000psi	10000psi	50000psi	10-25%	1%	ASTM B3 ASTM B193 ASTM B258	47-50 AWG are hard-drawn; all others are (soft) annealed.
<b>NEWaloy 13*</b>	70%	50000psi	85000psi	30000psi	80000psi	10-25%	1%	ASTM B105 ASTM B258	Information varies slightly according to size and coating.
<b>NEWaloy 61</b>	80%	40000psi	85000psi	20000psi	80000psi	10-25%	1%	ASTM B105 ASTM B193 ASTM B258	Information varies slightly according to size and coating.
<b>NEWaloy 75</b>	35%	40000psi	110000psi			10-25%	1%	ASTM B105 ASTM B193 ASTM B258	Information varies slightly according to size and coating.
<b>NEWaloy 81</b>	85%			40000psi				ASTM B624 ASTM B193 ASTM B258	47-50 AWG are hard-drawn; all others are (soft) annealed.
<b>NEWaloy 68*</b>	85%			40000psi				ASTM B624 ASTM B193 ASTM B258	47-50 AWG are hard-drawn; all others are (soft) annealed.

\* RoHs Compliant

<sup>1</sup> Typical

<sup>2</sup> Typical, 1% offset

<sup>3</sup> Typical, % in 10"





# Annealed Tinned Copper - Round

AWG Size	DIAMETER			CROSS SECTIONAL AREA		WEIGHT NOMINAL WIRE		RESISTANCE AT 20° C - 68° F NOM. WIRE	
	Min.	Nom.	Max.	Circular Mil Area	Sq. MM	LBS/1000 Ft.	Ft./LBS.	Ft./OHM	OHM/K Ft.
2	.2550	.2576	.2653	66358.00	33.6	200.9	4.98	6215.0	.1609
3	.2271	.2294	.2363	52624.00	26.7	159.3	6.28	4931.0	.2028
4	.2023	.2043	.2104	41738.00	21.1	126.3	7.92	3911.0	.2557
5	.1801	.1819	.1874	33088.00	16.8	100.2	9.98	3100.0	.3226
6	.1604	.1620	.1669	26244.00	13.3	79.44	12.59	2459.0	.4067
7	.1429	.1443	.1486	20822.00	10.6	63.03	15.87	1951.0	.5126
8	.1272	.1285	.1324	16512.00	8.37	49.98	20.01	1547.0	.6464
9	.1133	.1144	.1178	13087.00	6.63	39.62	25.24	1226.0	.8156
10	.1009	.1019	.1050	10383.00	5.26	31.43	31.82	962.5	1.039
11	.0898	.0907	.0934	8226.00	4.17	24.90	40.16	762.8	1.311
12	.0800	.0808	.0832	6529.00	3.31	19.76	50.61	605.3	1.652
13	.0713	.0720	.0742	5184.00	2.63	15.69	63.73	480.8	2.080
14	.0635	.0641	.0660	4109.00	2.08	12.44	80.39	381.0	2.625
15	.0565	.0571	.0588	3260.00	1.65	9.87	101.32	302.2	3.308
16	.0503	.0508	.0523	2581.00	1.31	7.812	128.00	239.3	4.179
17	.0448	.0453	.0466	2052.00	1.04	6.213	161.00	190.3	5.256
18	.0399	.0403	.0415	1624.00	.82	4.914	203.50	150.6	6.641
19	.0355	.0359	.0370	1289.00	.65	3.900	256.40	119.5	8.367
20	.0317	.0320	.0329	1024.00	.52	3.099	322.70	94.97	10.53
21	.0282	.0285	.0293	812.30	.41	2.459	406.70	75.30	13.28
22	.0250	.0253	.0261	640.10	.32	1.937	516.30	59.35	16.85
23	.0224	.0226	.0233	510.80	.26	1.546	646.80	47.37	21.11
24	.0199	.0201	.0207	404.00	.20	1.223	817.70	37.45	26.70
25	.0177	.0179	.0184	320.40	.16	.970	1031.00	29.09	34.38
26	.0157	.0159	.0164	252.80	.13	.765	1307.00	22.95	43.57
27	.0141	.0142	.0146	201.60	.10	.610	1639.00	18.30	54.63
28	.0125	.0126	.0130	158.80	.08	.481	2081.00	14.41	69.38
29	.0112	.0113	.0116	127.70	.065	.387	2587.00	11.59	86.26
30	.0099	.0100	.0103	100.00	.051	.303	3306.00	8.985	111.3
31	.0088	.0089	.0092	79.210	.040	.240	4170.00	7.112	140.6
32	.0079	.0080	.0083	64.00	.032	.194	5163.00	5.747	174.0
33	.0070	.0071	.0074	50.41	.026	.153	6553.00	4.529	220.8
34	.0062	.0063	.0066	39.69	.020	.120	8326.00	3.565	280.5
35	.0055	.0056	.0059	31.36	.016	.095	10537.00	2.817	355.0
36	.0049	.0050	.0053	25.00	.013	.076	13212.00	2.246	445.3
37	.0044	.0045	.0048	20.25	.010	.061	16319.00	1.819	549.8
38	.0039	.0040	.0043	16.00	.008	.049	20644.00	1.437	695.8
39	.0034	.0035	.0038	12.27	.006	.037	26969.00	1.100	908.8
40	.0030	.0031	.0034	9.61	.005	.029	34364.00	.863	1158.5
41	.0027	.0028	.0031	7.84	.004	.024	42123.00	.704	1420.0
42	.0024	.0025	.0028	6.25	.003	.019	52854.00	.561	1781.3
44	.0019	.0020	.0023	4.00	.002	.012	82645.00	.359	2783.3

All measurements are in inches unless otherwise stated.

www.newenglandwire.com

Tel: 603.838.6624

© 2005 New England Wire Technologies

# Single Film Coated - Round

AWG Size	Bare Wire Diameter Nominal	Film Addition Min	Film Addition Max.	Min OD	Nominal OD	Max OD	Weight @ 20°C - 68°F LBS/1000 FT Nominal	Weight @ 20°C - 68°F FT/LB Nominal	Resistance @ 20°C - 68°F OHMS/1000 FT Nominal	Resistance @ 20°C - 68°F OHMS/LB Nominal	Wires Per SQ Inch
8	.1285	.0016	.0026	.1288	.1306	.1324	50.23	19.91	.6281	.0125	59
9	.1144	.0016	.0026	.1149	.1165	.1181	39.80	25.13	.7925	.01991	74
10	.1019	.0015	.0025	.1024	.1039	.1054	31.57	31.68	.9987	.03163	93
11	.0907	.0015	.0025	.0913	.0927	.0941	25.05	39.92	1.261	.0503	116
12	.0808	.0014	.0024	.0814	.0827	.0840	19.93	50.18	1.588	.0797	146
13	.0720	.0014	.0023	.0727	.0739	.0750	15.81	63.25	2.001	.1266	183
14	.0641	.0016	.0023	.0651	.0658	.0666	12.50	80.00	2.524	.2019	230
15	.0571	.0015	.0022	.0580	.0587	.0594	9.95	100.50	3.181	.3197	288
16	.0508	.0014	.0021	.0517	.0524	.0531	7.89	126.7	4.018	.5093	363
17	.0453	.0014	.0020	.0462	.0468	.0475	6.26	159.7	5.054	.8073	455
18	.0403	.0013	.0019	.0412	.0418	.0424	4.97	201.2	6.386	1.2849	572
19	.0359	.0012	.0019	.0367	.0373	.0379	3.95	253.2	8.046	2.037	715
20	.0320	.0012	.0018	.0329	.0334	.0339	3.13	319.5	10.13	3.2364	896
21	.0285	.0011	.0018	.0293	.0298	.0303	2.483	402.7	12.77	5.143	1119
22	.0253	.0011	.0017	.0261	.0266	.0270	1.970	507.6	16.20	8.223	1403
23	.0226	.0010	.0016	.0234	.0238	.0243	1.565	639.0	20.30	12.971	1751
24	.0201	.0010	.0015	.0209	.0213	.0217	1.240	806.5	25.67	20.702	2204
25	.0179	.0009	.0014	.0186	.0190	.0194	.988	1012.1	32.37	32.763	2741
26	.0159	.0009	.0013	.0166	.0170	.0173	.784	1276	41.02	52.32	3460
27	.0142	.0008	.0013	.0149	.0152	.0156	.623	1605	51.44	82.57	4272
28	.0126	.0008	.0012	.0133	.0136	.0140	.495	2020	65.31	131.94	5407
29	.0113	.0007	.0012	.0119	.0122	.0126	.394	2538	81.21	206.12	6610
30	.0100	.0007	.0011	.0106	.0109	.0112	.312	3205	103.7	332.37	8417
31	.0089	.0006	.0010	.0094	.0097	.0100	.248	4032	130.9	527.8	10628
32	.0080	.0006	.0010	.0085	.0088	.0091	.1966	5086	162.0	824.0	12913
33	.0071	.0005	.0009	.0075	.0078	.0081	.1570	6369	205.7	1310	16437
34	.0063	.0005	.0008	.0067	.0070	.0072	.1244	8039	261.3	2100	20408
35	.0056	.0004	.0007	.0059	.0062	.0064	.0989	10111	330.7	3343	26015
36	.0050	.0004	.0007	.0053	.0056	.0058	.0788	12690	414.8	5264	31888
37	.0045	.0003	.0006	.0047	.0050	.0052	.0624	16026	512.1	8207	40000
38	.0040	.0003	.0006	.0042	.0045	.0047	.0494	20243	648.2	13121	49383
39	.0035	.0002	.0005	.0036	.0039	.0041	.0393	25445	846.6	21542	65746
40	.0031	.0002	.0005	.0032	.0035	.0037	.0313	31949	1079	34473	81633
41	.0028	.0002	.0004	.0029	.0031	.0033	.02470	40486	1323	53563	104058
42	.0025	.0002	.0004	.0026	.0028	.0030	.01946	51387	1659	85252	127551
43	.0022	.0002	.0003	.0023	.0025	.0026	.01548	64599	2143	138437	160000
44	.0020	.0001	.0003	.0020	.0022	.0024	.01233	81103	2593	210300	206611
45	.00176	.0001	.00022	.00179	.0019	.00205	.00965	103626	3348	346943	345304
46	.00157	.0001	.00021	.00161	.00173	.00185	.00767	130378	4207	548501	420521
47	.00140	.0001	.00024	.00145	.00158	.00170	.00615	162601	5291	860325	510204
48	.00124	.0001	.00021	.00129	.00140	.00150	.00487	205338	6745	1385010	649773

All measurements are in inches unless otherwise stated.



# Heavy Film Coated - Round

AWG Size	Bare Wire Diameter Nominal	Film Addition Min	Film Addition Max.	Min OD	Nominal OD	Max OD	Weight @ 20°C - 68°F LBS/1000 FT Nominal	Weight @ 20°C - 68°F FT/LB Nominal	Resistance @ 20°C - 68°F OHMS/1000 FT Nominal	Resistance @ 20°C - 68°F OHMS/LB Nominal	Wires Per SQ Inch
8	.1285	.0033	.0044	.1305	.1319	.1332	50.42	19.83	.6281	.01246	57
9	.1144	.0032	.0043	.1165	.1177	.1189	39.97	25.02	.7925	.01983	72
10	.1019	.0031	.0042	.1050	.1056	.1061	31.72	31.53	.9987	.03148	90
11	.0907	.0030	.0041	.0928	.0938	.0948	25.18	39.71	1.261	.0501	112
12	.0808	.0029	.0039	.0829	.0837	.0847	20.03	49.93	1.588	.0793	141
13	.0720	.0028	.0038	.0741	.0749	.0757	15.90	62.89	2.001	.1258	176
14	.0641	.0032	.0037	.0667	.0675	.0682	12.57	79.55	2.524	.2008	221
15	.0571	.0030	.0036	.0595	.0602	.0609	10.01	99.90	3.181	.3178	276
16	.0508	.0029	.0035	.0532	.0539	.0545	7.95	125.79	4.018	.5054	344
17	.0453	.0028	.0034	.0476	.0482	.0488	6.32	158.23	5.054	.7997	429
18	.0403	.0026	.0033	.0425	.0431	.0437	5.02	199.2	6.386	1.2721	536
19	.0359	.0025	.0032	.0380	.0386	.0391	3.99	250.6	8.046	2.0165	668
20	.0320	.0023	.0030	.0340	.0346	.0351	3.16	316.5	10.13	3.2057	835
21	.0285	.0022	.0029	.0304	.0309	.0314	2.51	398.4	12.77	5.088	1041
22	.0253	.0021	.0028	.0271	.0276	.0281	1.99	502.5	16.20	8.141	1303
23	.0226	.0020	.0027	.0244	.0249	.0253	1.59	628.9	20.30	12.767	1613
24	.0201	.0019	.0026	.0218	.0223	.0227	1.260	793.7	25.67	20.373	1993
25	.0179	.0018	.0025	.0195	.0199	.0203	1.005	995.0	32.37	32.209	2475
26	.0159	.0017	.0024	.0174	.0178	.0182	.799	1252	41.02	51.34	3086
27	.0142	.0016	.0022	.0157	.0161	.0164	.634	1577	51.44	81.14	3858
28	.0126	.0016	.0021	.0141	.0144	.0147	.504	1984	65.31	129.58	4823
29	.0113	.0015	.0020	.0127	.0130	.0133	.401	2494	81.21	202.52	5917
30	.0100	.0014	.0019	.0113	.0116	.0119	.318	3145	103.7	326.10	7432
31	.0089	.0013	.0018	.0101	.0105	.0108	.254	3937	130.9	515.4	9070
32	.0080	.0012	.0017	.0091	.0095	.0098	.2019	4953	162.0	802.4	11080
33	.0071	.0011	.0016	.0081	.0085	.0088	.1611	6207	205.7	1276.8	13841
34	.0063	.0010	.0014	.0072	.0075	.0078	.1269	7880	261.3	2059.1	17778
35	.0056	.0009	.0013	.0064	.0067	.0070	.1010	9901	330.7	3274.3	22277
36	.0050	.0008	.0012	.0057	.0060	.0063	.0803	12453	414.8	5166	27778
37	.0045	.0008	.0011	.0052	.0055	.0057	.0641	15601	512.1	7989	33058
38	.0040	.0007	.0010	.0046	.0049	.0051	.0509	19646	648.2	12735	41649
39	.0035	.0006	.0009	.0040	.0043	.0045	.0403	24814	846.6	21007	54083
40	.0031	.0006	.0008	.0036	.0038	.0040	.0319	31348	1079	33824	69252
41	.0028	.0005	.0007	.0032	.0034	.0036	.0252	39683	1323	52500	86505
42	.0025	.0004	.0006	.0028	.0030	.0032	.0199	50251	1659	83367	111111
43	.0022	.0004	.0006	.0025	.0027	.0029	.0159	62893	2143	134780	137174
44	.0020	.0004	.0006	.0023	.0025	.0027	.0127	78740	2593	204173	160000

All measurements are in inches unless otherwise stated.

[www.newenglandwire.com](http://www.newenglandwire.com)

Tel: 603.838.6624

© 2005 New England Wire Technologies

# NEWtuf® REINFORCED JACKETS

## TECHNICAL INFORMATION

Silicone rubber is preferred over other jacketing materials due to its high flexibility, performance at high temperatures and ease of sterilization. Certain medical applications require that cable jackets be cleaned by wiping the surface with solvents. Conventional silicone rubber jackets may become stretched and distorted during the cleaning process. Furthermore it is desirable to limit the elongation of the jacket in some silicone rubber jacketed cable assemblies when equipped with molded connectors.

With a peak strength three times that of conventional silicone rubber, NEWtuf® reinforced jackets withstand axial forces without reducing flexibility. Although tougher than conventional silicone rubber, the jacket can still be easily stripped with standard equipment.

150°C/300V UL AWM Sties are available for medical instrument interconnecting cable applications.

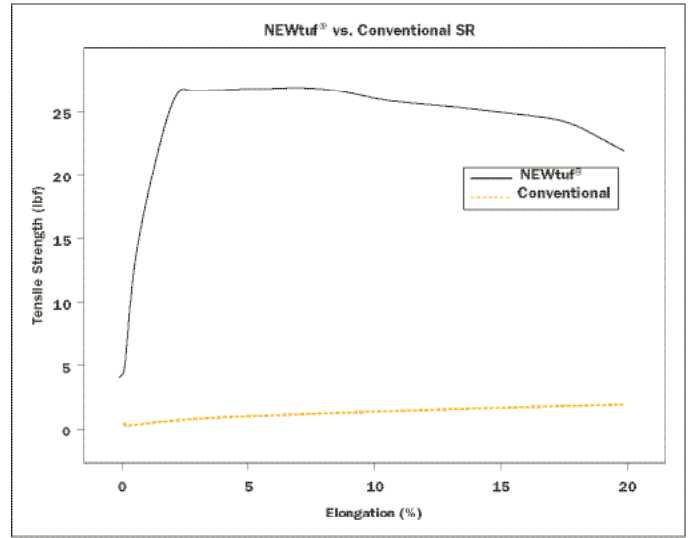

When a force is applied, NEWtuf® exhibits very little elongation unlike conventional silicone rubber jackets.

## PRODUCT ADVANTAGES

- \* High Tensile Strength
- \* Low Elongation
- \* Autoclavable
- \* High Flexibility
- \* Excellent High-Temperature Integrity

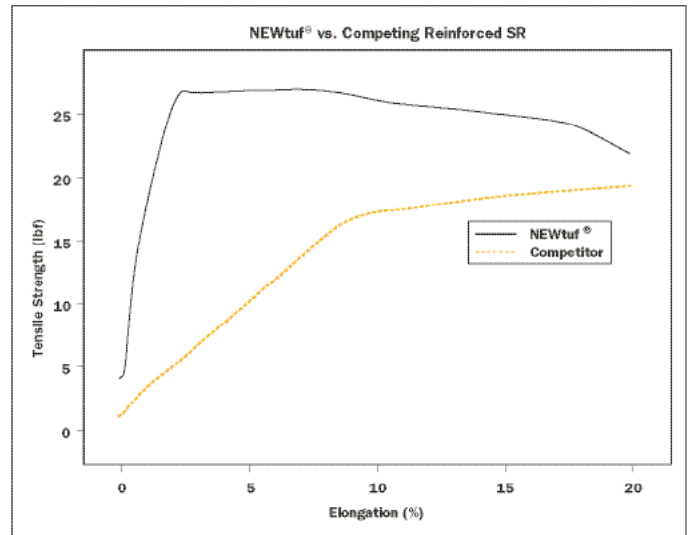

A comparison of the performance of NEWtuf® vs. competing reinforced jackets proves NEWtuf® to be superior.

## Material Properties

Property	Conventional	NEWtuf®	Competitor
Elongation 5 lbf	86%	0.03%	2.0%
Elongation 20 lbf	490%	1.0%	20%



# NEWcel® FOAMED DIELECTRICS

## TECHNICAL INFORMATION

Air is a near perfect dielectric medium allowing a signal to propagate through it at approximately the speed of light. However, an air dielectric is impractical for use as a cable insulation as it provides no structural integrity. Thus, manufacturers resort to using materials with higher dielectric constants (lower propagation velocity) to meet physical requirements.

NEWcel® is the perfect solution. A closed-cell foamed dielectric material specifically designed to reduce dielectric constant and dissipation factor yielding low-capacitance, low-loss, high V.O.P. ultraminiature coaxial, triaxial and twinaxial cables.

Typical coaxial, triaxial and twinaxial cables are manufactured using low dielectric constant (2.0 - 2.6) materials that possess inherently better electrical properties than standard insulation material such as PVC. Using highly controlled extrusion processes, these materials are foamed yielding a dielectric medium with a high air concentration. The result of this process is a significantly reduced dielectric constant (1.45 - 1.8) that approaches the nearly ideal properties of air without sacrificing structural integrity. This results in a significant capacitance reduction while providing the customer with the choice of reduced diameter/same attenuation or same diameter/reduced attenuation.

MATERIAL PROPERTIES				
Property	-B04	-B05	-GX20	-GX16
Temperature Rating	80° C	80° C	150° C	200° C
Dielectric Constant	1.80	1.60	1.60	1.45
Propagation Velocity	74.5%	79.0%	79.0%	82.5%

## PRODUCT ADVANTAGES

- \* Reduces Attenuation
- \* Reduces Cable Size
- \* Reduces Capacitance
- \* Wide Temperature Range

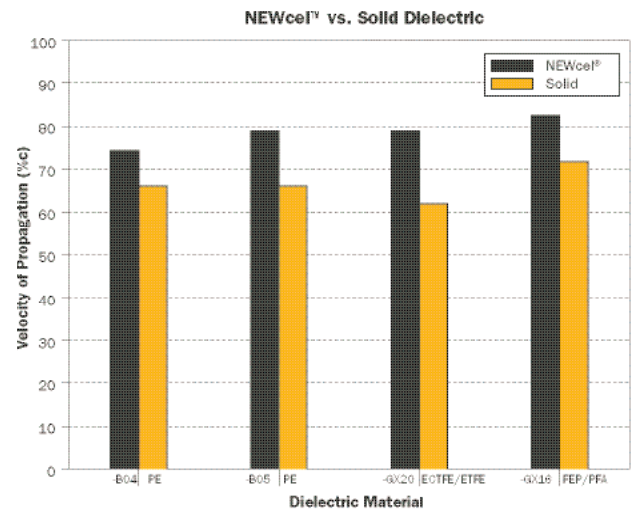

A comparison of the propagation velocity of a signal through NEWcel® and equivalent solid dielectric materials.

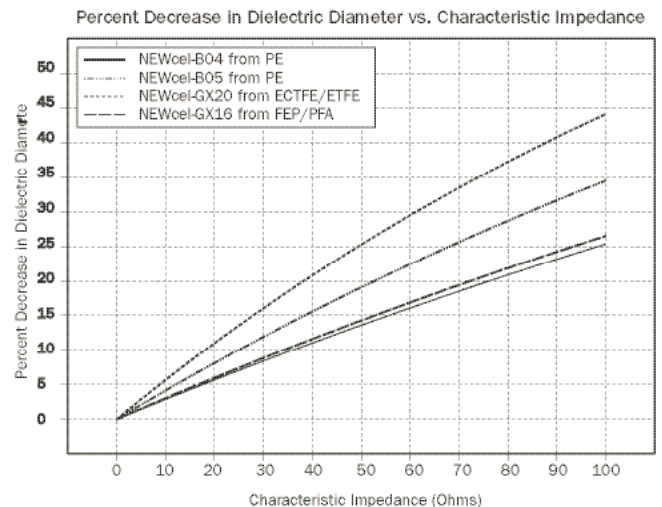

An estimated percent decrease in dielectric diameter resulting from switching to NEWcel® from equivalent solid dielectric materials if the characteristic impedance is constant.

[www.newenglandwire.com](http://www.newenglandwire.com)

Tel: 603.838.6624

# NEWtral® LOW-NOISE CABLES

## TECHNICAL INFORMATION

In small signal applications, noise-free transmission lines are necessary to maintain signal integrity. Simply flexing or twisting a traditional cable can generate voltage spikes with magnitudes in the tens of millivolts. This noise is due to triboelectric charging of the insulator materials, which act as capacitors and store the charge. The addition of conductive low-noise layers reduces this noise to the microvolt range.

New England Wire Technologies has specifically developed a range of advanced low-noise cables designed to neutralize noise generated by mechanical shock and vibration and maximize signal quality.

Typical applications include medical equipment, test and measurement equipment, charge amplifiers, vibration analyzers and oscilloscopes.

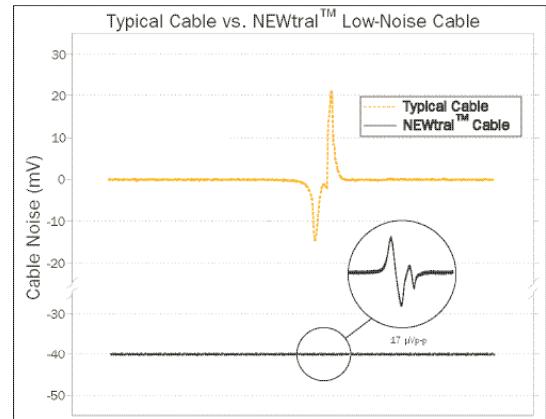

## NEWtral® Type 1

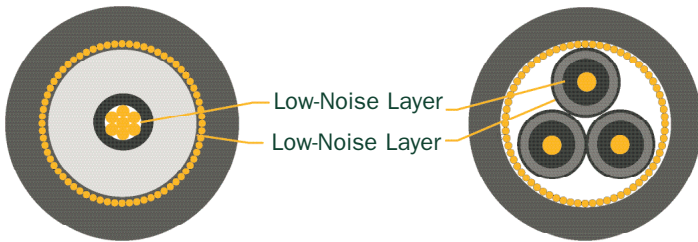

**Advantage:**

Excellent performance (10  $\mu$ V - 100  $\mu$ V)

**Consideration:**

Increase in primary diameter (.010"-.020")

## NEWtral® Type 2

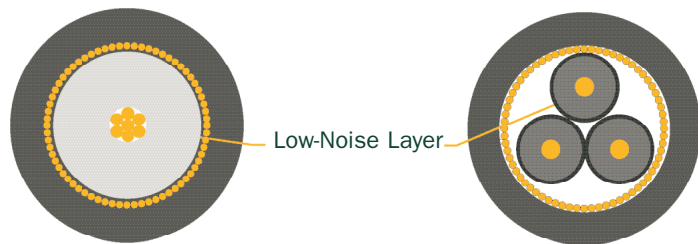

**Advantage:**

Very good performance (25  $\mu$ V - 250  $\mu$ V)

**Consideration:**

Low cost

## Outer Low-Noise Layer Options

**Extruded**

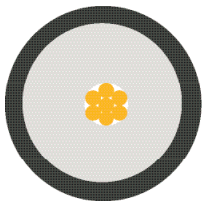

**Advantage:**

- \*Can be stripped mechanically.
- \*Low cost

**Consideration:**

- \*Diameter increase (.010-.020")

**Coated**

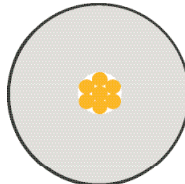

**Advantage:**

- \*No diameter increase.
- \*Low Cost

**Consideration:**

- \*Must be chemically stripped

**EZ- Strip**

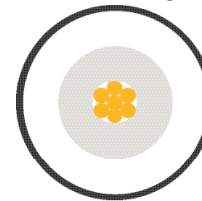

**Advantage:**

- \*Can be stripped mechanically.
- \*No diameter increase.

**Consideration:**

- \*Higher Cost



# NEWind® Specialty Winding Wire

## TECHNICAL INFORMATION

The most common winding wire is magnet wire in either its single-end or stranded “Litz” form. Magnet wire coating, however is generally not sufficient for insulating between winding turns, separate windings and between the winding and ground as the magnet wire coating can easily be damaged. It is for this reason that additional interleaved insulation is needed.

NEWind® Specialty Winding Wire eliminates the need for this additional insulation by insulating conductors with thin layers of insulation extruded in single (Basic), two (Supplemental) or three (Reinforced) layers. Basic NEWind® is recommended when a rating of 600 Vpk and the smallest possible diameter are required. Supplemental and Reinforced NEWind® are used where a more rugged product is required to withstand mechanical handling and maintain an electrical rating up to 1000 Vpk. These products are also approved under our NE-F1 Electrical Insulation System.

Multiple Insulation on Complex Bundles



Multiple Insulation on Single Strand

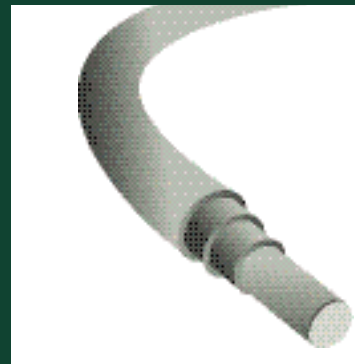

## PRODUCT DETAILS

- UL 60950/IEC 60950 Annex U Approved
- UL 1446 Electrical Insulation System: NE-F1 - Class F (155°C)
- Single-End, Stranded and Litz Conductors
- Supplementary and Reinforced Insulations

## MATERIAL PROPERTIES

	ETFE	FEP	PFA
Temperature Rating*	155°C	180°C	200°C*
Layer Thickness Basic (Minimum)	.0015"	.002"	.002"
Total Thickness Supplementary (Minimum)	.003"	.004"	.004"
Total Thickness Reinforced (Minimum)	.0045"	.006"	.006"

\*UL60950 & VDE 60950 have a maximum temperature rating of 180°C Class H.

[www.newenglandwire.com](http://www.newenglandwire.com)

Tel: 603.838.6624

# NE-F1 Class F (155° C) Electrical Insulation System

**TECHNICAL INFORMATION** Electrical insulation systems are invaluable to coil and transformer designers as they eliminate the need for long term component testing. Combining the regulatory approvals of NE-F1 with the capabilities and experience of New England Wire Technologies at producing high performance winding wire products allows us to provide unique solutions to meet design challenges associated with today’s winding needs.

NE-F1 Class F (155°C) Electrical Insulation System was developed as a solution to cost, size and time saving issues. Extensive research and component testing allow us to provide a complete range of materials that are ideal for transformer, motor and coil designs leading to higher efficiency, smaller, lower cost devices that can be brought to market without longterm testing delays.

NE-F1 features NEWind™ Specialty Winding Wires which are designed to eliminate the need for separate ground, interwinding and turn insulation. This results in a smaller device that performs equivalent to, if not better than, the bulky and costlier larger devices.

NE-F1 also features a wide variety of bobbin materials, tapes, sleeving, potting compounds and varnishes. This diverse selection of material ensures that NE-F1 will be suitable for the need for multiple Electrical Insula

INSULATION SYSTEM - MAJOR COMPONENTS	
<b>Magnet Wire (Winding Wire)</b>	
Category	Components
Polyester	MW30, MW35, MW73, MW74, MW76
Polyester (Solderable)	MW77, MW78
Polyurethane (Solderable)	MW79, MW80, MW82, MW83
NEWind® Winding Wire	ETFE, FEP, PFA
<b>Ground and Interwinding Insulation</b>	
Supplier	Components
E. J. DuPont	Kapton HN
	Nomex 410, 414, 416, 418
	PIFE
	Rynite 530, FR530, FR530L, FR943
Sumitomo Bakelite	Zenite 6130
	E4008
-	PM-9630
-	PET RLM
<b>Varnishes</b>	
Supplier	Components
John C. Dolph	AC-43
	BC-346A, BC-346B, BC-346-AN, BC-346F
	BC359
	BC365
Ripley Resin Engineering	CC-1105
	468-2
Viking Products	V1380FC
	V1630FS

**PRODUCT DETAILS** UL recognized for Class F (155° C) applications:  
 OBJS2 File E231977  
 Component IEC 60085  
 CAN/CSA C22.2 No. 0-M91, Appendix B

Approved for use in the construction of transformers, motors and coils. Provides a large selection of major and minor component materials to support any application.



# COLDflex Ground Cable™

## TECHNICAL INFORMATION

**COLDflex Ground Cable™ product line is specifically designed for flexible, low-temperature ground cable applications. Tested for cold weather flexibility down to -40°C, COLDflex Ground Cables are UV resistant and have operating voltages up to 5kV.**

**Manufactured using highly stranded bare copper conductors, COLDflex Ground Cable™ standard conductor sizes and constructions are listed below. Ultra flexible stranded conductors are also available in a variety of conductor materials. Please contact our design team for more specific information or to discuss your specific requirements.**

**Our high performance compounds are specifically formulated for use where cold weather flexibility, UV resistance and high dielectric strength are required. Standard jacket colors include: white, black, red, green, yellow, blue, brown, orange, gray and violet. Custom colors and printing are available upon request.**

## PRODUCT ADVANTAGES

- \* Tested for cold weather flexibility down to -40° C
- \* UV resistant
- \* Operating voltages up to 5kV
- \* High dielectric strength
- \* Standard bare copper conductors; also available in variety of other conductor materials
- \* Standard sizes 250 kCMA - 4 AWG  
Other sizes available upon request
- \* Available in 10 standard colors
- \* Standard and custom surface printing available

Part Number	CONDUCTOR INFORMATION				INSULATION INFORMATION			WEIGHT
	Equivalent Size	Number of Strands	AWG of Strand	Nominal Outside Diameter*	Wall Thickness	Nominal Outside Diameter	Tolerance	LBS per 1000 FT
N48-30B-802	250 kCMA	2499	30	0.635"	0.085"	0.805"	+/- .020"	871.8
N48-30B-803	4/0 AWG	2121	30	0.585"	0.085"	0.755"	+/- .020"	746.6
N48-30B-755	3/0 AWG	1680	30	0.521"	0.085"	0.691"	+/- .020"	599.2
N48-30B-756	2/0 AWG	1344	30	0.466"	0.085"	0.636"	+/- .020"	486.5
N48-30B-757	1/0 AWG	1071	30	0.416"	0.085"	0.586"	+/- .020"	394.3
N48-30B-701	2 AWG	665	30	0.319"	0.065"	0.449"	+/- .016"	240.9
N48-30B-650	4 AWG	413	30	0.251"	0.065"	0.381"	+/- .016"	156.0

\*Conductor O.D. is determined when the cable is under tension during the extrusion process. Please request a sample of cable for evaluation prior to making decisions regarding connectors to be used with these cables.

**Reference documents:** ASTM B3-specification for soft or annealed copper wire; ASTM B 33-specification for tinned soft or annealed copper for electrical purposes; ASTM B 286-specification for copper conductors in hook-up wire for electronic equipment; CSA C22.2 No. 3-01 Test methods for electrical wires and cables; and UL 1581 Standard for Safety for Electrical Wires, Cables.

[www.newenglandwire.com](http://www.newenglandwire.com)

Tel: 603.838.6624

# NEWlan™ Networking Cables

We offer distributors some of the highest performing Networking Cables available on the market today. Our NEWlan™ series of cables meet or exceed all the applicable TIA/EIA specifications. They offer excellent bandwidth for current 1 Gbit/second Ethernet applications as well as emerging applications like IP based full motion video, IP based security, voice over IP and 10G Ethernet applications. These cables will allow you to maximize your investments for years to come. Available to distributors in ocean container shipments directly from our facilities in China.

## NEWlan™ Category-6E Gold

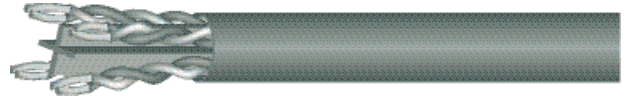

**DESCRIPTION:** 4 unshielded twisted pair cable using proprietary design and manufacturing techniques. 23 AWG bare copper center conductor, Polyolefin insulation, pairs with staggered lays, a cross-web filler and PVC jacket.

OD = 0.265 inches

Bending Radius = Minimum 1 inch

Available on reel or reel in a box

- Highest margin product available. 8-dB headroom in NEXT and ACR versus TIA/EIA.
- Tested to 600 Mhz with verified stability.
- 34% increase in signal strength at 100 Mhz and 50% increase at 250 Mhz.
- 3-year warranty on the cable.
- UL listed Type CMR and ETL verified to TIA/EIA 568-B.2-1 Cat 6.

## NEWlan™ Category-6 Premium

**DESCRIPTION:** 4 unshielded twisted pair cable utilizing 23 AWG bare copper center conductor, Polyolefin insulation, pairs with staggered lays, a cross-web filler and PVC jacket.

OD = 0.240 inches

Bending Radius = Minimum 1 inch

Available on reel or reel in a box

- Premium cable with a minimum 3 dB improvement in NEXT and ACR versus Cat-6.
- 1-year warranty of the cable.
- UL listed Type CMR and ETL verified to TIA/EIA 568-B2-1 Cat 6.

## NEWlan™ Category-6 Patch Cable

**DESCRIPTION:** 4 unshielded twisted pair cable utilizing 24 AWG stranded bare copper center conductor, Polyolefin insulation, pairs with staggered lays, a cross-web filler and PVC jacket.

OD = 0.250 inches

Bending Radius = Minimum 1 inch

Available on reel or reel in a box

- For making equipment cords and crossconnect cords in horizontal cabling system.
- 1-year warranty on the cable
- UL listed Type CMR and ETL verified to TIA/EIA 568-B.2-1 Cat 6 Patch Cable.



## NEWlan™ Networking Cables, *continued*

### NEWlan™

#### Category-5e Premium:

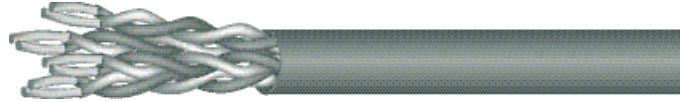

**DESCRIPTION:** 4 pair unshielded twisted pair cable with 24 awg solid bare copper conductor, Polyolefin insulation, staggered pair lays, PVC jacket.

- Exceeds TIA/EIA standards. Minimum 5-dB improvement in NEXT.
- Tested to 350 Mhz with verified stability.
- 1-year warranty on the cable.
- UL Listed Type CMR and ETL verified to TIA/EIA-568-B.2 Category-5e.

### NEWlan™

#### Category 5e Patch

**DESCRIPTION:** 4 pair unshielded twisted pair cabled with 24 awg stranded bare copper conductor, Polyolefin insulation, staggered pair lays, PVC jacket.

- For making equipment cords and crossconnect cords in horizontal cabling systems.
- 1-year warranty on the cable.
- UL Listed Type CMR and ETL verified to TIA/EIA-568-B.2 Category-5e Patch.

NEWlan™ Category-6 and Category-5e with overall foil shield are also available.

NEWlan™ Networking Cables for Rugged Environment can be manufactured using specialty jacket materials. Please contact our specialty sales team to discuss your specific requirements.

### NEWlan™

#### Hybrid Bundled Cable for Home Automations



NEWlan™ Hybrid Bundled Cable is a composite cable consisting of two Category 5e 100-Ohm cables, two RG-6/U 75 Ohm Quad shielded coaxial cables with or without two simplex fiber optic cables. The elements can be cabled together and skip-bound or jacketed with an outer PVC jacket.

- For installation where LAN and coaxial connectivity are required.

[www.newenglandwire.com](http://www.newenglandwire.com)

Tel: 603.838.6624

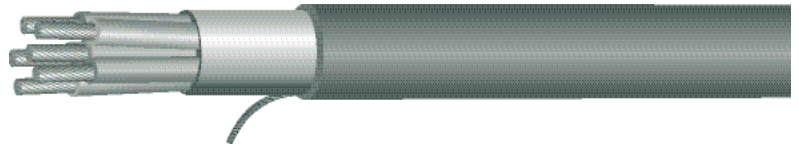

Our NEWguard™ cables are custom designed for the most challenging and demanding environments. In extreme conditions, cable becomes a critical link that supplies low voltage power, control and data signals. NEWguard™ cable remains flexible while meeting environmental challenges such as extreme temperature, mechanical abuse, presence of strong chemicals, exposure to oils, dust, wind, salt water spray and vibration.

NEWguard™ range of cables is designed around specially formulated grades of jacketing materials for challenging environments. We offer the following options:

- NEWguard™ 1** Special high molecular weight PVC that is chemical, oil and flame resistant.
- NEWguard™ 2** Polyurethane material that is abuse resistant, puncture and abrasion resistant, flame retardant, chemical resistant, oil resistant and hydrolysis resistant.
- NEWguard™ 3** Polyethylene black jacketing material that is sunlight resistant, outdoor resistant.
- NEWguard™ 4** Thermoplastic Elastomer material that is suitable for very cold and hot temperatures.
- NEWguard™ 5** Fluorocopolymer material that is suitable for very high temperature, and inert to every common chemical and oil.

In some cases, we can also recommend our proprietary NEWtuf™ line of cables with reinforced silicone rubber jackets or other crosslinked jacketing materials. Please contact our design team for cables manufactured to meet your specific needs.

New England Wire Technologies has sophisticated capabilities in conductor manufacturing, high technology insulation materials, and a variety of shielding options all designed for your specific requirements.

## CONDUCTOR OPTIONS

- Conductors of high strength, high conductivity metal alloys. 42 AWG to 4/0 AWG.
- Conductors of Electrolytic tough pitch, oxygen free, tinned and silver plated copper. 42 AWG to 4/0 AWG.
- Ultra fine stranding, rope lay constructions for super flexibility. Each strand 30-50 AWG.
- High performance, small diameter insulations systems. Fluoropolymers, Polyolefins, PVC.
- Strength members.
- Constructions designed for continuous flexing applications. The flexing can be rolling flex, bending flex or torsional flex application.

## REGULATORY APPROVALS

We offer a broad range of UL and CSA approvals for 300 and 600 volt cables. For new applications, we can also obtain a special regulatory approval.



NEWguard™ cables are designed for a diverse range of low voltage power, control and data signal applications in challenging environments. We can custom design small diameter, very flexible cables for high flex life and electromagnetic noise immunity.

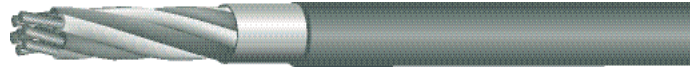

**APPLICATIONS OF NEWguard™ CABLES:**

- Chemical, petrochemical plants
- Wood, paper and pulp plants
- Automotive factories
- Steel, glass and metal foundries
- Mining industry
- Military ground support systems
- Arctic environments
- Down-hole pump applications
- Conveyor lines
- Mass transit systems
- Food and beverage plants
- CNC machining centers
- Packaging machinery

- Oil fields and geophysical exploration equipment
- Earth moving machinery with vibration concerns
- Clean room environment
- Satellite communications
- Inter-building communications
- Land irrigation systems
- Outdoor security systems
- Outdoor scoreboard and displays
- Pipeline sensor controls.

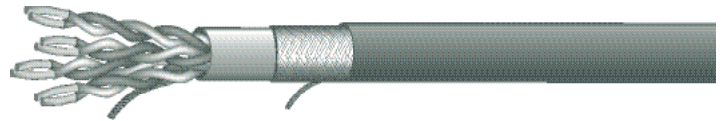

**PROPERTY COMPARISON, NEWguard™ JACKETING OPTIONS:**

PROPERTY	NEWguard™1	NEWguard™2	NEWguard™3	NEWguard™4	NEWguard™5*
Temperature, ° C	-20° to +80°	-20° to +80°	-20° to +80°	-40° to +105°	-60° to +150°
Jacket hardness, Shore	80-82 A	86-88 A	82 C	82 C	75 D
Abrasion resistance	Good	Very Good	Very Good	Good	Excellent
Cut through resistance	Fair	Very Good	Good	Good	Excellent
Flame resistance	Good	Good	Poor	Good	Excellent
Sunlight resistance	Good	Good	Very Good	Good	Excellent
Oil resistance**	Good	Good	Good	Good	Excellent
Chemical resistance**	Good	Very Good	Very Good	Good	Excellent
Salt water resistance**	Very Good	Good	Very Good	Very Good	Excellent
Dusty environment	Good	Very Good	Very Good	Good	Excellent
Vibration	Special designs for vibration resistance. Also special installation techniques.				
Flexibility	Very Good	Very Good	Fair	Good	Fair
Continuous flexing	Yes, custom design	Yes, custom design	No	Yes, custom design	No
Electrical noise immunity	Custom designs for high levels of immunity.				
Cable OD	Custom designs for small diameters with small conductors, insulations.				

\* NEWguard™ 5 rated - 80 to 200°C also available.

\*\*Chemical resistance data are for brief exposures (like splashes) to common industrial cleaning chemicals, oils, mild acids and mild bases. For more severe chemical resistance needs, please contact our design engineering team.

**www.newenglandwire.com**  
**Tel: 603.838.6624**

# HYflex™ Power Distribution Cables

## TECHNICAL INFORMATION

HYflex™ power distribution cables are specifically engineered to handle the high voltage and temperatures inherent with today's diesel hybrid vehicles. Independently tested to meet the requirements of SAE J 1654 and 1127, the HYflex™ line of cables is rated for use at 125°C and up to 600 volts.

HYflex™ cables are manufactured using high strand count tinned copper conductors. Standard sizes and constructions are listed below, however ultra flexible strandings and a variety of conductor materials are also available. Please contact our design team to discuss your specific requirement.

HYflex™ incorporates a uniquely designed, high performance compound specifically formulated for use in heavy duty diesel hybrid vehicles and high strand count, flexible conductors to produce cables ideally suited for applications where flexibility, long life and performance is critical. These cables have also been tested to meet the stringent flame test requirements of VW-1 flame test per Underwriters Laboratories Standard for Safety UL1581.

## PRODUCT ADVANTAGES

- \* Extra flexible high strand count, tinned copper conductors
- \* Meets SAE J 1654 & 1127 for 600 volt and 125°C diesel applications
- \* Improved flexibility over XLPO insulations
- \* Improved chemical resistance, temperature rating and cold weather performance vs. PVC
- \* Available in shielded and multiconductor configurations
- \* RoHS compliant
- \* Available in 10 standard colors

Part Number*	CONDUCTOR INFORMATION				INSULATION INFORMATION			WEIGHT
	Equivalent Size	Number of Strands	AWG of Strand	Nominal Outside Diameter**	Wall Thickness	Nominal Outside Diameter	Tolerance	LBS per 1000 FT
N48-30T-802	250 kCMA	2499	30	0.635"	0.088"	0.811"	+/- .020"	880.1
N48-30T-801	4/0 AWG	2121	30	0.585"	0.088"	0.761"	+/- .020"	754.0
N48-30T-752	3/0 AWG	1680	30	0.521"	0.088"	0.697"	+/- .020"	606.2
N48-30T-751	2/0 AWG	1344	30	0.466"	0.088"	0.642"	+/- .020"	492.9
N48-30T-753	1/0 AWG	1071	30	0.416"	0.088"	0.592"	+/- .020"	400.2
N48-30T-700	1 AWG	833	30	0.367"	0.066"	0.499"	+/- .016"	300.8
N48-30T-701	2 AWG	665	30	0.319"	0.066"	0.451"	+/- .016"	245.6
N48-30T-650	3 AWG	525	30	0.283"	0.066"	0.415"	+/- .016"	196.4
N48-30T-651	4 AWG	413	30	0.251"	0.066"	0.383"	+/- .016"	158.2
N48-30T-600	5 AWG	329	30	0.224"	0.066"	0.356"	+/- .016"	129.4
N48-30T-601	6 AWG	259	30	0.199"	0.066"	0.331"	+/- .016"	105.1
N48-30T-550 ^	7 AWG	210	30	0.179"	0.066"	0.311"	+/- .016"	98.9
N48-30T-551 ^	8 AWG	168	30	0.160"	0.066"	0.292"	+/- .016"	73.0

\* Multiconductor, shielded and unshielded cables also available. Please contact our design team for your specific application.

\*\* Conductor O.D. is determined when the cable is under tension during the extrusion process. Please request a sample of cable for evaluation prior to making decisions regarding connectors to be used with these cables.

^ Manufactured and tested in accordance with SAE J 1127, however these sizes are not included in the specification.

**Reference documents:** ASTM B3-specification for soft or annealed copper wire; ASTM B 33-specification for tinned soft or annealed copper for electrical purposes; ASTM B 286-specification for copper conductors in hook-up wire for electronic equipment; SAE J 1127-Battery cable; SAE J 1654-High voltage primary cable and UL 1581 Standard for Safety of Electrical Wires, Cables and Flexible cords.

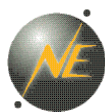

# GLOSSARY OF TERMS

**ABRASION RESISTANCE** Ability of a wire, cable or material to resist surface wear.

**ALLOY** A metal formed by combining two or more different metals to obtain desirable properties.

**ALTERNATING CURRENT (AC)** Electric current that continually reverses its direction. It is expressed in cycles per second (Hertz or Hz).

**AMBIENT TEMPERATURE** The temperature of the medium surrounding an object.

**AMPACITY** The maximum current an insulated wire or cable can safely carry without exceeding either the insulation or jacket material limitations.

**AMPERE** A unit of current; one ampere is the current flowing through one ohm of resistance at one volt potential.

**ANNEAL** To soften and relieve strains of metal by heating to just below melting point then slowly cooling. Annealing lowers the tensile strength of copper, while improving flex life and flexibility.

**ANSI** American National Standards Institute.

**ASA** American Standards Association. Former name of ANSI.

**ASME** American Society of Mechanical Engineers.

**ASTM** American Society for Testing and Materials.

**ATTENUATION** Reduction of signal strength during transmission. In cables, generally expressed in dB per unit length, usually 1000 feet.

**AUDIO FREQUENCY** The range of frequencies audible to the human ear. Usually 20-20,000 Hz.

**AWG** American Wire Gauge.

**AWM** UL designation for appliance wiring material.

**BAND WIDTH** The frequency range of transmitted electrical signals, expressed in Hertz.

**BARE CONDUCTOR** A conductor having no covering, coating or cladding on the copper.

**BEND RADIUS** Radius of curvature that a cable can bend before the risk of breakage or increased attenuation occurs. To determine bend radius a good rule of thumb is not to exceed ten times the cable diameter.

**BINDER** A spirally served tape or thread used to hold cable components in place.

**BOND** The attachment at an interface between an adhesive and an adherent or between materials attached by adhesive.

**BOND STRENGTH** Amount of adhesion between surfaces, e.g., in bonded ribbon cables.

**BRAID** A group of textile or metallic filaments interwoven to form a tubular flexible structure which may be applied over one or more wires or flattened to form a strap.

**BRAID ANGLE** The smaller of the two angles formed by the shielding strand and the axis of the cable being shielded.

**BRAZING** The joining of ends of two wires or groups of wires with a nonferrous filler metal at temperatures in excess of 800°F / 427° C.

[www.newenglandwire.com](http://www.newenglandwire.com)

Tel: 603.838.6624

<b>BREAKDOWN VOLTAGE</b>	The voltage at which insulation between two conductors will fail, allowing electricity to 'arc' or pass through.
<b>B. &amp; S.</b>	Brown & Sharpe Wire Gauge.
<b>BUNCH STRANDING</b>	A group of like wires twisted together without regard to geometric pattern.
<b>BUS-BAR WIRE</b>	Uninsulated tinned copper wire used as a common lead.
<b>C</b>	Celsius.
<b>CABLE ASSEMBLY</b>	A completed cable and its associated hardware ready to install.
<b>CABLE FILLER</b>	Material used in multiconductor cables to occupy interstices in order to produce a cable that is as smooth and round as possible.
<b>CABLING</b>	Grouping or twisting together of two or more insulated conductors to form a cable.
<b>CABLING FACTOR</b>	Used for calculating the overall diameter of a cable when multiple conductors of the same size are cabled together. $D=Kd$ , where D is the cable diameter, K is the factor and d is the diameter of one insulated conductor.
<b>CEC</b>	Canadian Electrical Code; Canada's version of the US National Electrical Code (NEC).
<b>CAPACITANCE</b>	The ability of a dielectric material between conductors to store energy when a difference of potential exists between the conductors. Cable capacitance is usually measured in picofarads (pF) per unit length.
<b>CATEGORY</b>	Rating of a cable established by TIA/EIA to indicate the level of electrical performance.
<b>CATHODE</b>	Negative pole of an electric source.
<b>CATV</b>	Community Antenna Television.
<b>CCTV</b>	Closed Circuit Television.
<b>CELLULAR POLYETHYLENE</b>	Foamed polyethylene consisting of individual closed cells suspended in a polyethylene medium, resulting in a desirable reduction of the dielectric constant.
<b>CHARACTERISTIC IMPEDANCE</b>	The ratio of voltage to current at every point along a transmission line at the point the voltage is applied. The impedance which makes a transmission cable seem infinitely long, when connected across the cable's output terminals.
<b>CIGARETTE WRAP</b>	Tape insulation wrapped longitudinally instead of spirally over a conductor
<b>CIRCULAR MIL</b>	The area of a circle one one-thousandth of an inch (.001") in diameter. Used in expressing wire cross sectional area and to determine conductivity and gauge size that various combinations of conductors will produce.
<b>CLADDING</b>	Method of applying a layer of metal over another metal whereby the junction of the two metals is continuously welded.
<b>COAXIAL CABLE</b>	Cable consisting of two cylindrical conductors with a common axis, separated by a dielectric.
<b>COLD BEND</b>	A cold chamber test to determine effects of specified temperatures on cable which has been wrapped around a mandrell.
<b>COLDflex GROUND CABLE™</b>	New England Wire's flexible low-temperature ground cable for power distribution applications.
<b>COLD FLOW</b>	Permanent deformation of the insulation due to mechanical force or pressure.
<b>COLOR CODE</b>	A system for identifying components of cables using solid color and striped jackets.





<b>COMMON AXIS CABLING</b>	In multiconductor cables, a twisting of all conductors around a common axis yielding smaller diameter constructions.
<b>COMPACTED STRANDED CONDUCTOR</b>	A unidirectional or conventional concentric conductor manufactured to a specified diameter which is approximately 8 to 10% less than the nominal diameter the standard stranded conductor.
<b>COMPOSITE CABLE</b>	A cable consisting of two or more different types or sizes of wires.
<b>COMPOUND</b>	An insulating or jacketing material made by mixing two or more ingredients.
<b>CONCENTRIC STRANDING</b>	A group of uninsulated wires twisted around a center core with subsequent layers spirally wrapped around the core, alternating lay directions, to form a single conductor.
<b>CONCENTRICITY</b>	The measurement of the location of the center of a conductor with respect to the geometric center of the surrounding insulation.
<b>CONDUCTANCE</b>	The ability of a conductor to carry electric current; reciprocal of resistance. Measured in mhos (ohm backwards).
<b>CONDUCTIVITY</b>	The capability of material to carry electrical current, expressed as a percentage of copper conductivity with copper being 100%.
<b>CONDUCTOR</b>	A substance, usually metal, used to transfer electrical energy from point to point.
<b>CONDUIT</b>	A tube in which insulated wire and cables are run.
<b>CONNECTOR</b>	A device used to physically and electrically connect two or more conductors.
<b>CONTACT</b>	The part of a connector that actually carries the electrical current; two contacts are touched together or separated to control the flow.
<b>CONTINUITY CHECK</b>	A test to determine whether electric current flows continuously throughout the length of a single wire or individual wires in a cable.
<b>COPOLYMER</b>	A polymer formed from two or more types of monomer.
<b>COPPER-CLAD STEEL</b>	Steel with a coating of copper welded to it; same as Copperweld.
<b>COPPERWELD</b>	Trade name of Flexo Wire Division (Copperweld Steel Corp.) for their copper-clad steel conductors.
<b>CORE</b>	A component(s) over which additional components (shield, sheath, etc.) are applied.
<b>CORONA</b>	A discharge due to ionization of air around a conductor due to a potential gradient exceeding a certain critical value.
<b>CORROSION</b>	Deterioration of material by chemical reaction of galvanic action.
<b>CRAZING</b>	The minute cracks on the surface of plastic materials.
<b>CROSS-LINKED</b>	Inter-molecular bonds between long chain thermoplastic polymers by chemical or electron bombardment means. The properties of the resulting thermosetting materials are usually improved.
<b>CROSSTALK</b>	The coupling of unwanted signals from one pair within a cable to another pair. Crosstalk can be measured at the same (near) end or far end with respect to the signal source.
<b>C.S.A.</b>	Canadian Standards Association; the Canadian counterpart of Underwriters Laboratories.
<b>CURRENT</b>	The rate of flow of electricity in a circuit, measured in amperes.
<b>CURRENT-CARRYING CAPACITY</b>	Maximum current an insulated conductor or cable can continuously carry without exceeding its temperature rating; also called ampacity.

<b>CUT-THROUGH</b>	A test to determine the ability of a material to withstand the application of blades or sharp edges without being cut.
<b>DC</b>	Direct current.
<b>DECIBEL (dB)</b>	A unit of measure to express power gaining amplifiers or power loss in passive circuits of cables.
<b>DERATING FACTOR</b>	Factor used to reduce current carrying capacity of a wire when used in environments other than that for which the value was established.
<b>DIELECTRIC</b>	A nonconducting insulating material that permits electrostatic attraction and repulsion to occur.
<b>DIELECTRIC BREAKDOWN</b>	A change in the properties of a dielectric that causes it to become conductive.
<b>DIELECTRIC CONSTANT (K)</b>	The property of a dielectric which determines the amount of electrostatic energy that can be stored by the material when a given voltage is applied to it. Also called permattivity.
<b>DIELECTRIC LOSS</b>	The power dissipated in a dielectric as the result of the friction produced by molecular motion when an alternating electric field is applied.
<b>DIELECTRIC STRENGTH</b>	The voltage which an insulation can withstand before breakdown occurs. Usually expressed as a voltage gradient (such as volts per mil).
<b>DIELECTRIC TEST</b>	A test in which a voltage higher than the rated voltage is applied for a specified time to determine the adequacy of the insulation under normal conditions.
<b>DIRECT CURRENT (DC)</b>	An electric current which flows in only one direction.
<b>DRAIN WIRE</b>	A non-insulated wire in contact with the shield and used in termination to that shield as a ground connection.
<b>DRAWING</b>	Pulling metal through a die or series of dies to reduce the diameter to a specific size. New England Wire draws wire to 50 AWG for its manufacturing processes.
<b>ECCENTRICITY</b>	A measure of the center of a conductor's location with respect to the circular cross section of the insulation. Expressed as a percentage of displacement of one circle within another.
<b>EIA</b>	Electronic Industries Association.
<b>ELASTOMER</b>	Any material that will return to its original dimensions after being stretched or distorted.
<b>ELECTROMAGNETIC</b>	Pertaining to the combined electric and magnetic fields associated with movements of electrons through conductors.
<b>ELECTROMOTIVE FORCE (e.m.f.)</b>	Pressure or voltage; the force that causes current to flow in a circuit.
<b>ELECTROSTATIC</b>	Pertaining to static electricity or electricity at rest.
<b>ELFEXT</b>	Equal Level Far End Crosstalk (dB). A subtraction of attenuation from FEXT. ELFEXT negates the effect of attenuation on the interference as it propagates down the cable, thus bringing it to an "equal level".
<b>ELONGATION</b>	An increase in the length of a wire or cable caused by longitudinal tension.
<b>EMI</b>	Electromagnetic interference.
<b>ELECTROLYTIC TOUGH PITCH (ETP)</b>	Copper refining process that produces a conductor that is 99.9% pure copper resulting in high conductivity.



<b>ETFE</b>	Ethylene tetrafluoroethylene. An alternating copolymer consisting of ethylene and tetrafluoroethylene segments. High impact resistance with useful mechanical properties up to 200° C.
<b>EXTRUDED CABLE</b>	Conductors are simultaneously insulated and the cable is formed by a continuous extrusion process.
<b>EXTRUSION</b>	The process of continuously forcing both a plastic or elastomer and a conductor through a die, thereby applying a continuous coating of insulation or jacket to the core.
<b>FARAD</b>	A unit of electrical capacity.
<b>FEP</b>	Fluorinated ethylene-propylene. A thermoplastic with excellent dielectric properties as well as chemical and heat resistance.
<b>FILLER</b>	Nonconducting components cabled with insulated conductors to impart roundness, flexibility, tensile strength, or a combination of all three, to the cable.
<b>FLAME RESISTANCE</b>	The ability of a material not to fuel a flame once the source of heat is removed.
<b>FLAME RETARDANCE</b>	Ability of a material to prevent the spread of combustion by a low rate of travel so the flame will not be propagated.
<b>FLAMMABILITY RATING</b>	The measure of the material's ability to support combustion.
<b>FLAT BRAID</b>	A woven braid, usually tinned copper, which is flattened at time of manufacturing to a specific width.
<b>FLEX LIFE</b>	The measurement of the ability of a conductor or cable to withstand repeated bending.
<b>FLEXIBILITY</b>	The ease with which a cable may be bent.
<b>FLUOROPOLYMERS</b>	High-temperature plastics with excellent electrical properties. New England Wire most frequently uses ETFE, FEP and PFA.
<b>FOAMED DIELECTRIC</b>	Using highly controlled extrusion processes, materials are foamed resulting in a significantly reduced dielectric constant (1.45 - 1.8) that approaches the nearly ideal properties of air without sacrificing structural integrity.
<b>GAS OUT</b>	A hole blown in the jacket of a cable during the extrusion process.
<b>GAUGE</b>	A term used to describe the physical size of a wire. As the AWG number gets smaller, the diameter of the wire gets larger.
<b>GROUND</b>	A conducting connection between an electrical circuit and the earth or other large conducting body to serve as an earth thus making a complete electrical circuit.
<b>HDPE</b>	High Density Polyethylene.
<b>HALOGEN</b>	Any of the five elements: fluorine, chlorine, bromine, iodine and astatine. These elements may be combined with insulation compounds to enhance flame retardancy.
<b>HARD DRAWN COPPER WIRE</b>	Copper wire that has not been annealed after drawing.
<b>HARNESS</b>	An arrangement of wires and cables which have been tied together or pulled into a rubber or plastic sheath, used to interconnect an electric circuit.
<b>HEAT SEAL</b>	A method for sealing by thermal fusion.
<b>HELICAL STRIPE</b>	A continuous, colored, spiral stripe applied to a conductor for circuit identification.

<b>HENRY</b>	Unit of inductance such that the induced voltage in volts is numerically equal to the rate of change in current in amperes per second.
<b>HERTZ (Hz)</b>	A term replacing cycles-per-second as a unit of frequency.
<b>HI-POT</b>	Short for High Potential. A test designed to determine the electrical integrity of an insulation.
<b>HOOK-UP WIRE</b>	A single insulated conductor used for low-current, low voltage (usually under 600 volts) applications within enclosed electronic equipment.
<b>HOT TIN DIP</b>	The process of passing bare wire through a bath of molten tin to provide a coating.
<b>HYDROSCOPIC</b>	A type of material that absorbs some water from the air around it.
<b>HYFLEX™ POWER DISTRIBUTION CABLES</b>	New England Wire Technologies' proprietary power distribution cable designed for diesel hybrid vehicles. Using high performance compounds specifically formulated for use in surface vehicle electrical systems operating at temperatures up to 125°C and voltages up to 600 V AC. Available in sizes 8 AWG through 250 kCMA.
<b>HYBRID CABLE</b>	An assembly of two or more cables (of the same or different types or categories) covered by one overall sheath.
<b>HYGROSCOPIC</b>	Capable of absorbing and retaining moisture.
<b>IEEE</b>	Institute of Electrical and Electronics Engineers.
<b>IMPEDANCE</b>	The total opposition that a circuit offers to the flow of alternating current or any other varying current at a particular frequency; measured in ohms.
<b>INDUCTANCE</b>	The property of a circuit or circuit element that opposes a change in current flow, thus causing current changes to lag behind voltage changes. It is measured in henrys.
<b>INSULATION</b>	Material having good dielectric properties used to separate close electrical components, such as cable conductors and circuit components.
<b>INSULATION RESISTANCE (I.R.)</b>	Resistance to current leakage through the insulation materials.
<b>INSULATION THICKNESS</b>	Wall thickness of the applied insulation.
<b>INTERFERENCE</b>	Any undesired electrical signal introduced into a conductor by electrical or electromagnetic means.
<b>INTERSTICES</b>	Voids or valleys between individual strands in a conductor or between insulated conductors in a multiconductor cable.
<b>IRRADIATION</b>	In insulations, the exposure of the material to high energy emissions for the purpose of favorably altering the molecular structure by crosslinking.
<b>ISO</b>	International Standards Organization. New England Wire Technologies is an ISO 9001:2000 registered company.
<b>JACKET</b>	The outer protective covering of a wire and cable product; may also provide additional insulation.
<b>KILO</b>	A numerical prefix denoting 1000 (10 <sup>3</sup> ).
<b>LAMINATED TAPE</b>	Tape consisting of two or more layers of different materials bonded together.
<b>LAN</b>	Local Area Network.
<b>LAY</b>	The axial distance required for one cabled conductor or conductor strand to complete one revolution about the axis around which it is cabled.



<b>LAY DIRECTION</b>	The direction of the progressing spiral twist in a cable while looking along the axis of the cable away from the observer. The lay direction can either be 'S' (left) or 'Z'(right).
<b>LEAKAGE CURRENT</b>	The undesirable flow of current through or over the surface of an insulation.
<b>LIFE CYCLE</b>	A test to determine the length of time before failure in a controlled, usually accelerated, environment.
<b>LITZ WIRE</b>	A stranded (bunched) or cabled conductor made of magnet wire in which each strand is insulated from every other strand.
<b>LONGITUDINAL SHIELD</b>	A tape shield, flat or corrugated, applied longitudinally with the axis of the core being shielded.
<b>LOW LOSS DIELECTRIC</b>	An insulation material that has a relatively low dielectric loss, such as polyethylene or a fluoropolymer.
<b>LOW NOISE CABLE</b>	Cable specifically designed to neutralize noise generated by mechanical shock and vibration and maximize signal quality in small-signal applications. New England Wire Technologies' product line uses NEWtral® technology.
<b>MAGNETIC FIELD</b>	The region within which a body or current experiences magnetic forces.
<b>MCM</b>	One thousand circular mils.
<b>MHz</b>	Megahertz; one million cycles per second.
<b>MICROPHONICS</b>	Electrical noise in a system caused by mechanical vibrations.
<b>MIL</b>	Unit used to measure diameter of a wire or thickness of insulation over a conductor. One one-thousandth of an inch (.001").
<b>MYLAR</b>	DuPont trademark name for polyethylene terephthalate (polyester) material used in form of tape.
<b>NATIONAL ELECTRICAL CODE (NEC)</b>	A consensus standard published by the National Fire Protection Association (NFPA) and incorporated in OSHA regulations.
<b>NE-F1</b>	New England Wire Technologies' Class F (155°C) Electrical Insulation System. OBJS2 File E231977, Component IEC 60085, CAN/CSA C22.2 No. 0-M91, Appendix B. Approved for use in the construction of transformers, motors and coils.
<b>NEMA</b>	National Electrical Manufacturers Association.
<b>NEOPRENE</b>	A synthetic rubber with good resistance to oil, chemical, and flame. Also called polychloroprene.
<b>NEWcel®</b>	A closed-cell foamed dielectric material specifically designed by New England Wire Technologies to reduce dielectric constant and dissipation factor yielding low-capacitance, low-loss, high V.O.P. ultraminiature coaxial, triaxial and twinaxial cables.
<b>NEWguard™</b>	New England Wire Technologies' proprietary cables designed for the most challenging environmental challenges—extreme temperatures, mechanical abuse and exposure to chemicals, oils, dust, wind, salt water spray and vibration.
<b>NEWlan™</b>	New England Wire Technologies' line of networking cables.
<b>NEWtral®</b>	A low-noise cable designed by New England Wire Technologies to neutralize noise generated by mechanical shock and vibration and to maximize signal quality in small-signal applications.
<b>NEWtuf®</b>	New England Wire Technologies' proprietary silicone rubber jacket specifically designed to provide high axial tensile strength while maintaining superior flexibility and high temperature performance.
<b>NEWind®</b>	A specialty winding wire designed by New England Wire Technologies to eliminate additional ground, interwinding and turn insulation in motors and transformers reducing cost and size.

- NEXT** Near End Crosstalk (dB). Crosstalk induced on the pairs, measured at the end “near” the transmitter.
- NOISE** Unwanted and/or unintelligible signals picked up on a cable circuit.
- NOMEX** Dupont trademark for a temperature-resistant, flame retardant nylon.
- NYLON** An abrasion-resistant thermoplastic with good chemical resistance.
- OFHC** Oxygen-free high-conductivity copper (OFHC) has 99.95% minimum copper content with an average conductivity in the annealed state of 101%.
- OHM** Unit of measure for electrical resistance. The value of resistance through which a potential difference of one volt will maintain a current of one ampere.
- OVERALL DIAMETER** Finished diameter of a wire or cable.
- OVERLAP** The amount the trailing edge laps over the leading edge of a tape wrap.
- OXYGEN INDEX** Percentage of oxygen necessary to support combustion of a specified material.
- PAIR** Two insulated wires of a single circuit associated together.
- PATCH CABLE** A flexible piece of cable terminated at both ends with connectors. Used for interconnecting circuits on a patch panel or cross connect.
- PE** Polyethylene.
- PERCENT CONDUCTIVITY** Conductivity of a material expressed as a percentage of that of copper.
- PFA - PERFLUOROALKOXY** A melt processible insulation with excellent thermal and electrical insulation properties including resistance to practically all chemicals, resistance to weathering, and low friction coefficient.
- PICK** The distance from the intersection of two opposing groups of wires to the next corresponding intersection along the length of the braid. The number of picks per inch determines the density of the braid pattern.
- PICKS PER INCH (P/I)** The number of times the carriers in a braid cross over each other in the same direction along the longitudinal axis for each inch of length.
- PITCH** In flat cable, the nominal distance between the index edges of two adjacent conductors.
- PLASTICIZER** A chemical agent added to plastics to make them softer and more pliable.
- PLENUM CABLE** Cable approved by Underwriters Laboratories for installation in plenums without the need for conduit.
- POLYETHYLENE (PE)** A thermoplastic material having excellent electrical properties, low dielectric constant, and very high insulation resistance. Can be stiff to very hard, depending on molecular weight and density. Moisture resistance is rated excellent.
- POLYAMIDE** A compound characterized by more than amide group. See nylon.
- POLYIMIDE** Available for high-temperature wire insulation in both tape form and as a film coating.
- POLYMER** A substance made of many repeating chemical units or molecules. The term polymer is often used in place of plastic, rubber or elastomer.
- POLYOLEFIN** Any of the polymers and copolymers of the ethylene family of hydrocarbons, such as polyethylene and polypropylene.



- POLYPROPYLENE** A thermoplastic similar to polyethylene but stiffer and having a higher softening point (temperature). This material is used primarily as an insulation material. Typically, it is harder than polyethylene which makes it suitable for thin wall insulations.
- POLYURETHANE** A class of polymers noted for good abrasion and solvent resistance as well as outstanding 'memory' properties, making it an ideal jacket material for retractile cords. Some formulations also have good flame resistance.
- POLYVINYL CHLORIDE (PVC)** A thermoplastic material composed of polymers of vinyl chloride which may be rigid or elastomeric, depending on specific formulation.
- PRIMARY INSULATOR** The first layer of nonconductive material applied over a conductor. Its function is to act as an electrical insulation.
- PUT-UP** Packaging of finished wire or cable.
- RATED TEMPERATURE** The maximum temperature at which an electric component can operate for extended periods without undue degradation or safety hazard.
- RATED VOLTAGE** The maximum voltage at which an electric component can operate for extended periods without undue degradation or safety hazard.
- REACTANCE** A measure of the combined effects of capacitance and inductance on an alternating current. The amount of such opposition varies with the frequency of the current. The reactance of a capacitor decreases with an increase in frequency. The opposite occurs with an inductance.
- RESISTANCE** In DC circuits, the opposition a material offers to current flow, measured in ohms. In AC circuits, resistance is the real component of impedance and may be higher than the value measured at DC.
- RETRACTILE CABLE** A coiled cable that returns by its own stored energy from an extended condition to its original retracted form.
- RFI** Radio Frequency Interference.
- RIP CORD** A cord placed directly under the jacket of a cable in order to facilitate stripping (removal) of the jacket.
- RoHS** Restricting the use of Hazardous Substances. A European directive that restricts the use of certain hazardous substances during manufacture of electronic/electrical products and components.
- ROPELAY CABLE** A cable composed of a central core surrounded by one or more layers of helically laid groups of wires.
- RIBBON CABLE** A flat cable of individually insulated conductors laid parallel and held together by extrusion, bonding or woven textile yarn.
- SAE** Society of Automotive Engineers.
- SERVE** A filament or group of filaments such as fibers or wires, wound around a central core.
- SHIELD** A tape, serve or braid (usually copper, aluminum or other conductive metal) placed around or between electric circuits or cables or their components, to prevent signal leakage or interference.
- SHIELD COVERAGE** The physical area of a cable that is actually covered by shielding material; expressed in percent.
- SHIELD EFFECTIVENESS** The relative ability of a shield to screen out undesirable signals.
- SILICONE RUBBER** Jacketing material made from silicone and oxygen. Noted for high heat resistance and excellent electrical properties plus ozone resistance, low moisture absorption, weather resistance and radiation resistance.

<b>SKIN EFFECT</b>	The tendency of alternating current, as its frequency increases, to travel only on the surface of a conductor.
<b>SPARK TEST</b>	A test designed to locate imperfections (usually pinholes in the insulation of a wire or cable) by application of a voltage for a very short period of time while the wire is being drawn through the electrode field.
<b>SPECIFIC GRAVITY</b>	The ratio of the density (mass per unit volume) of a material to that of water.
<b>SPIRAL WRAP</b>	The helical wrap of a material over a core; also referred to as a serve.
<b>SPLICE</b>	A joining of conductors generally from separate sheaths.
<b>STRANDED CONDUCTOR</b>	A conductor composed of individual groups of wires twisted together to form a larger conductor.
<b>STRIP FORCE</b>	The force required to remove a small section of insulating material from the conductor it covers.
<b>TAPE WRAP</b>	A spirally applied tape over an insulated or uninsulated wire.
<b>TEAR STRENGTH</b>	The force required to initiate or continue a tear in a material under specific conditions.
<b>TEMPERATURE RATING</b>	The maximum temperature at which an insulating material may be used in continuous operation without loss of its basic properties.
<b>TENSILE STRENGTH</b>	The pull stress required to break a given specimen.
<b>TFE (TETRAFLUOROETHYLENE)</b>	A thermoplastic material with good electrical insulating properties, chemical and heat resistance. Rated to 260° C.
<b>THERMOCOUPLE</b>	A device consisting of two dissimilar metals in physical contact, which when heated will develop an emf output.
<b>THERMOPLASTIC</b>	A material which hardens or sets by heat, chemical or radiation cross-linking techniques and which, once set, cannot be resoftened by heating.
<b>TIA/EIA 568A</b>	Commercial Building Telecommunications Wiring Standard that defines a generic telecommunications wiring system for commercial buildings that will support a multi-product, multi-vendor environment. It also provides direction for the design of telecommunications products for commercial enterprises.
<b>TIN OVERCOAT (TOC)</b>	Tinned copper wire, stranded and then coated with tin.
<b>TINSEL</b>	A type of electrical conductor comprised of a number of threads, each thread having a fine, flat ribbon of copper or other metal closely spiralled about it. Used for small size cables requiring flexibility and long flex life.
<b>TOPCOAT</b>	Bare (untinned) copper wire, stranded and then coated with tin.
<b>TRANSFER IMPEDANCE</b>	The ratio of internal longitudinal voltage to external current flow on the cable shield; used to determine shield effectiveness against both the ingress and egress of interfering signals.
<b>TRIAxIAL CABLE/TRIAx</b>	A coax cable with an additional outer shield insulated from signal carrying conductors. It has a core conductor and two concentric conductive shields.
<b>TRIBOELECTRIC NOISE</b>	Noise generated in a shielded cable due to variations in capacitance between shielding and conductor as the cable is flexed.
<b>TWINAX OR TWINAXIAL CABLE</b>	A type of communication transmission cable consisting of two center conductors surrounded by an insulating spacer, which in turn is surrounded by a tubular outer conductor (usually a braid, foil or both). The entire assembly is then covered with an insulating and protective outer layer. It is similar to coaxial cable except that there are two conductors at the center.





- TWISTED PAIR** Two insulated conductors twisted together.
- TWISTED TRIAD** Any three individually insulated conductors which are twisted together.
- UL** Underwriters Laboratories; a nonprofit organization which tests and verifies construction and performance of electronic parts and equipment.
- UNILAY** More than one layer of helically laid wires with the direction and length of lay the same for all.
- VELOCITY OF PROPAGATION** The speed of an electrical signal down a length of cable compared to speed in free space expressed as a percent. It is the reciprocal of the square root of the dielectric constant of the cable insulation.
- VHF** Very High Frequency, 30 to 300 MHz.
- VOLT** A unit of electrical pressure. One volt is the amount of pressure that will cause one ampere of current in one ohm of resistance.
- VOLTAGE** Electrical potential or electromotive force expressed in volts.
- VOLTAGE RATING** The highest voltage that may be continuously applied to a wire in conformance with standards or specifications.
- WALL** The thickness of the applied insulation or jacket.
- WATT** A unit of electrical power. One watt is equivalent to the power represented by one ampere of current under a pressure of one volt in DC circuit.
- WICKING** The longitudinal flow of liquid in a wire or cable due to capillary action.
- ZIP CORD** Two or more independently insulated conductors in a parallel configuration that can easily be pulled apart leaving the insulation of each conductor intact. May be extruded together or extruded independently and later bonded together.